

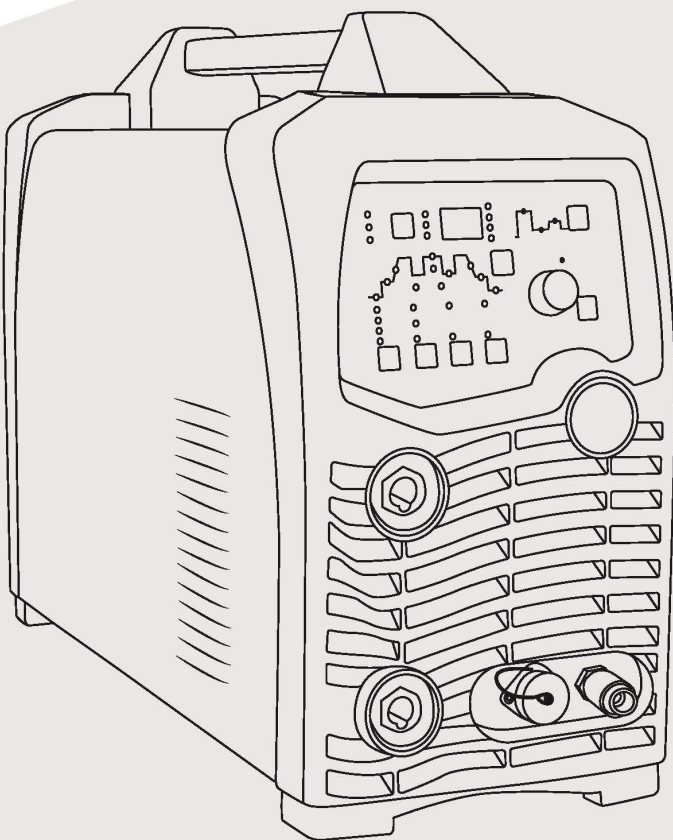

TIG Series

TIG 300 Pulse (JT-300P)

TIG 300 Pulse Water Cooled
(JT-300P-WC)



Operator Manual



Your new product

Thank you for selecting this Jasic product.

This product manual has been designed to ensure that you get the most from your new product. Please ensure that you are fully conversant with the information provided paying particular attention to the safety precautions. The information will help protect yourself and others against the potential hazards that you may come across.

Please ensure that you carry out daily and periodic maintenance checks to ensure years of reliable and trouble free operation.

Please call your Jasic distributor in the unlikely event of a problem occurring. Please record below the details from your product as these will be required for warranty purposes and to ensure you get the correct information should you require assistance or spare parts.

Date purchased _____

From where _____

Serial number _____

(The serial number is normally located on the top or underside of the machine and will begin with AA).

For further information on your Jasic product warranty registration please visit:

www.jasic-warranty.co.uk

Disclaimer

Whilst every effort has been made to ensure that the information contained within this manual is complete and accurate, no liability can be accepted for any errors or omissions.

Please note:

Products are subject to continual development and may be subject to change without notice. Regularly check our product pages at www.Jasic.co.uk for revision updated operating manuals.

No part of this manual may be copied or reproduced by any means without the written permission of Wilkinson Star Limited.

CONTENTS

Index	Page
Your New Product	2
Index	3
Safety Instruction	4
General electrical safety	4
General operating safety	4
PPE	5
Welding processes lens shade selector guide	5
Fume and welding gases	6
Fire risks	6
The working environment	7
Protection from moving parts	7
Magnetic fields	7
Compressed gas cylinders and regulators	7
RF declaration	8
LF declaration	8
Materials and their disposal	8
Product Overview	9
Technical Specifications	10
Description of Controls	11
Description of Functions	13
Installation	17
Operation MMA	24
Operation TIG	26
Remote Control Socket	34
Guide to MMA Welding	35
MMA Welding Problems	39
Guide to TIG Welding	40
TIG Welding Torch	48
TIG Welding Problems	50
Maintenance	52
Service Schedule Record	53
Troubleshooting	54
WEEE Disposal	55
RoHS Compliance Declaration	55
UKCA Declaration of Conformity	55
EC Declaration of Conformity	56
Statement of Warranty	57
Options and Accessories	58
Notes	59
Jasic Contact Details	60

SAFETY INSTRUCTION

These general safety norms cover both arc welding machines and plasma cutting machines unless otherwise noted.

It is important that users of this equipment protect yourselves and others from harm or even death. The equipment must only be used for the purpose it was designed for. Using it in any other way could result in damage or injury and in breach of the safety rules.

Only suitably trained and competent persons should use the equipment.

Pacemaker wearers should consult your doctor prior to using this equipment.

PPE and workplace safety equipment must be compatible for the application of work involved.

Always carry out a risk assessment before undertaking any welding or cutting activity

General electrical safety



The equipment should be installed by a qualified person and in accordance with current standards in accordance with current standards in operation. It is the users responsibility to ensure that the equipment is connected to a suitable power supply. Consult with your utility supplier if required. Do not use the equipment with the covers removed.

Do not touch live electrical parts or parts which are electrically charged.

Turn off all equipment when not in use.

In the case of abnormal behaviour of the equipment, the equipment should be checked by a suitably qualified service engineer.

If earth bonding of the work piece is required, bond it directly with a separate cable with a current carrying capacity capable of carrying the maximum capacity of the machine current.

Cables (both primary supply and welding) should be regularly checked for damage and overheating.

Never use worn, damaged, under sized or poorly jointed cables.

Insulate yourself from work and earth using dry insulating mats or covers big enough to prevent any physical contact.

Never touch the electrode if you are in contact with the work piece return.

Do not wrap cables over your body.

Ensure that you take additional safety precautions when you are welding in electrically hazardous conditions such as damp environments, wearing wet clothing and metal structures.

Try to avoid welding in cramped or restricted positions.

Ensure that the equipment is well maintained. Repair or replace damaged or defective parts immediately.

Carry out any regular maintenance in accordance with the manufacturers instructions.

The EMC classification of this product is class A in accordance with electromagnetic compatibility standards CISPR 11 and IEC 60974-10 and therefore the product is designed to be used in industrial environment only.

WARNING: This class A equipment is not intended for use in residential locations where the electrical power is provided by a public low-voltage supply system. In those locations it may be difficult to ensure the electromagnetic compatibility due to conducted and radiated disturbances.

General operating safety

Never carry the equipment or suspend it by the carrying strap or handles during welding.

Never pull or lift the machine by the welding torch or other cables. Always use the correct lift points or handles. Always use the transport under gear as recommended by the manufacturer.

Never lift a machine with the gas cylinder mounted on it.

If the operating environment is classified as dangerous, only use S-marked welding equipment with a safe idle voltage level. Such environments may be for example: humid, hot or restricted accessibility spaces.

SAFETY INSTRUCTION

Use of Personal Protective Equipment (PPE)

Welding arc rays from all welding processes produce intense, visible and invisible (ultraviolet and infrared) rays that can burn eyes and skin.

- Wear an approved welding helmet fitted with an appropriate shade of filter lens to protect your face and eyes when welding or watching.
- Wear approved safety glasses with side shields under your helmet.
- Never use broken or faulty welding helmets.
- Always ensure there are adequate protective screens or barriers to protect others from flash, glare and sparks from the welding area.
- Ensure that there are adequate warnings that welding or cutting is taking place.
- Wear suitable protective flame resistant clothing, gloves and footwear.
- Check and be sure the area is safe and clear of inflammable material before carrying out any welding.

Some welding and cutting operations may produce noise. Wear safety ear protection to protect your hearing if the ambient noise level exceeds the local allowable limit (e.g: 85 dB).



Welding and Cutting Lens Shade Selector Guide

CURRENT	MMA ELECTRODES	MIG LIGHT ALLOYS	MIG HEAVY METALS	MAG	TIG ON ALL METALS	PLASMA CUTTING	PLASMA WELDING	GOUGING ARC/AIR
10	8							
15								
20	9	10	10	10	10			
30								
40	10					11	11	10
60								
80	11	11	11	12	11			
100								
125	12	12	12	13	12		13	11
150								
175	13	13	13	14	13			12
200								
225	14	14	14	15	14	13	14	13
250								
275	15	15	15	16	15			14
300								
350	16	16	16	17	16			15
400								
450	17	17	17	18	17			16
500								

SAFETY INSTRUCTION

Safety against fumes and welding gases



Warning
Fumes and
Gases

The HSE have identified welders as being an 'at risk' group for occupational diseases arising from exposure to dusts, gases, vapours and welding fumes. The main identified health effects are pneumonia, asthma, chronic obstructive pulmonary disease (COPD), lung and kidney cancer, metal fume fever (MFF) and lung function changes.

During welding and hot cutting 'hot work' operations, fumes are produced which are collectively known as welding fume. Depending upon the type of welding process being performed, the resultant fume generated is a complex and highly variable mixture of gases and particulates.

Regardless of the length of welding being carried out, all welding fume, including mild steel welding requires suitable engineering controls to be in place which is usually Local Exhaust Ventilation (LEV) extraction to reduce the exposure to welding fume indoors and where LEV does not adequately control exposure it should also be enhanced by using suitable respiratory protective equipment (RPE) to assist with protecting against residual fume.

When welding outdoors appropriate RPE should be used.

Prior to undertaking any welding tasks an appropriate risk assessment should be carried out to ensure expected control measures are in place.

Locate the equipment in a well-ventilated position and keep your head out of the welding fume.

Do not breathe the welding fume.

Ensure the welding zone is well-ventilated and provision should be made for suitable local fume extraction system to be in place.

If ventilation is poor, wear an approved airfed welding helmet or respirator.

Read and understand the Material Safety Data Sheets (MSDS's) and the manufacturer's instructions for metals, consumable, coatings, cleaners and de-greasers.

Do not weld in locations near any de-greasing, cleaning or spraying operations.

Be aware that heat and rays of the arc can react with vapours to form highly toxic and irritating gases.

For further information please refer to the HSE website www.hse.gov.uk for related documentation.



An example of personal fume protection

Precautions against fire and explosion



Warning
Fire Risk

Avoid causing fires due to sparks and hot waste or molten metal.

Ensure that appropriate fire safety devices are available near the welding and cutting area.

Remove all flammable and combustible materials from the welding, cutting and surrounding areas.

Do not weld or cut fuel and lubricant containers, even if empty. These must be carefully cleaned before they can be welded or cut.

Always allow the welded or cut material to cool before touching it or placing it in contact with combustible or flammable material.

Do not work in atmospheres with high concentrations of combustible fumes, flammable gases and dust. Always check the work area half an hour after cutting to make sure that no fires have begun.

Take care to avoid accidental contact of electrode to metal objects. This could cause arcs, explosion, overheating or fire.



Understand your fire extinguishers

SAFETY INSTRUCTION

The Working environment

Ensure the machine is mounted in a safe and stable position allowing for cooling air circulation.

Do not operate equipment in an environment outside the laid down operating parameters.

The welding power source is not suitable for use in rain or snow.

Always store the machine in a clean, dry space.

Ensure the equipment is kept clean from dust build up.

Always use the machine in an upright position.

Protection from moving parts

When the machine is in operation keep away from moving parts such as motors and fans.

Moving parts, such as the fan, may cut fingers and hands and snag garments.

Protections and coverings may be removed for maintenance and controls only by qualified personnel after first disconnecting the power supply cable.

Replace the coverings and protections and close all doors when the intervention is finished and before starting the equipment.

Take care to avoid getting fingers trapped when loading and feeding wire during set up and operation.

When feeding wire be careful to avoid pointing it at other people or towards your body.

Always ensure machine covers and protective devices are in operation.

Risks due to magnetic fields



The magnetic fields created by high currents may affect the operation of pacemakers or electronically controlled medical equipment.

Wearers of vital electronic equipment should consult their physician before beginning any arc welding, cutting, gouging or spot welding operations.

Do not go near welding equipment with any sensitive electronic equipment as the magnetic fields may cause damage.

Keep the torch cable and work return cable as close to each other as possible throughout their length.

This can help minimise your exposure to harmful magnetic fields.

Do not wrap the cables around the body.

Handling of compressed gas cylinders and regulators

Mishandling gas cylinders can lead to rupture and the release of high pressure gas.

Always check the gas cylinder is the correct type for the welding to be carried out.

Always store and use cylinders in an upright and secure position.

All cylinders and pressure regulators used in welding operations should be handled with care.

Never allow the electrode, electrode holder or any other electrically “hot” parts to touch a cylinder.

Keep your head and face away from the cylinder valve outlet when opening the cylinder valve.

Always secure the cylinder safely and never move with regulator and hoses connected.

Use a suitable trolley for moving cylinders.

Regularly check all connections and joints for leaks.

Full and empty cylinders should be stored separately.

Never deface or alter any cylinder

SAFETY INSTRUCTION

RF Declaration

Equipment that complies with directive 2014/30/EU concerning electromagnetic compatibility (EMC) and the technical requirements of EN60974-10 is designed for use in industrial buildings and not those for domestic use where electricity is provided via the low voltage public distribution system.

Difficulties may arise in assuring class A electromagnetic compatibility for systems installed in domestic locations due to conducted and radiated emissions.

In the case of electromagnetic problems, it is the responsibility of the user to resolve the situation.

It may be necessary to shield the equipment and fit suitable filters on the mains supply.

LF Declaration

Consult the data plate on the equipment for the power supply requirements.

Due to the elevated absorbance of the primary current from the power supply network, high power systems affect the quality of power provided by the network. Consequently, connection restrictions or maximum impedance requirements permitted by the network at the public network connection point must be applied to these systems.

In this case, the installer or the user is responsible for ensuring the equipment can be connected, consulting the electricity provider if necessary.

Materials and their disposal

Welding equipment is manufactured with BSI published standards meeting CE requirements materials which do not contain any toxic or poisonous materials dangerous to the operator.

Do not dispose of the equipment with normal waste. The European Directive 2012/19/EU on Waste Electrical and Electronic Equipment states the electrical equipment that has reached its end of life must be collected separately and returned to an environmentally compatible recycling facility for disposal.

For more detailed information please refer to the HSE website www.hse.gov.uk

PRODUCT OVERVIEW

The Jasic TIG inverter range of welding machines have been designed as integrated and portable welding power supply units incorporating the most advanced IGBT inverter technology in power electronics with easy operation and adjustment due to friendly user interface.

This is a digital DC inverter welder with complete functions, high performance and advanced technology. It is a multi-function welder with DC TIG welding, DC pulsed TIG welding, coated electrode manual welding and TIG spot welding. It can be widely used in the fine welding operations of various types of metal materials except aluminum and aluminum alloy.

The unique electrical structure and air duct design inside the machine can accelerate the dissipating of the heat generated by the power devices, thus increasing the duty cycle of the machine. This design offers “air tight” protection to sensitive controls which provides an effective dust proof and waterproof performance, thus greatly improving the reliability of the machine.

The TIG 300P provides excellent welding performance, rich function integration, high efficiency, small size, light weight and many other features make it able to meet the welding requirements of all types of welding applications.



Jasic TIG 300P Product Features:

- Compact size, lightweight and modern design
- DC TIG welding, DC pulsed TIG welding and shielded metal arc welding (MMA).
- Multiple remote current control options: Foot pedal remote control, digital torch remote control and analog torch remote control.
- Real-time digital display of output current: Displays the output status of the welder.
- Operating status is displayed by LED indicators dynamically and the current operating status is displayed constantly.
- Hot start for manual welding: Enables the arc striking during manual welding to be easier and more reliable starts.
- VRD function: Ensures the personal safety of the operator and prevents electric shock due to high voltage in MMA mode.
- Anti-sticking function: Prevents the welding electrode from sticking to the work piece during welding.
- Auto-adaptive arc force: Improves significantly the welder's performance in extended length welding and makes long distance welding possible.
- Advanced arc striking function: TIG welding supports Lift/contact arc ignition and non-contact arc ignition. A high-voltage arc ignition circuit improves the success rate of high-frequency arc striking.
- Intelligent fan control: Energy efficiency and noise is reduced as the fan runs “on demand”. This reduces the amount of dust that is deposited inside the machine, thus increasing the service.
- Parameter storage: This is the function to save parameters through multiple channels and keep the parameters saved ready for recall at any time.
- Diagnosis and protection system based on ARM enables the machine to conduct a power-on self-test and detect any problems instantly. Multiple protection systems including phase loss protection, over-current protection, over and under voltage protection, overheat protection etc. helps to enhance the service life of the machine.
- Cooling tank interface: Enables the intelligent control on water system so the unit only operates “on demand”.
- High quality tactile finish to mouldings and handle
- Available packages are air cooled or water cooled



TECHNICAL SPECIFICATIONS

Technical Parameter		Unit	TIG 300P
Rated input voltage		V	AC 400V +/- 15%50/60HZ
Input current I _{eff}		A	9.9
Input Power		kVA	9.5 TIG / 8.5MMA
MMA output characteristics	Current output range	A	20 ~ 210
	Arc force current range	A	0 ~ 60
	Hot start current range	A	0 ~ 60
	No load current	V	60
	VRD voltage	V	11.8
TIG output characteristics	Current output range	A	5 – 300
	No load voltage	V	60
	Initial current range	A	5 ~ 300
	Crater current range	A	5 ~ 300
	Peak current range	A	5 ~ 300
	Base current range	A	5 ~ 300
	Pulse frequency range	Hz	0.5 ~ 200
	Pulse duty cycle	%	10 ~ 90
	Pre flow time	S	0 ~ 15
	Post flow time	S	0.5 ~ 15
	Upslope time	S	0 ~ 10
	Downslope time	S	0 ~ 10
	Spot welding time	S	0.1 ~ 10
	Arc ignition methods	-	HF and lift arc start
Duty cycle	MMA	%	210 @ 50
	TIG		300 @ 20
Efficiency		%	86
Idle State Power		W	< 50
Housing protection grade		IP	23S
Power factor		cosφ	0.84
Insulation grade		-	F
Standard			IEC60974-1
Noise		Db	<70
Humidity		%	≤90 (no condensation of water drops)
Temperature Range	Storage temperature	°C	-10° ~ 40°
	Operating temperature	°C	-25° ~ 55°
Size	Power source only	mm	566 x 224 x 405
	Water cooled package		940 x 420 x 1130
Weight	Power source only	Kg	19.4
	Water cooled package		74
Remote control option			Yes

Please Note

Due to variations in manufactured products all claimed performance ratings, capacities, measurements, dimensions and weights quoted are approximate only. Achievable performance and ratings when in use can depend upon correct installation, applications and use along with regular maintenance and service.

CONTROLS

Front view Jasic TIG 300P

1. Digital Control Panel: See page 12 for in depth explanation of the controls
2. "+" Output terminal: To connect the work clamp in TIG mode or the electrode holder in MMA mode
3. "-" Output terminal: To connect the TIG torch or work clamp in MMA mode
4. 9 pin remote connection: See page 29 for further details
5. Gas Outlet: used to connect the gas fitting/hose of the TIG torch

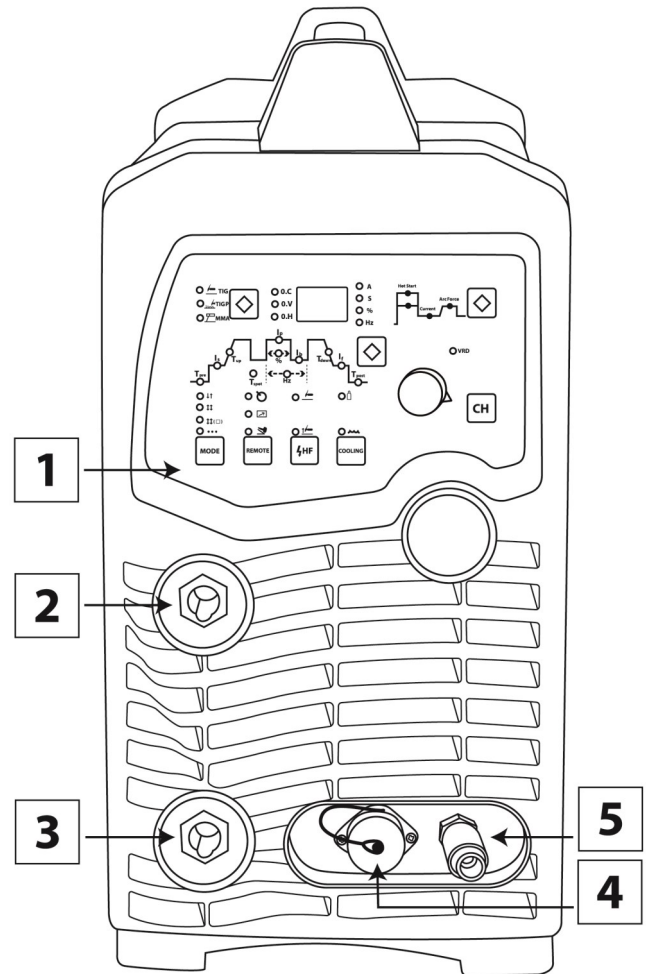

Rear view Jasic TIG 300P

6. Water cooler supply outlet: The optional cooler plug will connect to this socket
7. Gas Inlet: The gas supply hose connect to this inlet
8. Mains input supply cable
9. Control Fuse: This fuse is for water cooler output and is rated at 5amps
10. Mains input ON/OFF power switch

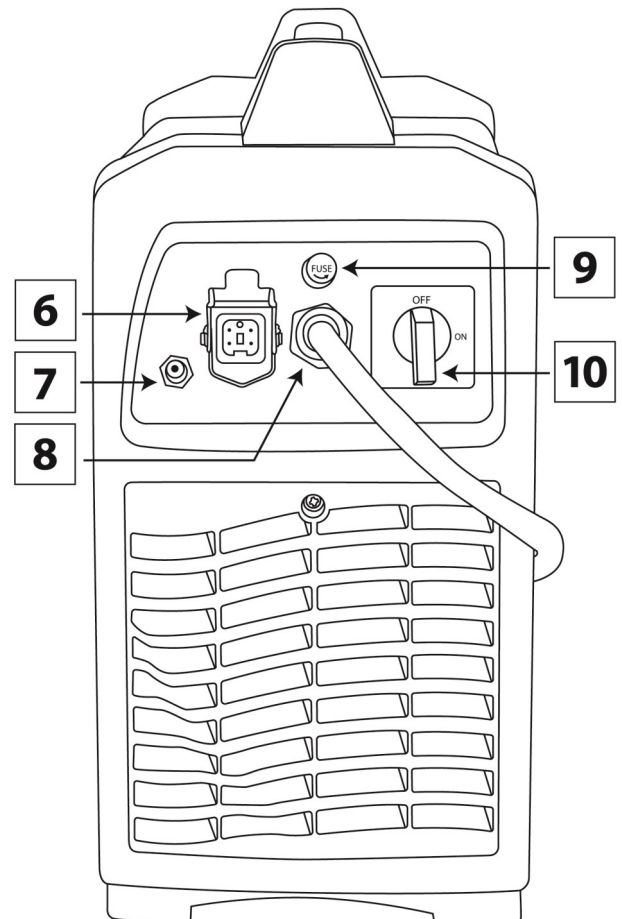

CONTROLS

Control panel view Jasic TIG 300P

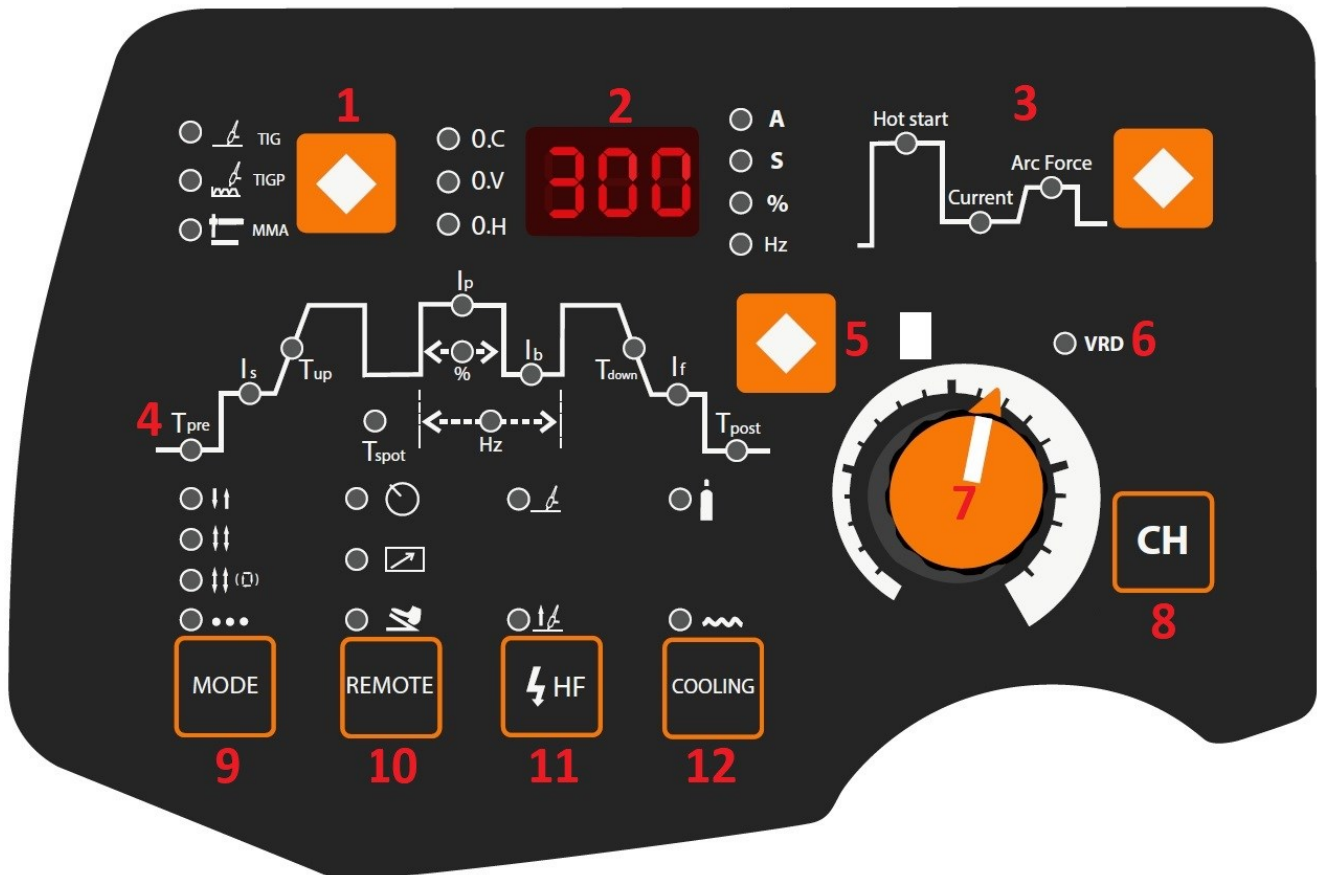

1. Welding mode selection zone: Welding mode selection zone contains welding mode indicators and selection key. Welding modes include DC TIG, Pulse TIG, DC MMA. Press the welding mode selection key to choose the according welding mode. The welding mode selected will be indicated by the corresponding LED being lit and there is welding current flowing
2. Digital meter: Displays pre-set and actual current before and during welding. Also used to display parameter adjustment settings along with any error codes
3. MMA parameter selection zone: By pressing the switch you will have access to adjust hot start, current and arc force in MMA mode
4. Parameter selection area: Pushing the selection switch (5) will highlight the LED of the parameter to be adjusted in the selection area
5. Parameter selection button: Press to select the required welding parameter to be adjusted
6. VRD (voltage reduction device) indicator
7. Adjustment control dial: Rotating this dial will adjust selected parameter shown in the digital display
8. CH is the weld parameter recall/storage channel selector
9. TIG torch switch mode selection area
10. Remote control selection: Pressing this key will set current control from the panel or a remote device such as a foot pedal or TIG torch remote potentiometer
11. TIG starting mode selection area (contact or non contact ignition): When you press this switch, you either select HF arc ignition or lift arc TIG mode and the matching indicator will illuminate
12. Cooling selector switch (water or air): Using this switch will turn on/off the fitted TIG water cooler and the matching indicator will illuminate

FUNCTIONS

Welding mode selection switch

The welding mode selection zone contains the welding mode indicators along with the mode selection switch for TIG DC, TIG Pulse and MMA welding modes. Press the welding mode selection key to choose the according welding mode. The welding mode being selected LED will be lit when selected and there is welding current flowing.

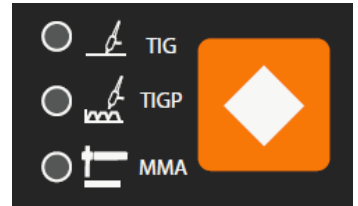

MMA parameters selection zone

This area contains the MMA parameters selection.

1. Ensure you are in MMA mode (as described above).
2. By pressing the  key you will circulate through hot start, current and arc force functions.

These functions are not available during TIG and TIGP modes.

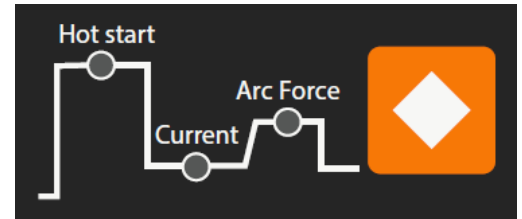

The display and parameter area

This area contains the display meter, unit parameters indicators and the warning indicator.

1. The window in the middle is a display to show all user parameters
2. O.C on the left is the over current protection LED
3. O.V on the left is the over voltage protection LED
4. O.H on the left is the over heat protection LED
5. The A LED on the right is current
6. The S LED on the right is time in seconds
7. The % LED on the right is percentage
8. The Hz LED on the right is frequency respectively
9. Error codes will also be shown on this display



Selector switch

This button is used to navigate around the control panel.



VRD Indicator

The VRD LED will be lit when the machine is in MMA mode and the VRD function is enabled.

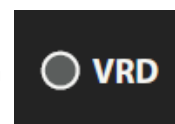

Parameter adjustment rotary knob

Parameter adjustment rotary knob is for adjusting all welding parameter available to the user.



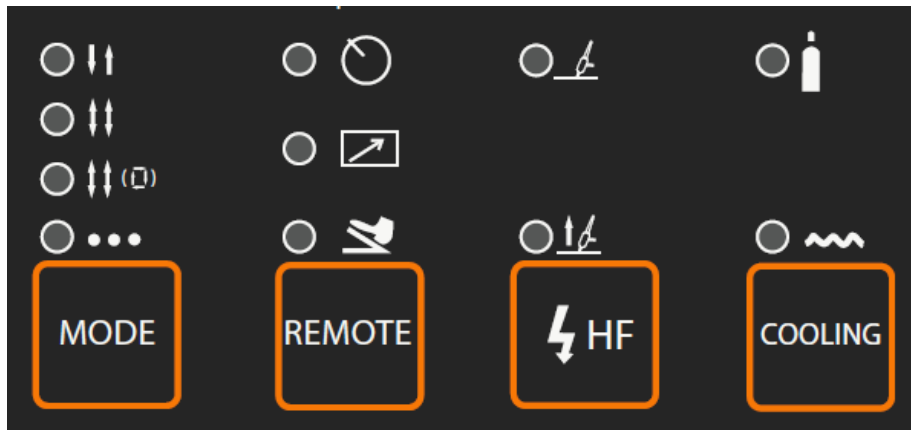

FUNCTIONS

TIG options selection zone



This TIG options zone includes 4 parts:

TIG torch trigger mode selection, TIG torch trigger remote control options, HF arc ignition switch for either HF ignition or lift TIG arc starting and a water cooling mode switch which are described in a little more details as below:

1. Trigger function modes: 2T, 4T, repeat and spot. Press the 'mode' key to select the required welding trigger mode and depending on your selected TIG torch trigger option the corresponding LED indicator will illuminate, See page 27 For further details.
2. Remote control mode: Pressing the 'remote' key will allow you to set current control from the control panel, remote device TIG torch remote potentiometer or a foot pedal, depending on your selected remote option the corresponding LED indicator will illuminate
3. TIG Arc ignition type.
 - (a) Press the 'HF' key and when the HF (top) indicator is ON, you have engaged HF arc ignition.
 - (b) Press the 'HF' key again and when the lift arc (bottom) indicator is On, you have entered lift arc ignition. When in this mode you place the torch to contact work piece, pull torch trigger then lift the torch slowly to achieve arc ignition.
4. Water cooling switch (TIG mode only for the JT-300P air/water cooled package).
By pressing the 'cooling' key, you will select the following cooling modes:
 - (a)  When this indicator is lit it shows the machine is in air cooling mode. The cooler will not start and if a water cooled torch is used then this will likely fail.
 - (b)  When this indicator is lit it shows the machine is in water cooling mode. When a welding arc is established the cooler unit will start and stop automatically after welding is complete. When the cooler runs and no welding is carried out it will automatically turn of after 15 minutes.

When using a water cooled TIG torch the water cooling system will monitor the water flow and if for some reason the cooling tank is empty or flow stops or there is a flow restriction then E-71 warning will show on the control panel digital display and the machines welding output will stop. The user should then check the cooling system.

FUNCTIONS

TIG parameters selection zone

Press  to circulate clockwise and select the required TIG parameter.

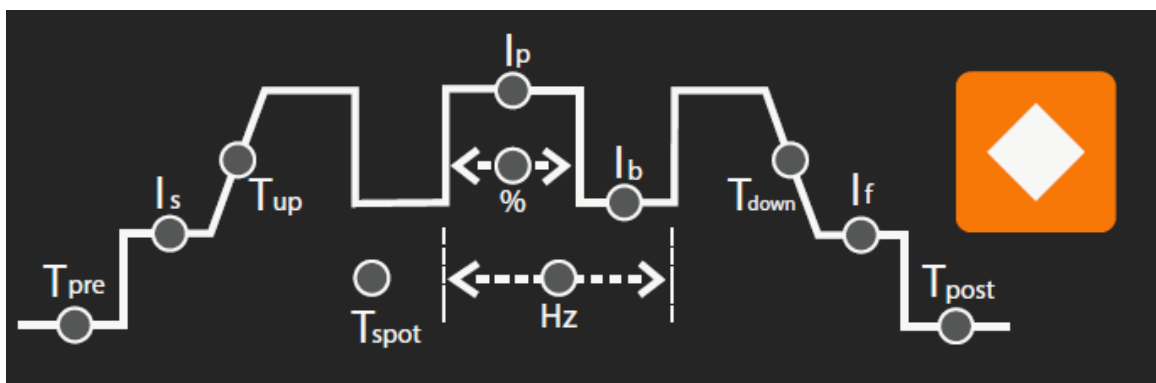

Tpre - Pre flow time

Ib - Base current

Hz - Pulse frequency

Is - Initial Current

Tdown - Downslope time

% - Pulse duty cycle

Tup - Upslope

If - Final current

Tspot - Spot welding time

Ip - Peak current

Tpost - Post flow time

Please note: Ib, Hz and % is only available when TIG pulse (TIGP) welding mode is selected
Tspot is only available when in spot (•••) trigger mode is selected

Channel key

 The TIG 300P is equipped with 8 welding parameters storage channels for DC TIG, Pulse TIG and DC MMA.

When the TIG 300P is turned on, it will be working in a certain stored channel which will be the channel previously used prior to being turned off.

To check the channel number, press the channel key  while the machine is in standby mode and the display window will show the current channel number, for example, when the current working channel is number 6, then the digital display will show CH-6.

To change the channel number, simply press the channel key when machine is in standby mode and the display window will show the current channel number, to change this use the rotary adjustment knob to change the working channel number from CH-1 to CH-8.

To exit channel management just press the CH key again.

Storing channel (weld) parameters is done by first choosing the required channel number you wish to save too, then adjust the required user welding parameters, the operator then has to start the welding process to automatically save the current welding parameters.

See page 25 for listing your stored welding program/channels.

PLEASE NOTE:

If the operator does not strike an arc after making weld parameter adjustments on a selected channel number, the system will not save the current parameters which means, if the machine is turned off then turned back on, it will automatically revert back to the previous channel number and welding parameters.

To load stored channel parameters, press the channel key when the machine is under standby mode, the digital display will show the current working channel. To access to required stores channel rotate the control dial to change the channel numbers from CH-1 to CH-8.

Re-press the CH key after selecting the required channel number and the system will now show all the parameters under this channel for operator's usage.

FUNCTIONS

Water cooler (water cooled package only)

The TIG 300P can come complete as a water cooled package which is supplied with a TIG torch water cooler which mounts on a trolley with the Jasic inverter power source mounted above.

The water cooler front panel includes a work indicator, control ON/OFF switch and quick connectors for the water output (blue) and water input (red) which allow connection to the TIG torch.

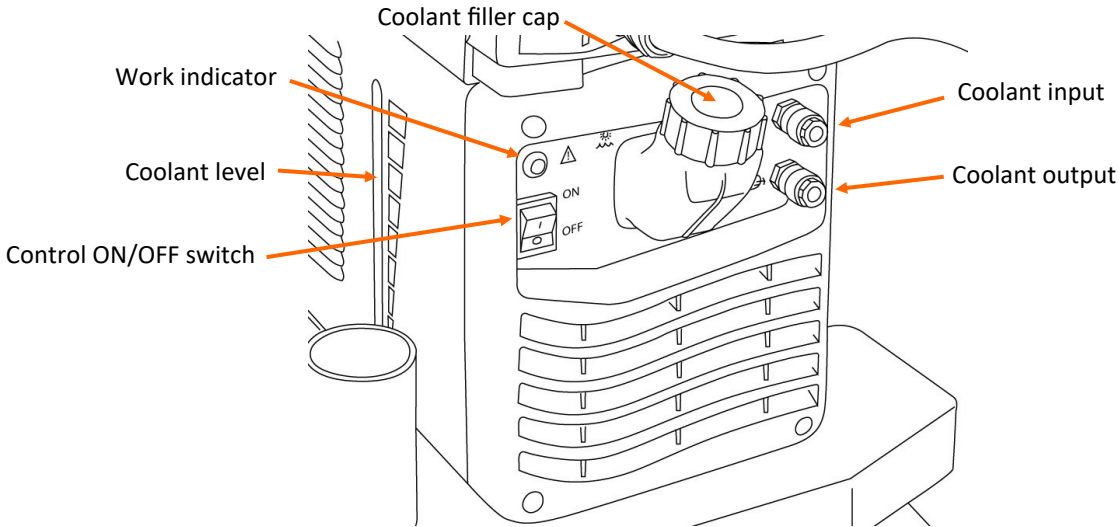

1. The work indicator is a visual means of letting the user know if the water cooler is turned ON or not.
 - If the work indicator is ON, then the water cooler is pumping coolant around the TIG torch
 - If the work indicator is OFF, then it means the water cooler is not functioning.
2. The water cooler operation status is controlled by the Jasic power source. When the machine power source is under TIG water cooling, which is to say, the indicator is ON, the options are:
 - When there is current output from the power source the water cooler work indicator is on.
 - When there is no current output, the water cooler will stop working after 15 minutes and the work indicator will be off.
3. The cooler control fuse is located on the rear panel of the power source and is fuse rated of 5A.
4. Output (supply): This quick connector socket has a blue base and is used to connect to the water supply hose of the TIG torch quick connect plug (the TIG torch's blue quick connector or it may be labelled water supply hose).
5. Input (return): This quick connector socket has a red base and is used to connect the return water cooling hose of the TIG torch, this may be an extension of the power cable hose of the torch as this hose carries the returning 'hot' water from the torch via a dinse adaptor connected to the '-' dinse socket. See page 17 for connection layout.
6. The cooler output socket is located on the rear panel of the power source and the socket pins are as follows:

Pin1 and Pin2 are the 230V AC output terminals of the water tank.
 Pin3 and Pin4 are the error signal input terminals of the water cooler.

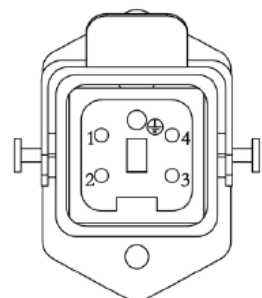

INSTALLATION

Unpacking

Check the packaging for any signs of damage.

Carefully remove the machine and retain the packaging until the installation is complete.

Location

The machine should be located in a suitable position and environment. Care should be taken to avoid moisture, dust, steam, oil or corrosive gases.

Place on a secure level surface and ensure that there is adequate clearance around the machine to ensure natural airflow.

Input connection

Before connecting the machine you should ensure that the correct supply is available.

Details of the machine requirements can be found on the data plate of the machine or in the technical parameters shown in the manual.

The equipment should be connected by a suitably qualified competent person. Always ensure the equipment has a proper grounding.

Never connect the machine to the mains supply with the panels removed.

Output connections

Electrode polarity

In general when using manual arc welding electrodes the electrode holder is connected to the positive terminal and the work return to the negative terminal.

"+" output terminal: For MMA connect the electrode holder

"-" output terminal: For MMA connect the work return lead

Always consult the electrode manufacturer's data sheet if you have any doubts.

When using the machine for TIG welding the TIG torch should be connected to the negative terminal and the work return to the positive terminal.

"+" output terminal: For TIG connect the work return lead

"-" output terminal: For TIG connect the TIG torch

Gas connections

Connect the gas hose to the regulator/flowmeter located on the shield gas cylinder and connect the other end to the machine.

Please Note:

Check these power connections daily to ensure they have not become loose otherwise arcing may occur when used under load.

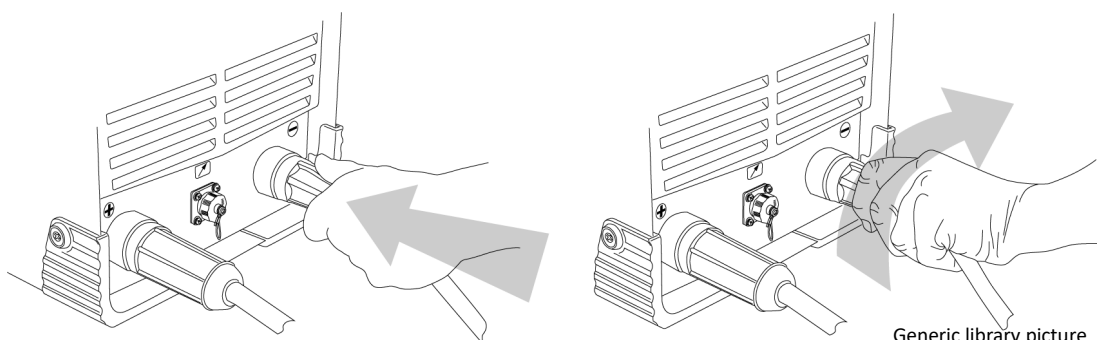

INSTALLATION

MMA welding

Insert the cable plug with electrode holder into the “+” socket on the front panel of the welding machine and tighten it clockwise.

Insert the cable plug of the work return lead into the “-” socket on the front panel of the welding machine and tighten it clockwise. Example shown below:

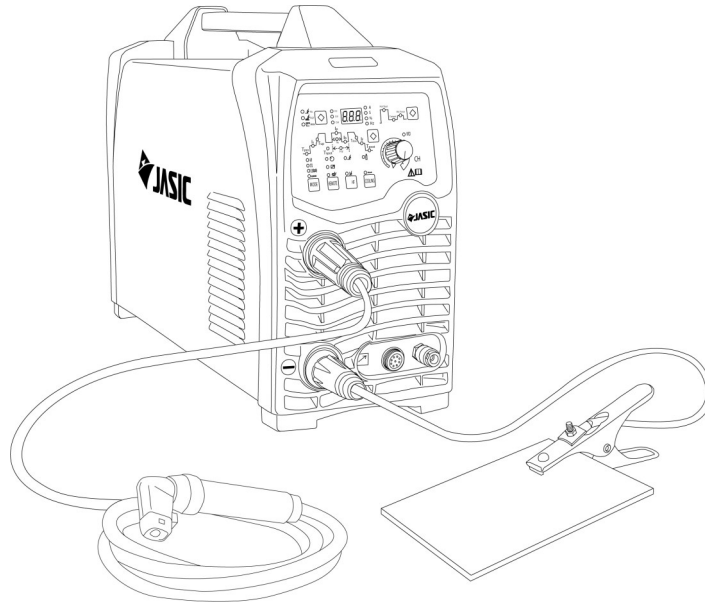

TIG welding

Insert the cable plug with the work clamp into the “+” socket on the front panel of the welding machine and tighten it clockwise.

Insert the cables plug of the TIG torch into the “-” socket on the front panel of the machine and tighten clockwise. Connect the gas quick connector into the outlet on the machine front.

Connect the torch switch plug into the socket on the front panel.

Connect the gas hose to the regulator/flowmeter located on the shield gas cylinder and connect the other end to the machine. Example shown below:

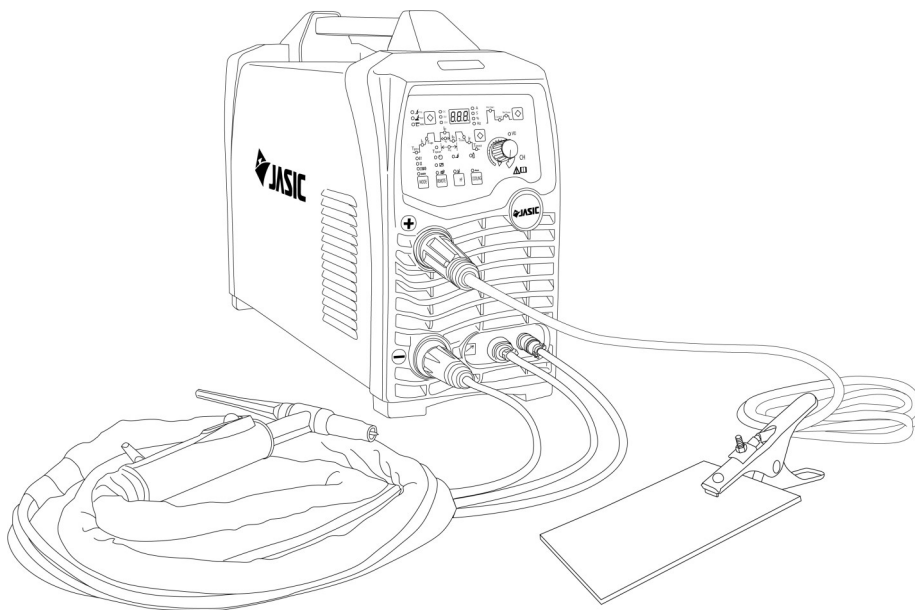

Please Note:

Before starting any welding activity ensure that you have suitable eye protection, protective clothing and all required PPE. Also take the necessary steps to protect any persons within the area.

INSTALLATION

WATER COOLED TIG TROLLEY PACKAGE COMPATABILITY

These assembly instructions are suitable for the following Jasic TIG welding packages:

JT-202A-WC

JT-202D-WC

JT-300P-WC

JT-315MWD-WC

CONTENTS

Check the trolley packaging for any signs of damage.

Carefully remove all the components, check that all parts are present and retain the packaging until the assembly is complete.

Kit Contents:

1 x Base Unit (assembled)

2 x Cylinder Chain/Straps

2 x Side fixing brackets

1 x Upright Cylinder Support

2 x Top Shelf Brackets

1 x Top unit (with handle)

6 x M5 Screws

10 x M10 Screws

12 x M6 Screws

Please Note: This kit is used for other machine packages, you may note that extra screws are supplied and as a result there may be some screws left over once you have fully assembled the trolley package.

For the following instructions we have used the Jasic JT-315 ACDC Multi Wave TIG power source and cooler as shown below.



INSTALLATION

WATER COOLED TIG TROLLEY PACKAGE CONTENTS

The below shows the main contents of the TIG trolley assembly kit.

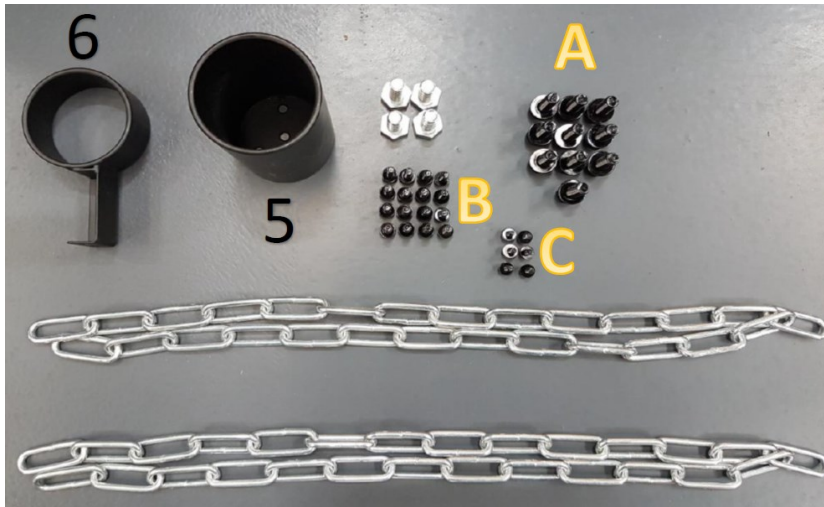

Various sundry items (required for assembly)

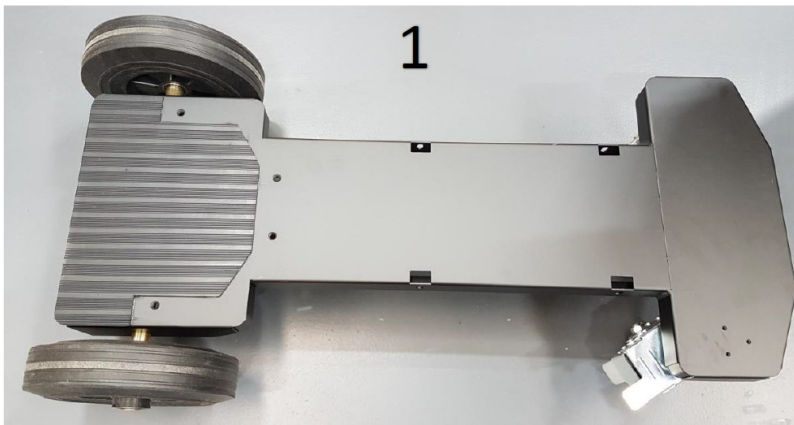

Base unit (item 1) including assembled wheels

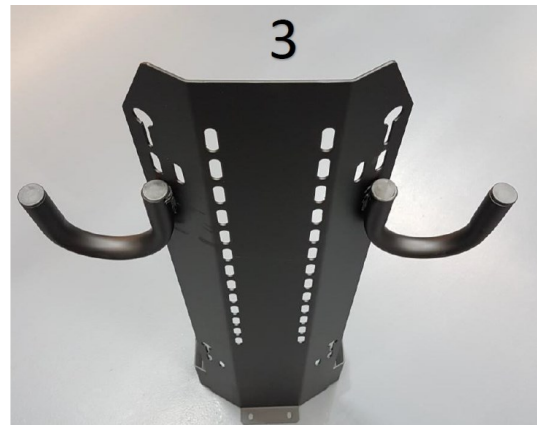

Upright Cylinder Support (item 3)

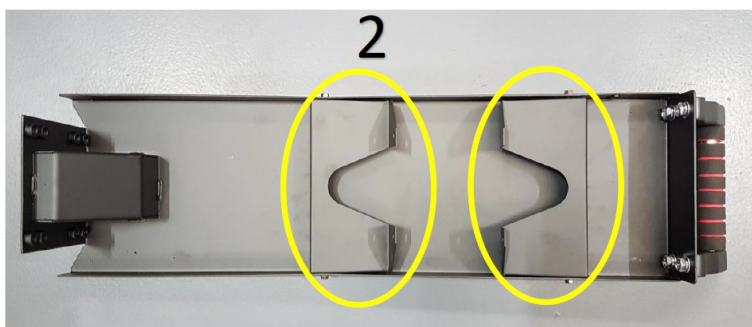

Top shelf (item 2) also showing circled top shelf brackets



Side fixing brackets (item 4)

INSTALLATION

WATER COOLED TIG TROLLEY PACKAGE ASSEMBLY

- 1 Place the base unit on a flat surface, locate the cylinder support (Item 3) and use M10 screws (A) to fix the cylinder support to the base unit (item1).
- 2 Locate the cooler base brackets (circled yellow) which secures the water cooler to the base unit. (brackets supplied with cooler)



- 3 Place the cooler on its side and mount the two brackets supplied with the water cooler (circled yellow) to the bottom of the cooler as shown using the screws (B) supplied with the cooler. Please Note: Fit the front bracket to the holes that are more central on the bottom of the cooler.

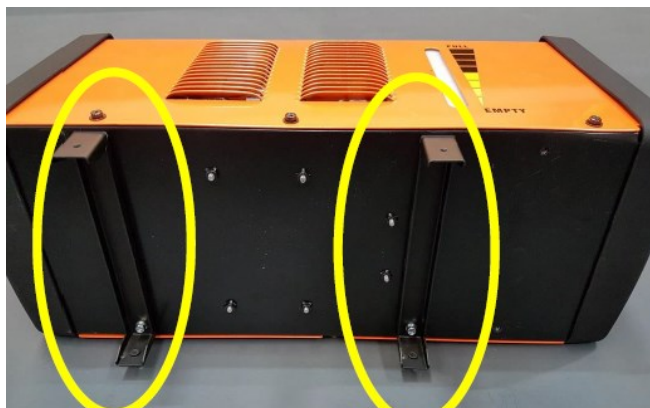

- 4 Mount and fix the water cooler to the base unit (item 1) using the supplied qty 4 screws (B).



INSTALLATION

WATER COOLED TIG TROLLEY PACKAGE ASSEMBLY

- 5 Fit the two side brackets (item 4) to the water cooler as shown below.



- 6 Fit the TIG wire 'cup' (item 5) to the base using the supplied 3 screws (C)



- 7 Remove the bottom side front and rear screws either side of the power source (the middle screw may not be required to be removed) and mount the power source on top of the water cooler lining up the holes of the bracket. (The bracket should be on the outside of the power source panel). Secure the power source with the screws that were removed.



INSTALLATION

WATER COOLED TIG TROLLEY PACKAGE ASSEMBLY

- 8 Remove the top brackets shown with item 2 and fit to the top of the power source as shown below. Use the screws you have removed from the power source lid to fix the two brackets in place.



- 9 Mount the top shelf (item 2) on top of the fitted brackets and use the screws removed earlier to fix the top shelf in place. Also secure the top shelf (item 2) to the cylinder upright (item 3) with screws (A).



10. Fix (item 6) which assists holding the TIG wire in place, to the top panel (item 2) as shown below using two screws ©, a 7mm spanner may be required to assist with fastening this accessory in place.

11. Fit the supplied bottle chains (as shown below) through the relevant slots on item 3 and the assembly is now complete.



12. Connect the water cooler power plug to the control socket on the rear panel of the TIG power source.
13. Check the relevant TIG machine operating manual for instructions for fitting a water cooled TIG torch.

OPERATION - MMA



Before starting any welding activity ensure that you have suitable eye protection and protective clothing. Also take the necessary steps to protect any persons within the welding area.

MMA welding mode

MMA (Manual Metal Arc), SMAW (Shielded Metal Arc Welding) or just Stick Welding.

Stick welding is an arc welding process which melts and joins metals by heating them with an arc between a covered metal electrode and the work.

Shielding is obtained from the electrode outer coating, often called flux. Filler metal is primarily obtained from the electrode core.

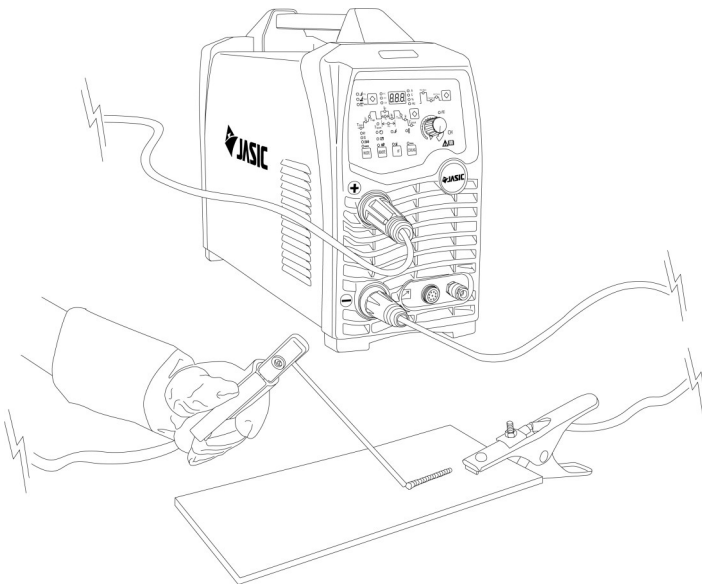
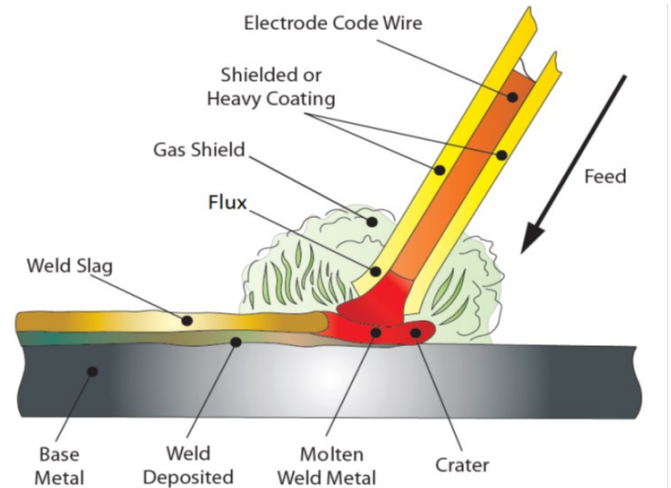

The electrodes outer coating called flux assists in creating the arc and provides a shielding gas on cooling forms a slag covering to protect the weld from contamination.

When the electrode is moved along the work piece at the correct speed the metal core deposits a uniform layer called the weld bead.

MMA operation steps

After connecting the welding leads as detailed you will need to switch the power switch on the back panel of the machine to "ON".

Select MMA mode by pressing the welding mode selecting key until the MMA LED illuminates and MMA can be carried out.

There is now welding voltage output at both output terminals.

Please Note:

 The VRD indicator is now ON to inform you that the output voltage is set to <math><12V</math> DC.

The digital display meter will now be showing a pre-set welding current and rotating the control dial will increase or decrease the value.

The TIG300P also features hot start and arc force to ensure that you obtain the best MMA welding results according to your welding application, please see the following page which describes these welding parameters.

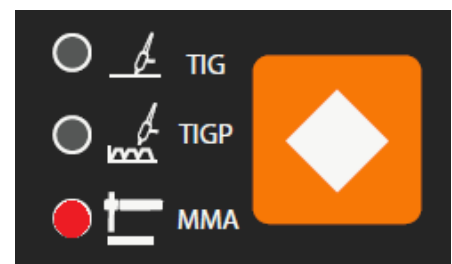

OPERATION - MMA



Before starting any welding activity ensure that you have suitable eye protection and protective clothing. Also take the necessary steps to protect any persons within the welding area.

MMA operation steps

MMA welding current

Select the welding current setting function by pressing the MMA welding parameter selecting key and welding current in MMA can be set. The current parameter range is 20~210 amps and is adjusted via the adjustment knob and the pre-set amperage is indicated on the front panel digital display.

The Welding current setting can be carried out during welding.

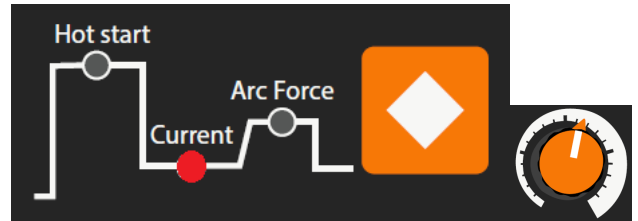

MMA hot start

Select the hot start setting function by pressing the welding parameter selection key until the hot start LED illuminates. The hot start parameter range is 0~60amps and is adjusted via the adjustment knob and the hot start additional amperage is indicated on the front panel digital display.

The Hot start amperage setting can be carried out during welding.

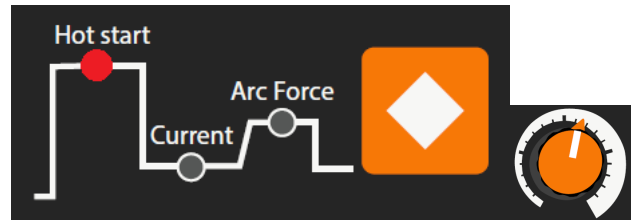

MMA arc force

Select the arc force setting function by pressing the welding parameter selection key until the arc force LED illuminates. The arc force parameter range is 0~60amps and is adjusted via the adjustment knob and the arc force additional amperage is indicated on the front panel digital display.

The arc force amperage setting can be carried out during welding.

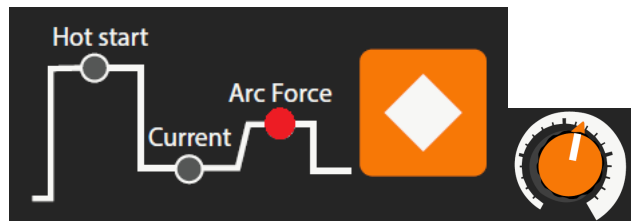

If the secondary cables (welding cable and earth cable) are long, select cable with larger cross-section to reduce the voltage drop.

Please ensure to check that you have the electrode polarity correct to your chosen electrode and that you set the pre-set output amperage correctly for the electrode being used.

MMA welding electrodes vary depending on material, work piece thickness, welding position and joint form.

Pre-set the welding current according to the type and size of the electrode, clip the electrode and then welding can be carried out by short circuit arc ignition. For welding parameters, please refer to the opposite table.

Electrode Diameter (mm)	Recommended Welding Current (A)	Recommended Welding Voltage (V)
1.0	20 ~ 60	20.8 ~ 22.4
1.6	44 ~ 84	21.76 ~ 23.46
2.0	60 ~ 100	22.4 ~ 24
2.5	80 ~ 120	23.2 ~ 24.8
3.2	108 ~ 148	24.32 ~ 24.92
4.0	140 ~ 180	24.6 ~ 27.2

OPERATION - TIG



Before starting any welding activity ensure that you have suitable eye protection and protective clothing. Also take the necessary steps to protect any persons within the welding area.

TIG welding mode

Terms used: TIG – Tungsten Inert Gas, GTAW – Gas Tungsten Arc Welding.

TIG welding is an arc welding process that uses a non-consumable tungsten electrode to produce the heat for welding.

The weld area is protected from atmospheric contamination by a shielding gas (usually an inert gas such as argon or helium) and a filler rod matching the base material is normally used, though some welds, known as autogenous welds, are carried out without the need for filler wire.

TIG process can be either DC or AC modes:

DC - Direct current for welding steel, stainless steel, copper etc.

AC - Alternating current for welding aluminium and it's alloys.

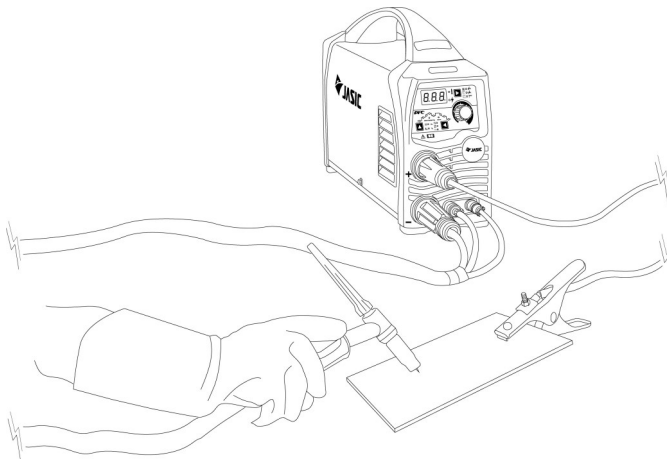
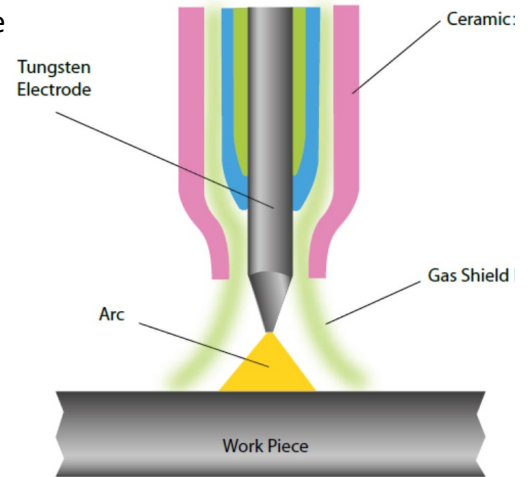

Connect the TIG torch connector to the “-” quick socket on the machine panel and tighten it clockwise.

Connect the switch plug on the TIG torch to the corresponding socket on the machine panel, this is a quick connector so it is not necessary to turn the plug.

Insert the quick plug on the work return cable into the “+” quick socket on the machine panel and tighten it clockwise. Clamp the work clamp to the work piece.

Connect the gas hose of the TIG torch to the quick connector on the machine front.

Connect the gas hose to the gas inlet on the back panel of the machine. The other end of the supply hose connects to the gas regulator on the cylinder.

Press the torch trigger briefly, the solenoid valve will operate and gas will flow.

Adjust the welding current according to the thickness of the work piece to be welded (for a guide to welding parameters, please refer to the table below).

Hold the torch 2-4mm away from the work piece and then press the torch trigger.

After arc is ignited, the HF discharge will cease, the current will maintain the pre-set value and welding can be carried out.

After releasing the torch trigger, the welding arc stops but gas continues flowing for the post flow time and welding ends.

The amperage guide for TIG welding tungsten sizes can vary depending on material, work piece thickness, welding position and joint form.

Tungsten Size	DC – Electrode Negative
1.0mm	15 – 80A
1.6mm	70 – 150A
2.4mm	150 – 250A
3.2mm	250A – 400A
4.0mm	400A – 500A
6.0mm	750A – 1000A

OPERATION - TIG



Before starting any welding activity ensure that you have suitable eye protection and protective clothing. Also take the necessary steps to protect any persons within the welding area.

TIG operation steps

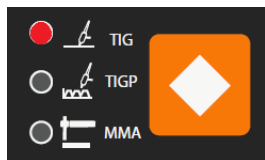

Select the DC TIG mode by pressing the welding mode selecting key.



Select the 2T mode by pressing the operation mode selecting key.

Select the pre flow time setting function by pressing the parameter selecting key until the T pre LED illuminates. The pre flow time range is 0~15 seconds and is adjusted via the control knob and the pre flow time is shown on the front panel digital display.

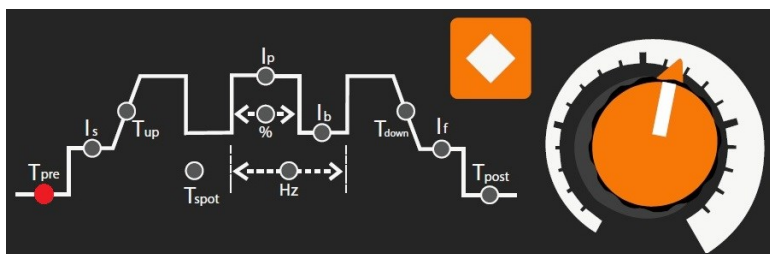

Select the initial current setting function by pressing the parameter selection key until the I_s LED illuminates. The initial current range is 0~60amps and is adjusted via the control knob and the amperage is shown on the front panel digital display. The initial current amperage can be adjusted during welding.

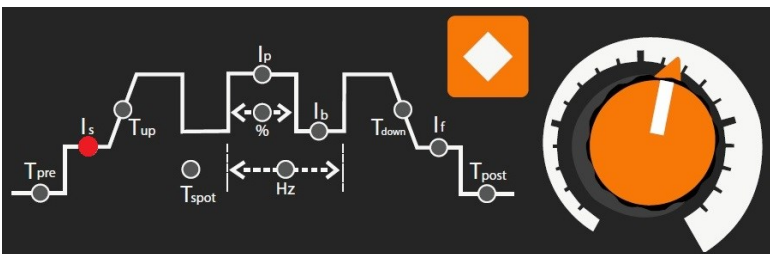

Select the upslope time setting function by pressing the parameter selection key until the T_{up} LED illuminates. The upslope time range is 0~10 seconds and is adjusted via the control knob and the time is shown on the front panel digital display.

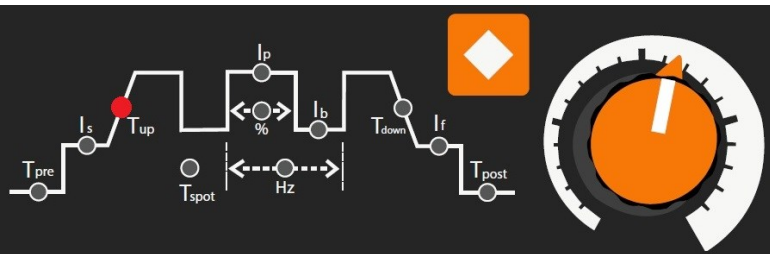

Select the peak current setting function by pressing the parameter selection key until the I_p LED illuminates. The peak current range is 5~300amps and is adjusted via the control knob and the amperage is shown on the front panel digital display. The peak current amperage can be adjusted during welding.

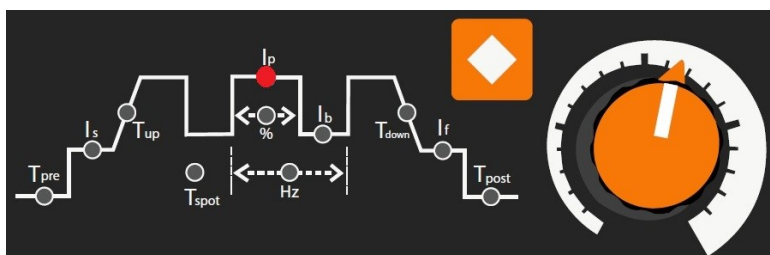

OPERATION - TIG



Before starting any welding activity ensure that you have suitable eye protection and protective clothing. Also take the necessary steps to protect any persons within the welding area.

TIG operation steps

Select the downslope time setting function by pressing the parameter selection key until the Tdown LED illuminates. The downslope time range is 0~10 seconds and is adjusted via the control knob and the time is shown on the front panel digital display.

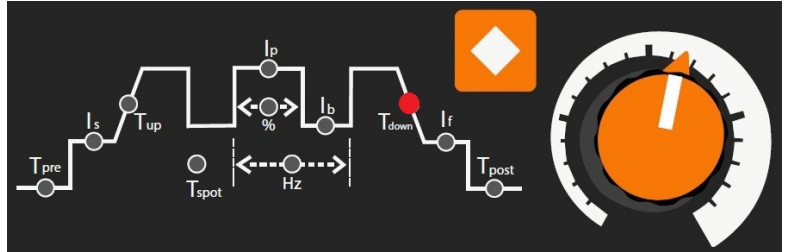

Select the final current setting function by pressing the parameter selection key until the If LED illuminates. The final current range is 0~60amps and is adjusted via the control knob and the amperage is shown on the front panel digital display. The final current amperage can be adjusted during welding.

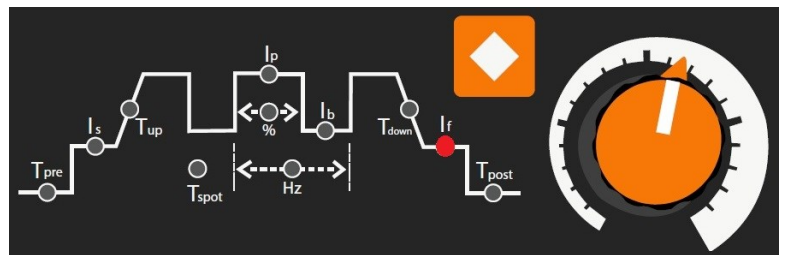

Select the post flow time setting function by pressing the parameter selecting key until the Tpost LED illuminates. The post flow time range is 0.5~15 seconds and is adjusted via the control knob and the post flow time is shown on the front panel digital display.

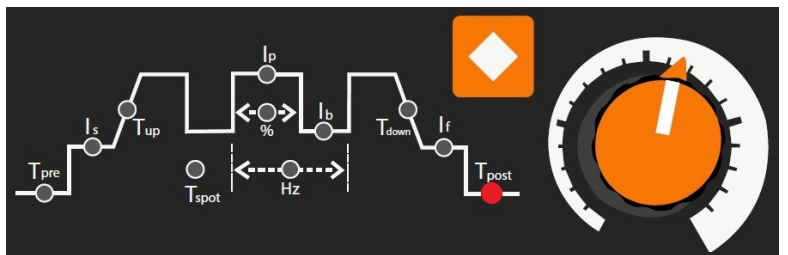

After the parameters are set appropriately, open the gas valve of the cylinder and adjust the gas regulator to the desired flow value.

Keep the torch 2-4mm away from the work piece and then press the torch trigger, the solenoid valve will operate, gas will flow and HF starts.

After arc is ignited, the HF discharge rustling disappears, the current rises up to the pre-set value and welding can be carried out. After releasing the torch trigger, the current begins to decrease automatically to the crater current value. Then, arc stops with gas kept flowing for the post flow time and welding ends.

Pulsed TIG

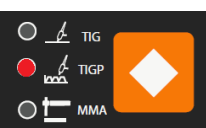

Select the pulsed TIG mode by pressing the welding mode selecting key.



Select the 2T mode by pressing the operation mode selecting key.

Proceed with the set up as for standard TIG. The welding current setting now becomes the peak welding current of the pulse. The next step will allow setting of the base current. This is only allowed when the pulse mode is selected.

OPERATION - TIG



Before starting any welding activity ensure that you have suitable eye protection and protective clothing. Also take the necessary steps to protect any persons within the welding area.

TIG operation steps

Pulsed TIG - Continued

Select the peak current setting function by pressing the parameter selection key until the I_p LED illuminates. The peak current range is 5~300amps and is adjusted via the control knob and the amperage is shown on the front panel digital display. The peak current amperage can be adjusted during welding.

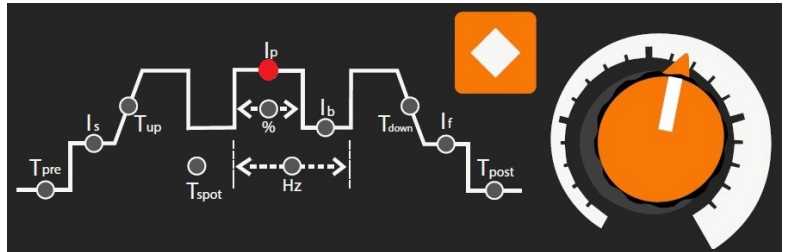

Select the base current setting function by pressing the parameter selection key until the I_b LED illuminates. The base current range is 5~300amps and is adjusted via the control knob and the amperage is shown on the front panel digital display. The base current amperage can be adjusted during welding.

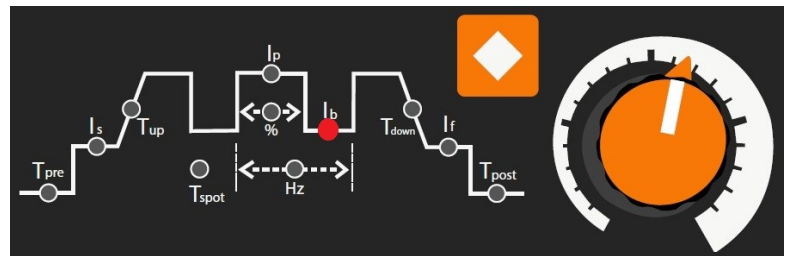

Select the downslope time, crater current and post flow gas time as standard TIG.

Select the pulse duty cycle setting function by pressing the parameter selection key until the % LED illuminates. The pulse duty range is 10~90% and is adjusted via the control knob and the percentage is shown on the front panel digital display. The pulse duty cycle can be adjusted during welding.

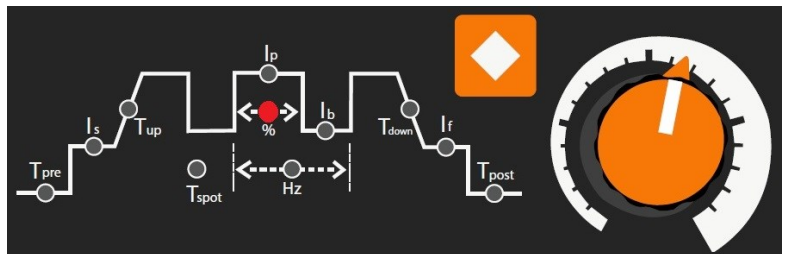

Select the pulse frequency setting function by pressing the parameter selection key until the Hz LED illuminates. The pulse frequency range is 0.5~500Hz and is adjusted via the control knob and the frequency is shown on the front panel digital display. The frequency can be adjusted during welding.

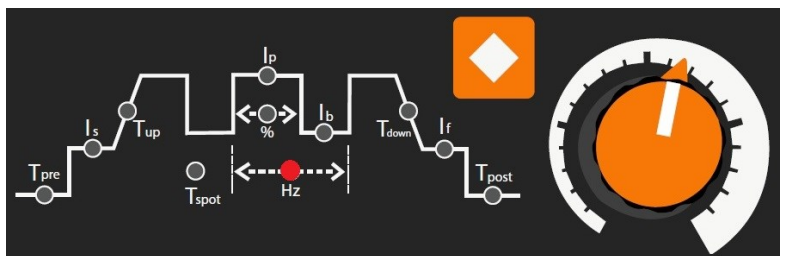

Select the spot time setting function by pressing the parameter selection key until the T_{spot} LED illuminates. The spot time range is 0.1~10 seconds and is adjusted via the control knob and the time is shown on the front panel digital display.

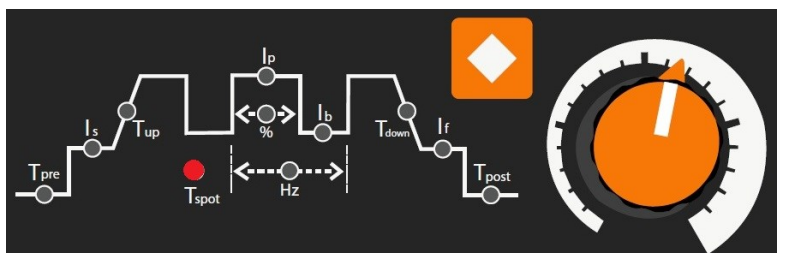

OPERATION - TIG



Before starting any welding activity ensure that you have suitable eye protection and protective clothing. Also take the necessary steps to protect any persons within the welding area.

TIG operation steps

After the parameters are set appropriately, you can then open the gas valve of the cylinder, and adjust the gas regulator to the desired gas flow.

Keep the torch 2-4mm away from the work piece and then press the torch trigger.

Gas will flow followed by the HF and the arc is ignited.

Once the arc is ignited the HF will cease and the current rises up to the preset value and welding can be carried out.

After releasing the torch trigger, the current begins to decrease automatically to the crater current value. Then, the arc stops with the gas continuing to flow for the post flow time and welding ends.

Parameter autosaving

The parameters having been adjusted will be autosaved in the parameter group currently used.

Please Note: no autosaving will be done in the case that no welding is done after parameters are adjusted and the machine was turned off in 5 seconds time.

When the machine is next turned on, the parameters in this parameter group are just the parameters used last time.

When the welding mode and operation mode are reselected, autosaving will be done in 10 seconds.

See page 15 for manual storing and recalling saving procedures which are available for this machine via the channel key.

Memory Storage

Use the below section to list your stored program channel numbers that you have created and stored for specific welding tasks.

Channel Memory	Job number or Description of welding job
CH1	
CH2	
CH3	
CH4	
CH5	
CH6	
CH7	
CH8	

OPERATION - TIG



Before starting any welding activity ensure that you have suitable eye protection and protective clothing. Also take the necessary steps to protect any persons within the welding area.

TIG operation steps

HF and Lift TIG mode

The TIG 300P features HF arc ignition which is available in TIG 2T, 4T, Cycle and Spot modes.

The 300P is also equipped with lift arc ignition, which is another form of arc starting the welding arc by allowing the tungsten to touch (short circuits) to the work piece with current being kept at a small level and then lifting the tungsten off the work piece to create arc ignition.

The biggest advantage of this arc starting method is to avoid HF interference and lower work piece's tungsten pollution, but when compared with HF arc ignition it offers a lower successful rate. If unnecessary, please take HF arc ignition as your first choice.

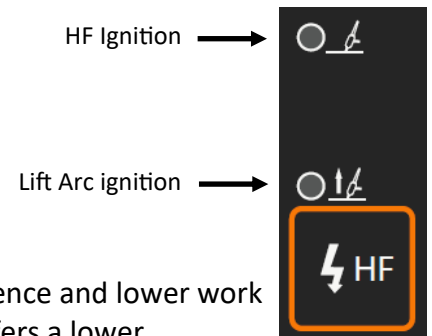

Arc ignition type selection.

- ⇒ Press the HF switch until the HF ignition LED indicator is ON to enter TIG HF TIG arc ignition function.
- ⇒ Press the HF switch until the Lift arc ignition LED indicator is ON to enter lift TIG arc ignition function.

When in HF TIG mode (2T)

Keep the torch tungsten 2-4mm away from the work piece and then press and hold the torch trigger. Gas will flow followed by the high frequency (HF) and the arc is ignited. Once the arc is ignited the HF will cease and the current rises up to the preset values set by the user and welding is then carried out. After releasing the torch trigger, the current begins to decrease automatically to the final (crater) current value. The welding arc will then stop with gas still flowing until the gas post flow time ends and welding is finished.

When in lift TIG mode (2T)

In this mode, place the torch tungsten in contact with the work piece and then press and hold the torch trigger. Gas will flow and then you can lift the tungsten slowly away from the work piece to initiate the welding arc and the current rises up to the preset values set by the user and welding is then carried out. After releasing the torch trigger, the current begins to decrease automatically to the final (crater) current value. The welding arc will then stop with gas still flowing until the gas post flow time ends and welding is finished.

OPERATION - TIG



Before starting any welding activity ensure that you have suitable eye protection and protective clothing. Also take the necessary steps to protect any persons within the welding area.

TIG torch trigger operation steps

- Indicator for 2T →
- Indicator for 4T →
- Cycle mode →
- Indicator for spot →



2T mode (normal trigger control)

The 2T (↑↓) LED light will illuminate when the power source is in 2T welding mode. In this mode, the torch trigger must remain pressed (closed) for the welding output to be active. See example below:

Press and hold the torch trigger to activate the power source, the gas valve and gas will flow.

After the gas pre flow time ends, HF discharge begins and then the welding arc will ignite and then the current rises up (slope up time) to the welding current value gradually until you achieve the preset welding current.

When the torch switch is released, the current begins to drop gradually (slope down time) and when it drops to the minimum current value, the welding output is cut off and the gas valve will close, once the post flow time ends, this is the end of the welding process.

If the torch switch is pressed down during the current downslope period, the current will rise up again to the preset welding current value and the slope out process will only start again once the torch switch to be released.

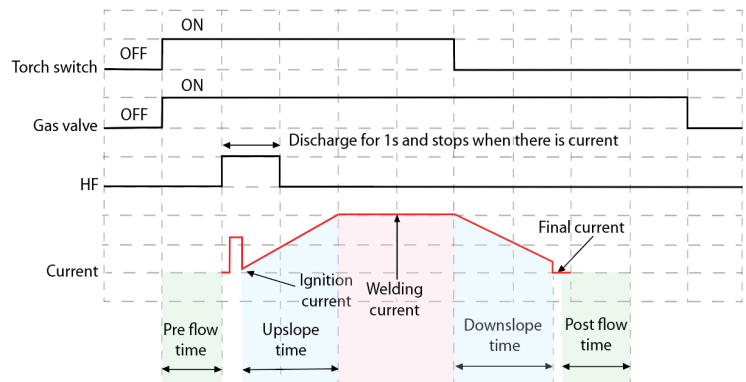

4T (latch trigger control)

The 4T (↕↕) LED will illuminate when the power source is in 4T welding mode, this trigger mode is mainly used for long welding runs to assist in reducing operator finger fatigue. In this mode the user can press and release the torch trigger and the output will remain active until the trigger switch is depressed again and released.

In 4T mode, the gas valve opens when the torch switch is pressed down, after the pre flow time ends, HF discharge occurs which ignites the welding arc. Once the welding arc has successfully ignited the initial current value is active and the torch switch can now be released, the welding current rises up to the preset welding current value gradually and you will continue to weld your material. To finish welding, simply press the torch switch down again and the current will begin to gradually drop (slope out time) to the final current value. When the torch switch is released the current output is cut off and the gas will continue to flow until your preset post flow time has elapsed.

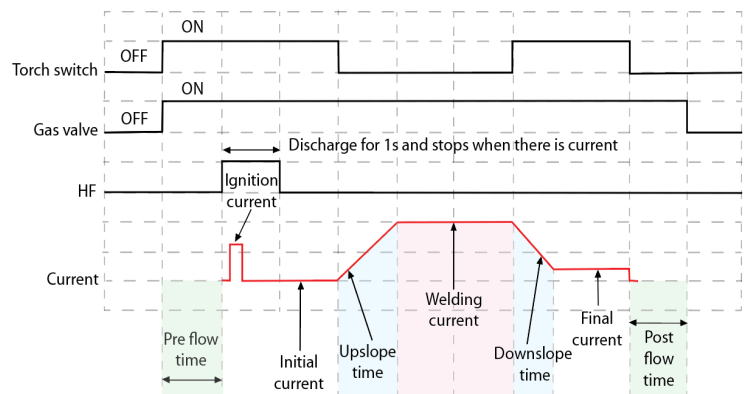

OPERATION - TIG



Before starting any welding activity ensure that you have suitable eye protection and protective clothing. Also take the necessary steps to protect any persons within the welding area.

TIG torch trigger operation steps

Cycle mode

The cycle \updownarrow (□) LED light will illuminate when the power source is in repeating mode, upon pressing the torch trigger switch the gas valve opens and after the pre flow time ends, HF discharge will engage the welding arc. Once the welding arc is ignited successfully, the initial current is present then after the operator releases the torch switch the welding current rises up to the preset welding current value gradually (depending on preset upslope time). When the torch switch is pressed down again, the current begins to drop gradually to the final current arc value. When the torch switch is released again, the current will rise gradually up to the welding current value again. 'Cycle' means the welding current varies between the final arc current value and the welding current value.

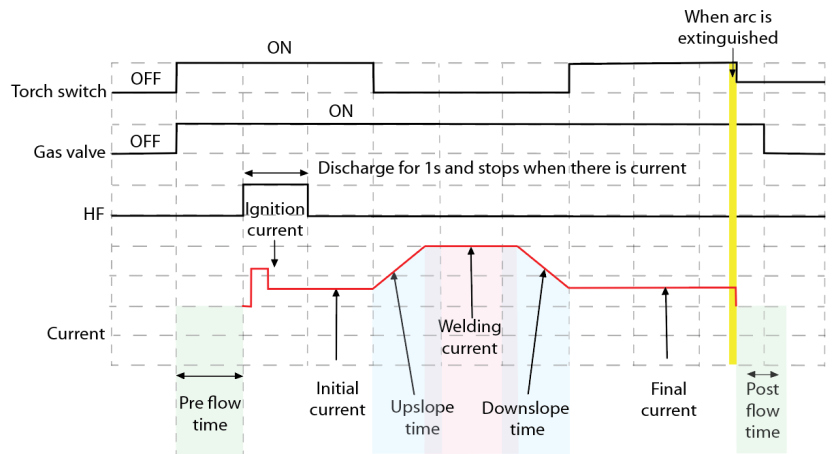

To extinguish the welding arc, press and release the torch trigger briefly (within 1/5 of a second) and the arc will be extinguished immediately and the current output will be shut off. The gas valve will then close when the post flow time ends and the welding process ends.

Spot welding mode

The spot ●●● LED will illuminate when the power source is in spot welding mode.

To set the spot welding time setting, refer to page 24 for selecting and setting the spot time.

On pressing the torch trigger, gas will flow and at the end of the gas pre flow time HF will initiate the welding arc.

Once the welding arc is ignited the welding current is present and no matter if the torch switch is on or off the machine will still offer welding current until the preset spot welding time the user set has timed out and then the welding arc will be extinguished. The gas will continue until the post flow time ends when the welding process ends.

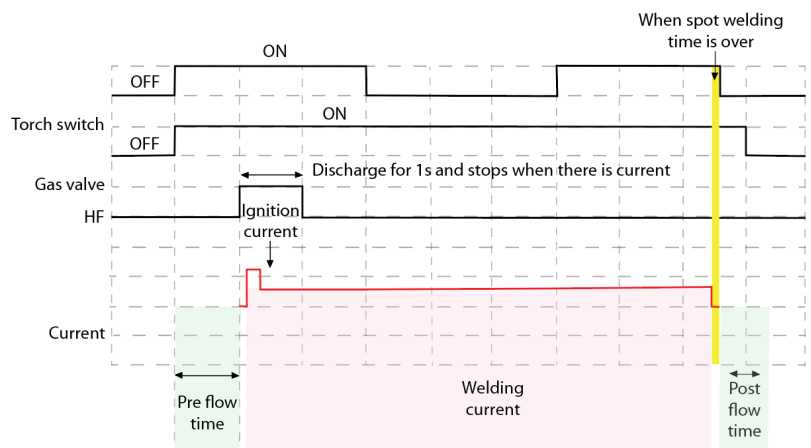

Please note:

Spot welding can only be carried out in HF TIG mode only.

REMOTE CONTROL SOCKET

The Jasic TIG 300P is fitted with 9 pin remote control socket located on the front panel which is used to connect various TIG remote control options, for example, a TIG torch trigger switch a TIG torch mounted current adjustment dial as well as a foot pedal or other similar remote device.

When fitting the 9 pin remote plug, ensure you align the keyway when inserting the plug, then rotate the threaded collar fully clockwise until finger tight.

To select the appropriate remote current control process, press the remote button until the LED is lit alongside your chosen preference.

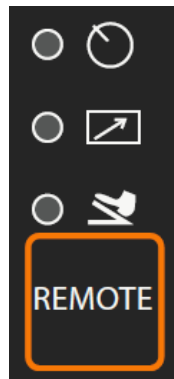

9 Pin Remote socket configuration	
Pin No	Description
1	Potentiometer (min)
2	Potentiometer wiper
3	Potentiometer (max)
6	N/A
7	N/A
8	Torch switch
9	Torch switch

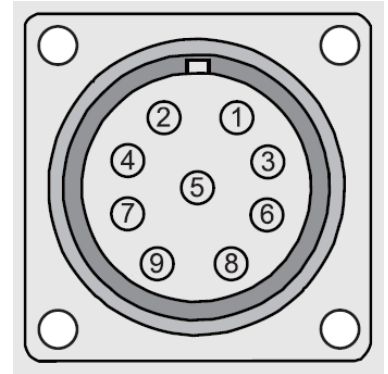

The 9 Pin plug & clamp Pt No is JSG-PLUG-9PIN

Remote device activation



Without welding, press the remote until the panel LED is lit, this indicates that the machine is ready for front panel current control.



Without welding, press the remote until the remote LED is lit, this indicates that the machine is ready for an analog (potentiometer type) type torch control.



Without welding, press the remote until the foot pedal remote LED is lit, this indicates that the machine is ready for a foot pedal type control.

Starparts Titanium Torch (Trigger only) wiring as follows:

Pin 8 - Trigger

Pin 9 - Trigger

Starparts Titanium Torch with analog remote current control

Jasic JFC-08 Foot pedal wiring are as follows:

Pin 1 – Potentiometer Max

Pin 2 – Potentiometer Wiper

Pin 3 – Potentiometer Min

Pin 8 – Trigger

Pin 9 – Trigger

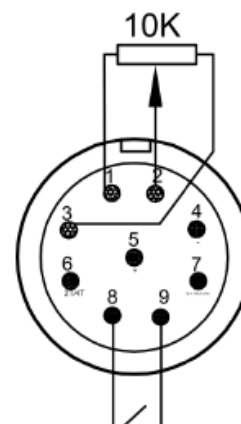

Starparts Titanium Torch with digital current control wiring as follows:

Pin 4 – -

Pin 5 – +

Pin 6 – Parameter selection

Pin 8 – Trigger

Pin 9 – Trigger (Common)

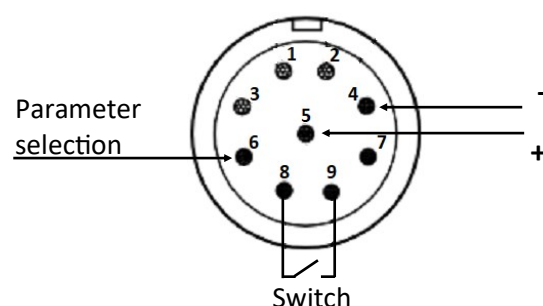

GUIDE TO MMA WELDING



Before starting any welding activity ensure that you have suitable eye protection and protective clothing. Also take the necessary steps to protect any persons within the welding area.

Notes for the welding beginner

This section is designed to give the beginner who has not previously done any welding some information to get them going. The simplest way to start is to practice by running weld beads on a piece of scrap plate. Start by using mild steel (paint free) plate of 6.0mm thick and using 3.2mm electrodes. Clean any grease, oil and loose scale from the plate and fix firmly to your work bench so that welding can be carried out. Make sure that the work return clamp is secure and making good electrical contact with the mild steel plate, either directly or through the work table. For best results always clamp the work lead directly to the material being welded, otherwise you may experience a poor electrical circuit.

Welding position

When welding, ensure you place yourself in a comfortable position for welding and your welding application before you begin to weld. This maybe by sitting at a suitable height which often is the best way to weld ensuring you're relaxed and not tense. A relaxed posture will ensure the welding task becomes much easier.

Please ensure you always wear suitable PPE and use suitable fume extraction when welding.

Place the work so that the direction of welding is across, rather than to or from your body.

The electrode holder lead should always be clear of any obstruction so that you can move your arm freely along as the electrode burns down. Some elders prefer to have the welding lead over their shoulder, this allows greater freedom of movement and can reduce the weight from your hand.

Always inspect your welding equipment, welding cables and electrode holder before each use to ensure it's not faulty or worn as you may be at risk of an electric shock.

MMA process features and benefits

The versatility of the process and the skill level required to learn, basic simplicity of the equipment make the MMA process one of the most common used throughout the world.

The MMA process can be used to weld a wide variety of materials and is normally used in the horizontal position but can be used in vertical or overhead with the correct selection of electrode and current. In addition, it can be used to weld at long distances from the power source subject to the correct cable sizing. The self shielding effect of the electrode coating makes the process suitable for welding in external environments. It is the dominant process used in maintenance and repair industries and is used extensively in structural and fabrication work.

The process is well able to cope with less than ideal material conditions such as dirty or rusty material. Disadvantages of the process are the short welds, slag removal and stop/starts which lead to poor weld efficiency which is in the region of 25%. The weld quality is also highly dependent on the skill of the operator and many welding problems can exist.

GUIDE TO MMA WELDING



Before starting any welding activity ensure that you have suitable eye protection and protective clothing. Also take the necessary steps to protect any persons within the welding area.

MMA process tips and guides

Typical welder set up

1. Electrode holder
2. Work return clamp
3. Work piece
4. Weld material covered by electrode flux or slag
5. Electrode
6. Distance from work to electrode (arc Length)

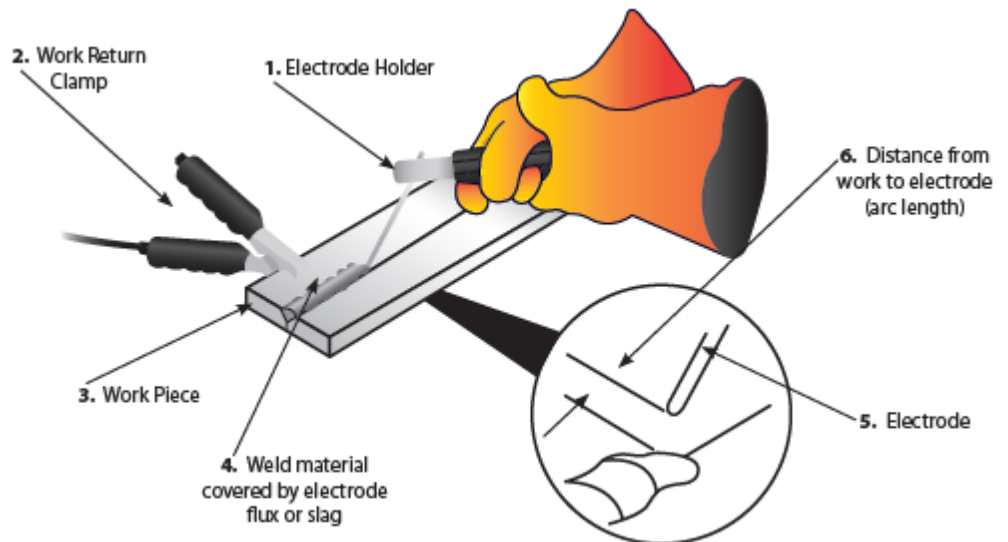

Welding current will flow in the circuit as soon as the electrode contacts the work piece. The welder should always ensure a good connection of the work clamp. The nearer the clamp is placed to the welding area the better.

When the arc is struck the distance between the end of the electrode and the work will determine the arc voltage and also affect the weld characteristic. As a guide the arc length for electrodes up to 3.2mm diameter should be around 1.6mm and over 3.2mm around 3mm.

Upon completion of the weld the welding flux or slag will need to be removed usually with a chipping hammer and wire brush.

Joint form in MMA

In MMA welding, the common basic joint forms: butt joint, corner joint, lap joint & T joint.

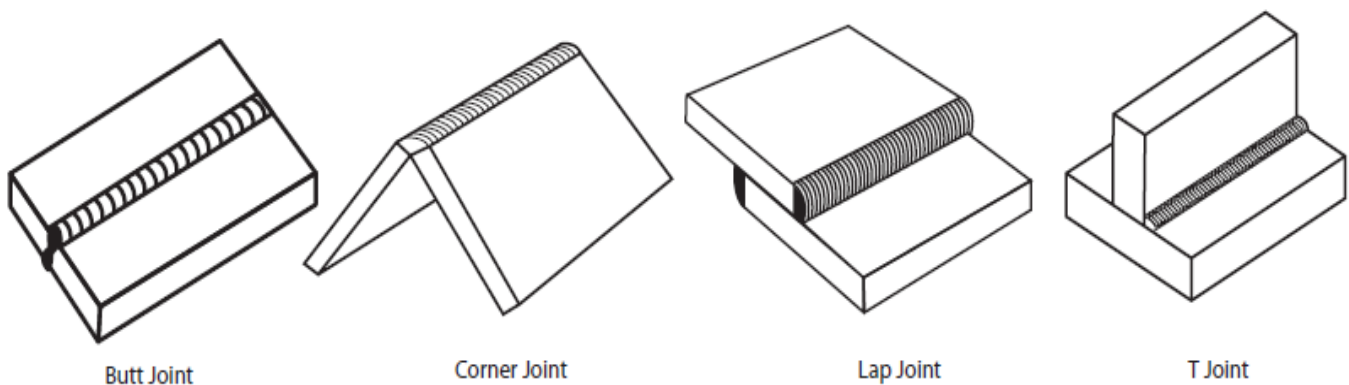

GUIDE TO MMA WELDING



Before starting any welding activity ensure that you have suitable eye protection and protective clothing. Also take the necessary steps to protect any persons within the welding area.

MMA arc striking

Tap technique - Lift the electrode upright and bring it down to strike the work piece. After forming short circuit, quickly lift up about 2~4mm and arc will be ignited. This method is difficult to master.

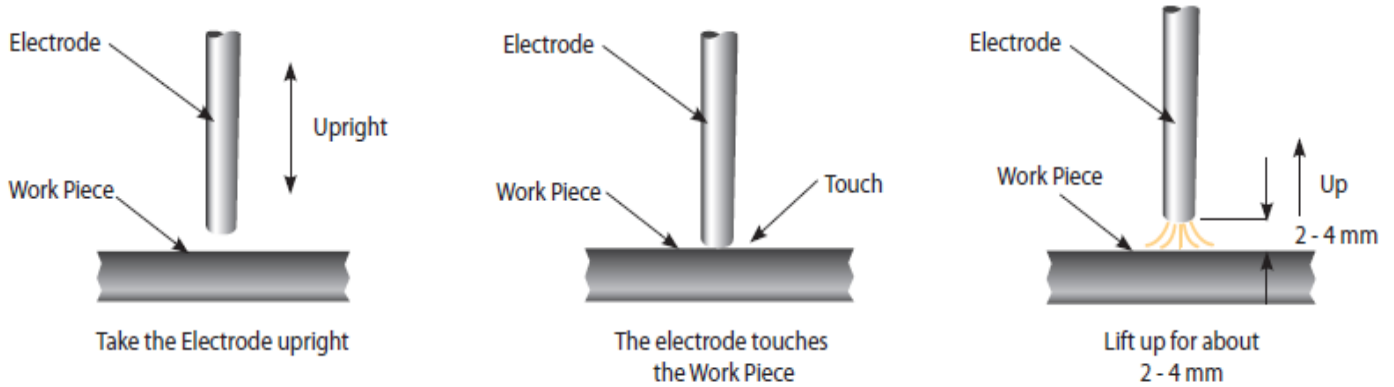

Scratch technique - Drag the electrode and scratch the work piece as if striking a match. Scratching the electrode may cause the arc to burn along the scratch path, so care should be taken to scratch in the weld zone. When the arc is struck adopt the correct welding position.

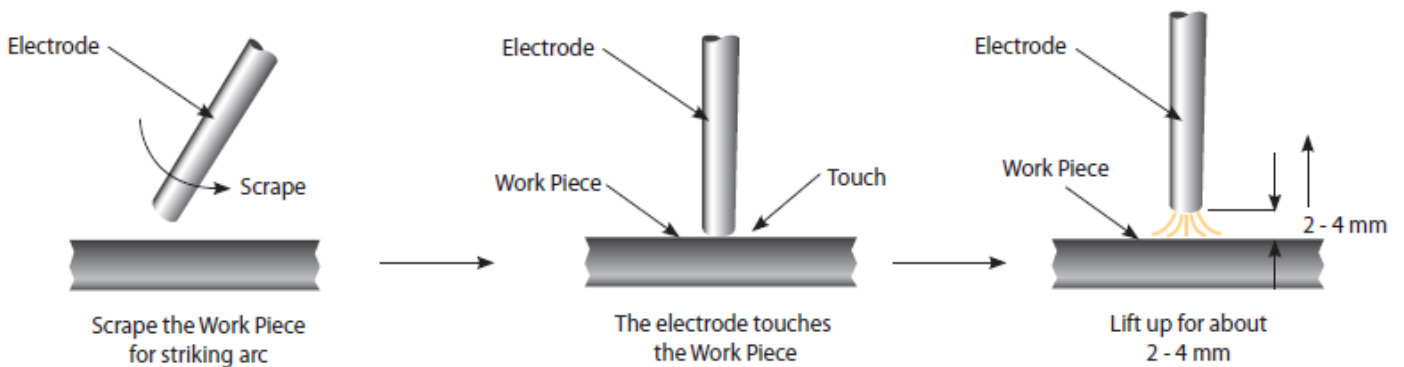

Electrode positioning

Horizontal or flat position

The electrode should be positioned at right angles to the plate and inclined in the direction of travel at around 10°-30°.

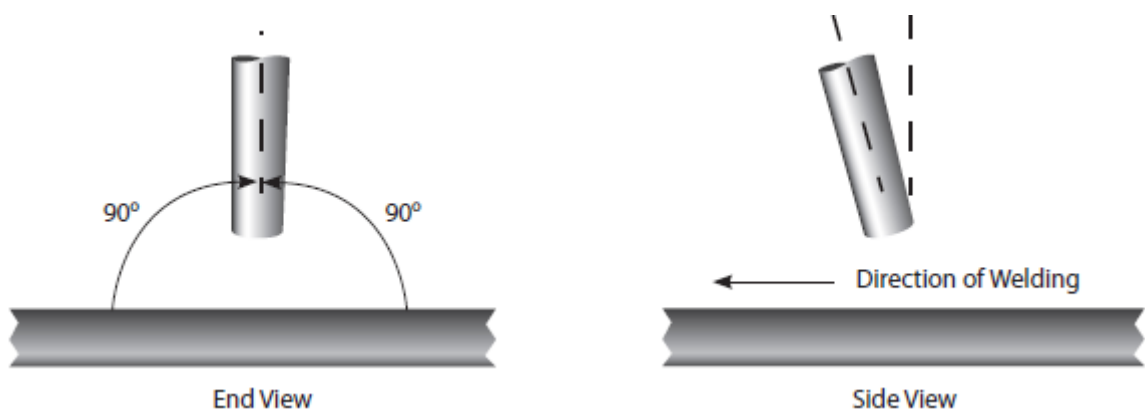

GUIDE TO MMA WELDING



Before starting any welding activity ensure that you have suitable eye protection and protective clothing. Also take the necessary steps to protect any persons within the welding area.

Fillet welding

The electrode should be positioned to split the angle i.e. 45° . Again the electrode should be inclined in the direction of travel at around 10° - 30° .

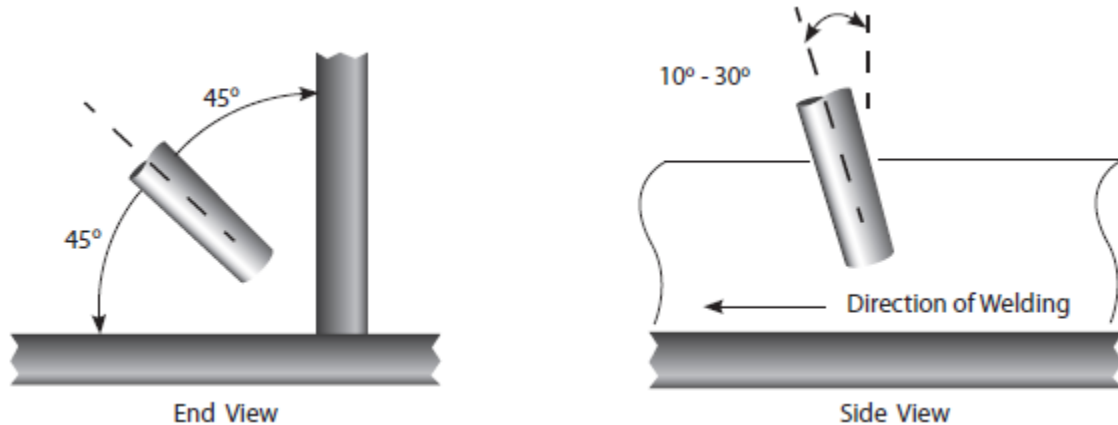

Manipulation of electrode

In MMA welding there are three motions used at the end of electrode:

1. The electrode feeding to the molten pool along axis
2. The electrode swing right and left
3. The electrode moving in the weld direction

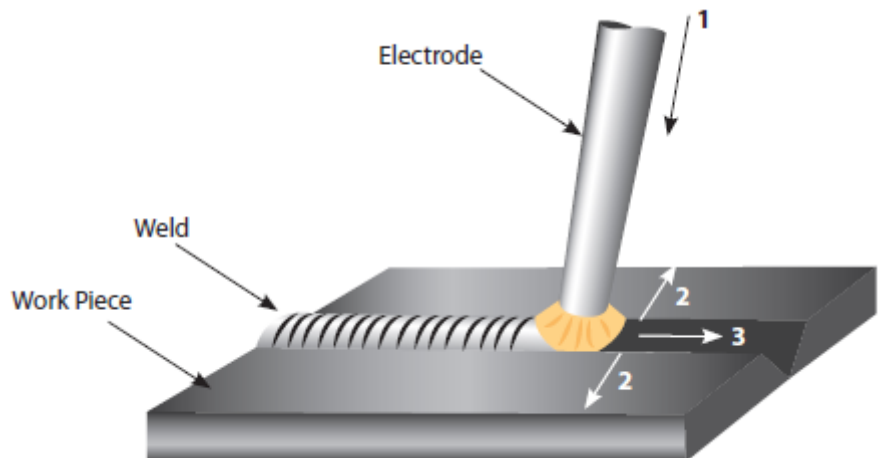

The operator can choose the manipulation of electrode based on welding joint, welding position, electrode spec, welding current and operation skill etc.

Weld characteristics

A good weld bead should exhibit the following characteristics:

1. Uniform weld bead
2. Good penetration into the base material
3. No overlap
4. Fine spatter level

A poor weld bead should exhibit the following characteristics:

1. Uneven and erratic bead
2. Poor penetration into the base material
3. Bad overlap
4. Excessive spatter levels
5. Weld crater

MMA WELDING PROBLEMS



Before starting any welding activity ensure that you have suitable eye protection and protective clothing. Also take the necessary steps to protect any persons within the welding area.

Arc welding defects and prevention methods

<u>Defect</u>	<u>Possible cause</u>	<u>Action</u>
Excessive spatter (beads of metal scattered around the weld area)	Amperage too high for the selected electrode	Reduce amperage or utilise larger diameter electrode
	Voltage too high or arc length too long	Reduce arc length or voltage
Uneven and erratic weld bead and direction	Weld bead is inconsistent and misses joint due to operator	Operator training required
Lack of penetration – The weld bead fails to create complete fusion between material to be welded, often surface appears okay but weld depth is shallow	Poor joint preparation	Joint design must allow for full access to the root of the weld
	Insufficient heat input	Material too thick Increase the amperage or increase the electrode size and amperage
	Poor weld technique	Reduce travel speed Ensure the arc is on the leading edge of the weld puddle
Porosity – Small holes or cavities on the surface or within the weld material	Work piece dirty	Remove all contaminant from the material i.e. oil, grease, rust, moisture prior to welding
	Electrode is damp	Replace or dry the electrode
	Arc length is excessive	Reduce the arc length
Excessive penetration – The weld metal is below the surface level of the material and hangs below	Heat input too high	Reduce the amperage or use a smaller electrode and lower amperage
	Poor weld technique	Use correct welding travel speed
Burning through – Holes within the material where no weld exists	Heat input too high	Use lower amperage or smaller electrode Use correct welding travel speed
Poor fusion – Failing of weld material to fuse either with the material to be welded or previous weld beads	Insufficient heat level	Increase the amperage or increase the electrode size and amperage
	Poor welding technique	Joint design must allow for full access to the root of the weld Alter welding technique to ensure penetration such as weaving, arc positioning or stringer bead technique
	Work piece dirty	Remove all contaminant from the material i.e. oil, grease, rust, moisture prior to welding

GUIDE TO TIG WELDING



Before starting any welding activity ensure that you have suitable eye protection and protective clothing. Also take the necessary steps to protect any persons within the welding area.

TIG torch body and components

The torch body holds the various welding consumables in place as shown and is covered by either a rigid phenolic or rubberised covering.

Collet body



The collet body screws into the torch body. It is replaceable and is changed to accommodate the different sizes tungstens and their respective collets.

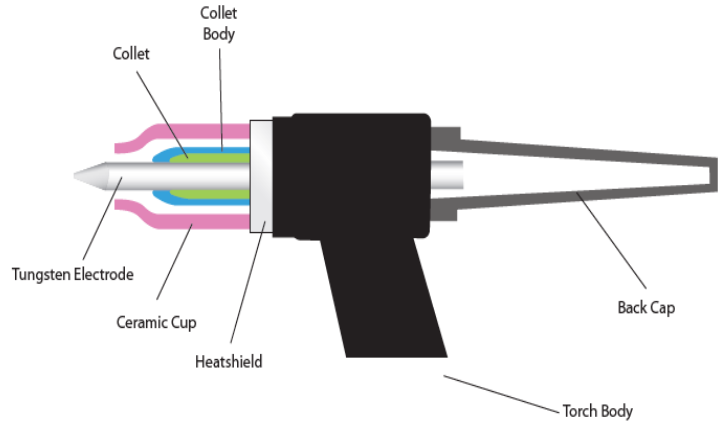

Collets



The welding electrode (tungsten) is held in the torch by the collet. The collet is usually made of copper or a copper alloy. The collet's grip on the electrode is secured when the torch back cap is tightened in place. Good electrical contact between the collet and tungsten electrode is essential for good welding current transfer.

Gas lens body

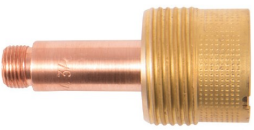

A gas lens is a device that can be used in place of the normal collet body. It screws into the torch body and is used to reduce turbulence in the flow of shield gas and produce a stiff column of undisturbed flow of shielding gas. A gas lens will allow the welder to move the nozzle further away from the joint allowing increased visibility of the arc.

A much larger diameter nozzle can be used which will produce a large blanket of shielding gas. This can be very useful in welding material like titanium. The gas lens will also enable the welder to reach joints with limited access such as inside corners.

Ceramic cups



Gas cups are made of various types of heat resistant materials in different shapes, diameters and lengths. The cups are either screwed onto the collet body or gas lens body or in some cases pushed in place. Cups can be made of ceramic, metal, metal-jacketed ceramic, glass or other materials. The ceramic type is quite easily broken so take care when putting the torch down.

Gas cups must be large enough to provide adequate shielding gas coverage to the weld pool and surrounding area. A cup of a given size will allow only a given amount of gas to flow before the gas flow becomes disturbed due to the speed of flow. Should this condition exist the size of cup should be increased to allow the flow speed to reduce and once again establish an effective regular shield.

Back cap

The back cap screws into the rear on the torch head and applies pressure to the back end of the collet which in turn forces up against the collet body, the resulting pressure holds the tungsten in place to ensure it does not move during the welding process.

Back caps are made from a rigid phenolic material and generally come in 3 sizes, short, medium and long.

GUIDE TO TIG WELDING



Before starting any welding activity ensure that you have suitable eye protection and protective clothing. Also take the necessary steps to protect any persons within the welding area.

TIG welding electrodes

TIG welding electrodes are a 'non consumable' as it is not melted into the weld pool and great care should be taken not to let the electrode contact the welding pool to avoid weld contamination. This would be referred to as tungsten inclusion and may result in weld failure.

Electrodes will often contain small quantities of metallic oxides which can offer the following benefits:

- Assist in arc starting
- Improve current carrying capacity of the electrode
- Reduce the risk of weld contamination
- Increase electrode life
- Increase arc stability

Oxides used are primarily zirconium, thorium, lanthanum or cerium. These are added usually 1% - 4%.



Tungsten Electrode Colour Chart - DC

Welding Mode	Tungsten Type	Colour
DC or AC/DC	Ceriated 2%	Grey
DC or AC/DC	Lanthanated 1%	Black
DC or AC/DC	Lanthanated 1.5%	Gold
DC or AC/DC	Lanthanated 2%	Blue
DC	Thoriated 1%	Yellow
DC	Thoriated 2%	Red

Tungsten Electrode Current Ranges

Tungsten Electrode Size	DC Current Amp
1.0mm	30 - 60
1.6mm	60 - 115
2.4mm	100 - 165
3.2mm	135 - 200
4.0mm	190 - 280
4.8mm	250 - 340

Tungsten electrode preparation - DC

When welding at low current the electrode can be ground to a point. At higher current a small flat on the end of the electrode is preferable as this helps with arc stability.

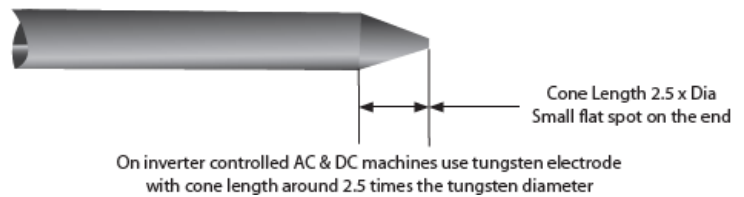

Electrode grinding

It is important when grinding the electrode to take all necessary precautions such as wearing eye protection and ensuring adequate protection against breathing in any grinding dust.

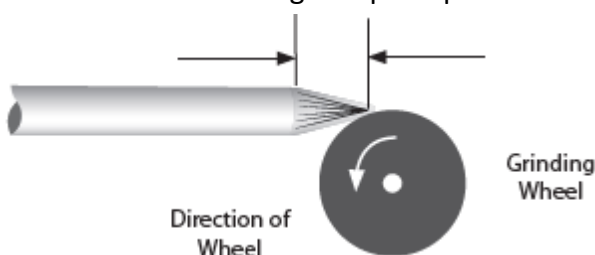

Tungsten electrodes should always be ground lengthwise (as shown) and not in a radial operation. Electrodes ground in a radial operation tend to contribute to arc wander due to the arc transfer from the grinding pattern. Always use a grinder solely for grinding electrodes to avoid contamination.

GUIDE TO TIG WELDING



Before starting any welding activity ensure that you have suitable eye protection and protective clothing. Also take the necessary steps to protect any persons within the welding area.

TIG welding consumables

The consumables of the TIG welding process are filler wires and shield gas.

Filler wires

Filler wires come in many different material types and usually as cut lengths, unless some automated feeding is required where it will be in reel form. Filler wire is generally fed in by hand. Always consult the manufacturer's data and welding requirements.

Filler Wire Diameter	DC Current Range (Amps)
1.0mm	20-90
2.4mm	65-115
3.2mm	100-165
4.8mm	200-350

Filler Wire Selection Guide

Gases

Shielding gas is required when welding to keep the weld pool free of oxygen. Whether you are welding mild steel or stainless steel the most commonly used shielding gas used in TIG welding is argon, for more specialised applications an argon helium mix or pure helium maybe used.

TIG welding - arc starting

The TIG process can use both non contact and contact methods to provide arc starting. Depending on the Jasic model, the options are indicated on a selector switch on the front control panel of the power source. The most common method of arc starting is 'HF' start. This term is often used for a variety of starting methods and covers many different types of start.

Arc starting - scratch start

This system is where the electrode is scratched along the work piece like striking a match. This is a basic way of turning any DC stick welder into a TIG welder without much work. It is not considered suitable for high integrity welding due to the fact that the tungsten can be melted on the work piece thereby contaminating the weld.

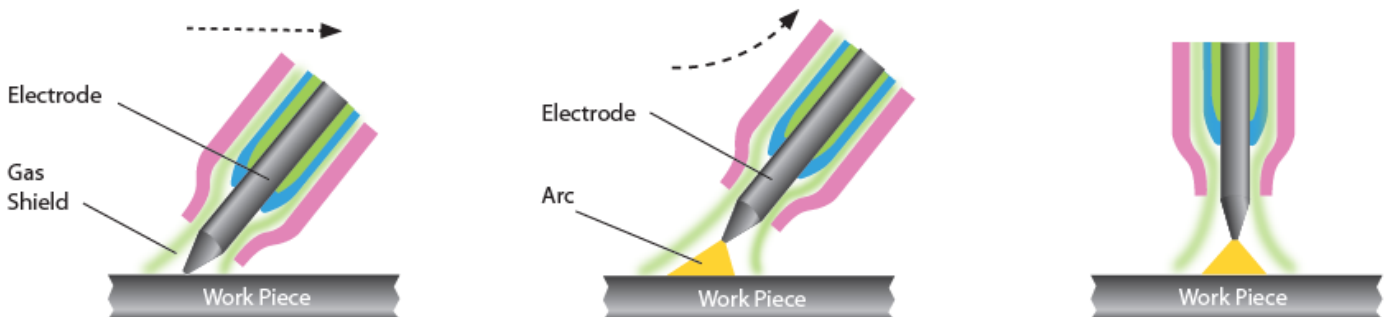

The main challenge with scratch start TIG welding is keeping your electrode clean. While a quick strike with the electrode on the metal is essential and then not lifting it more than 3mm away to create the arc will help, you also need to ensure your metal is completely clean.

GUIDE TO TIG WELDING



Before starting any welding activity ensure that you have suitable eye protection and protective clothing. Also take the necessary steps to protect any persons within the welding area.

Arc starting - lift TIG (lift arc)

Not to be confused with scratch start, this arc starting method allows the tungsten to be in direct contact with the work piece first but with minimal current so as not to leave a tungsten deposit when the tungsten is lifted and an arc is established.

With lift TIG start the open circuit voltage (OCV) of the welder folds back to a very low voltage output when the unit senses the tungsten has made continuity with the work piece. Once the torch is lifted the unit increases output as the tungsten leaves the surface. This creates little contamination and preserves the point on the tungsten although this is still not a 100% clean process. The tungsten still can get contaminated but lift TIG is still a much better option than scratch starting, for mild and stainless steel although these methods of arc starting are not a good option when welding aluminium.

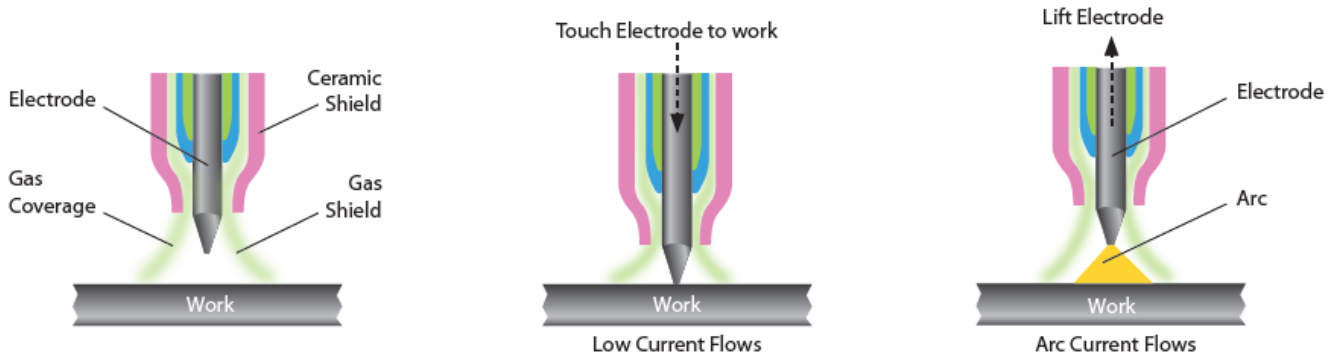

Arc starting - HF start

Non contact High Frequency (HF) start method is a high voltage and low amperage generated using a spark gap assembly and is the most popular and generally considered best TIG arc starting method. The High Frequency (HF) start generates a high frequency arc that ionizes the gas bridging the gap between the tungsten point and the work piece. This touch-less method creates almost no contamination unless the tungsten has been over sharpened or the start amperage is too high. It is an excellent choice for all material being welded especially aluminium although unless you need to weld aluminium, you don't have to use HF start steel/stainless.

The HF frequency varies with the spark gap and can be around 16000 Hz to 100000 Hz depending on spark gap width so consideration should be given with this method as it can cause electrical interference to nearby electrical equipment such as computers, CNC controls and phone systems.

If the spark gap is widened, the HF can become erratic.



GUIDE TO DC TIG WELDING



Before starting any welding activity ensure that you have suitable eye protection and protective clothing. Also take the necessary steps to protect any persons within the welding area.

DC TIG welding

Direct current welding is when the current flows in one direction only. Compared with AC welding the current once flowing will not go to zero until welding has ended.

The Jasic TIG Series polarity should generally be set up for Direct Current - Electrode Negative (DCEN) as this method of welding can be used for a wide range of materials.

The TIG welding torch is connected to the negative output of the machine and the work return cable to the positive output.

When the arc is established the current flows in the circuit and the heat distribution in the arc is around 33% in the negative side of the arc (the welding torch) and 67% in the positive side of the arc (the work piece). This balance gives deep arc penetration of the arc into the work piece and reduces heat in the electrode.

This reduced heat in the electrode allows more current to be carried by smaller electrodes compared to other polarity connections. This method of connection is often referred to as straight polarity and is the most common connection used in DC welding.

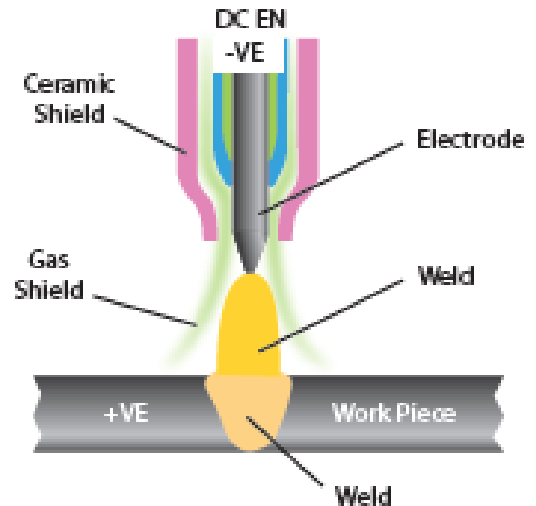

TIG welding techniques

- Before welding (especially with mild steel) you should ensure all material being welded are clean, as particulates can weaken the weld.
- The torch angle is best kept at 15 - 20° (from vertical) away from the direction of travel. This assists with visibility of the weld area and allows easier access for the filler material.
- The filler metal should be fed in at a low angle to help avoid touching the tungsten electrode and contaminating it.
- The TIG welding arc melts the base material and the molten puddle melts the filler rod, it is important you resist the urge to melt the filler material directly into the welding arc.
- For thinner sheet materials, a filler material may not be needed.
- Prepare the tungsten correctly, using a diamond grinding wheel will give you the best results for a sharp point (see page 35).
- For welding stainless steel, be careful of applying too much heat. If the colour is dark grey and looks dirty and heavily oxidized then too much heat has been applied, this could also cause the material to warp. Reducing the amperage and increase travel speed may correct this problem, you could also consider using a smaller diameter filler material, as that will require less energy to melt.

See the following page for a TIG DC welding amperage guide

GUIDE TO DC TIG WELDING



Before starting any welding activity ensure that you have suitable eye protection and protective clothing. Also take the necessary steps to protect any persons within the welding area.

Manual DC TIG Welding Amperage Guide- Mild Steel and Stainless Steel

Base Metal Thickness mm	Base Metal Thickness Inch	Tungsten Electrode Diameter	Output Polarity	Filler Wire Diameter (If Required)	Argon Gas Flow Rate (Litres/Min)	Joint Types	Amperage Range
1.6mm	1/16"	1.6mm	DC	1.6mm	5 - 8	Butt	50 - 80
1.6mm	1/16"	1.6mm	DC	1.6mm	5 - 8	Corner	50 - 80
1.6mm	1/16"	1.6mm	DC	1.6mm	5 - 8	Fillet	60 - 90
1.6mm	1/16"	1.6mm	DC	1.6mm	5 - 8	Lap	60 - 90
2.4mm	3/32"	1.6/2.4mm	DC	1.6/2.4mm	5 - 9	Butt	80 - 110
2.4mm	3/32"	1.6/2.4mm	DC	1.6/2.4mm	5 - 9	Corner	80 - 110
2.4mm	3/32"	1.6/2.4mm	DC	1.6/2.4mm	5 - 9	Fillet	90 - 120
2.4mm	3/32"	1.6/2.4mm	DC	1.6/2.4mm	5 - 9	Lap	90 - 120
3.2mm	1/8"	2.4mm	DC	2.4mm	5 - 10	Butt	80 - 120
3.2mm	1/8"	2.4mm	DC	2.4mm	5 - 10	Corner	90 - 120
3.2mm	1/8"	2.4mm	DC	2.4mm	5 - 10	Fillet	100 - 140
3.2mm	1/8"	2.4mm	DC	2.4mm	5 - 10	Lap	100 - 140
4.8mm	3/16"	2.4mm	DC	2.4mm	6 - 11	Butt	120 - 200
4.8mm	3/16"	2.4mm	DC	2.4mm	6 - 11	Corner	150 - 200
4.8mm	3/16"	2.4mm	DC	2.4mm	6 - 11	Fillet	170 - 220
4.8mm	3/16"	2.4mm	DC	2.4mm	6 - 11	Lap	150 - 200
6.4mm	1/4"	2.4mm	DC	3.2mm	7 - 12	Butt	225 - 300
6.4mm	1/4"	2.4mm	DC	3.2mm	7 - 12	Corner	250 - 300
6.4mm	1/4"	2.4mm	DC	3.2mm	7 - 12	Fillet	250 - 320
6.4mm	1/4"	2.4mm	DC	3.2mm	7 - 12	Lap	250 - 320
9.5mm	3/8"	3.2mm	DC	3.2mm	7 - 12	Butt	250 - 360
9.5mm	3/8"	3.2mm	DC	3.2mm	7 - 12	Corner	260 - 360
9.5mm	3/8"	3.2mm	DC	3.2mm	7 - 12	Fillet	270 - 380
9.5mm	3/8"	3.2mm	DC	3.2mm	7 - 12	Lap	230 - 380
12.7mm	1/2"	3.2/4mm	DC	3.2mm	8 - 13	Butt	300 - 400
12.7mm	1/2"	3.2/4mm	DC	3.2mm	8 - 13	Corner	320 - 420
12.7mm	1/2"	3.2/4mm	DC	3.2mm	8 - 13	Fillet	320—420
12.7mm	1/2"	3.2/4mm	DC	3.2mm	8 - 13	Lap	320 - 420

Please Note:

- All above guide settings are approximate and will vary depending on application, prep, passes and type of welding equipment used.
- The welds would need to be tested to ensure they comply to your welding specifications.

GUIDE TO TIG WELDING

JT-300P DC Welding Basic Set-Up Guide

For DC TIG welding, set up as below and ensure you place the machine in DC and 2T mode.

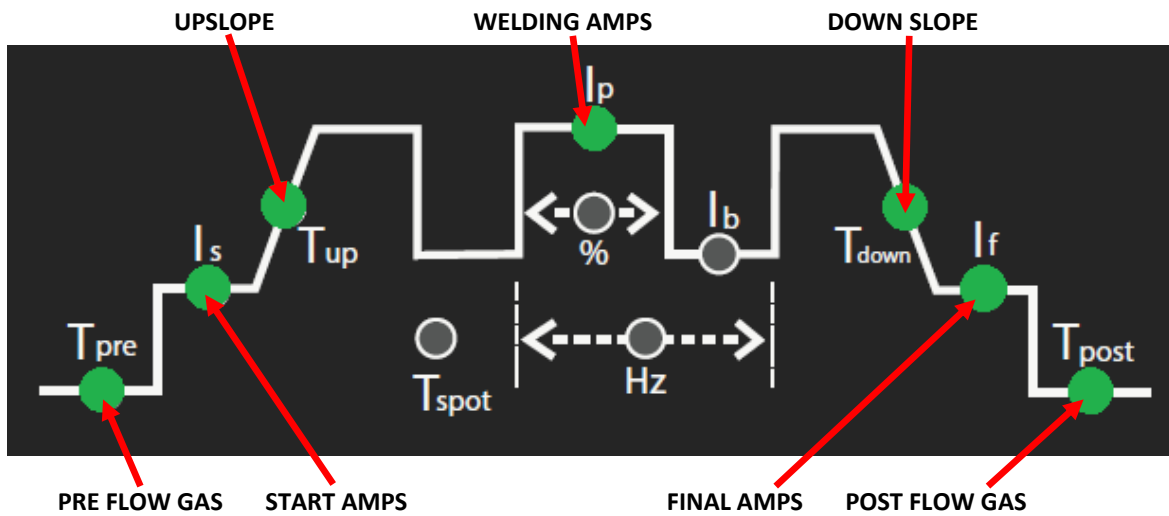
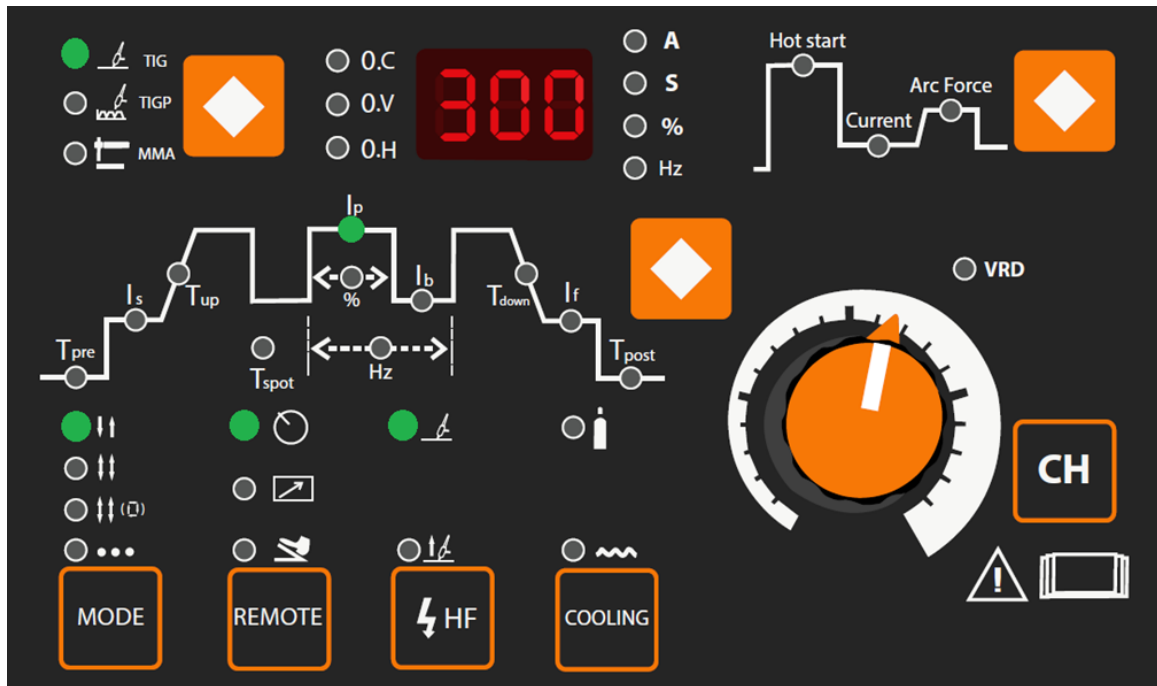

Set parameters as follows using control panel image above as reference:

Parameter	Units	Adjustable Range	Guide Setting	User Setting
Job/Material	---	---	---	
PRE-GAS TIME	Seconds	0 ~ 15	0.5	
START-CURRENT	Amps	5 ~ 300	15	
UP-SLOPE TIME	Seconds	0 ~ 10	0	
PEAK CURRENT *	Amps	5 ~ 300	User defined *	
DOWN-SLOPE TIME	Seconds	0 ~ 10	1	
FINAL CURRENT	Amps	5 ~ 300	10	
POST-GAS TIME	Seconds	0.5 ~ 15	2	

* Depends on material thickness (30A per mm) eg. 3mm = 90A

Please Note: Ensure you have set the water cooling option to ON/OFF depending on TIG Torch type fitted

GUIDE TO TIG WELDING

JT-300P DC Welding Basic Set-Up Guide

For DC TIG welding, set up as below and ensure you place the machine in DC, pulse and 2T mode.

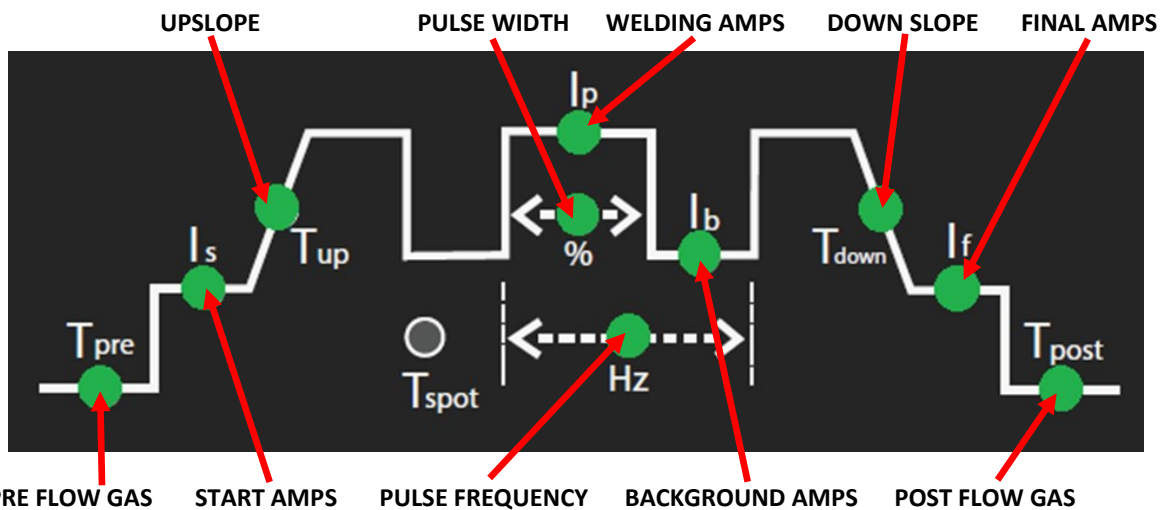
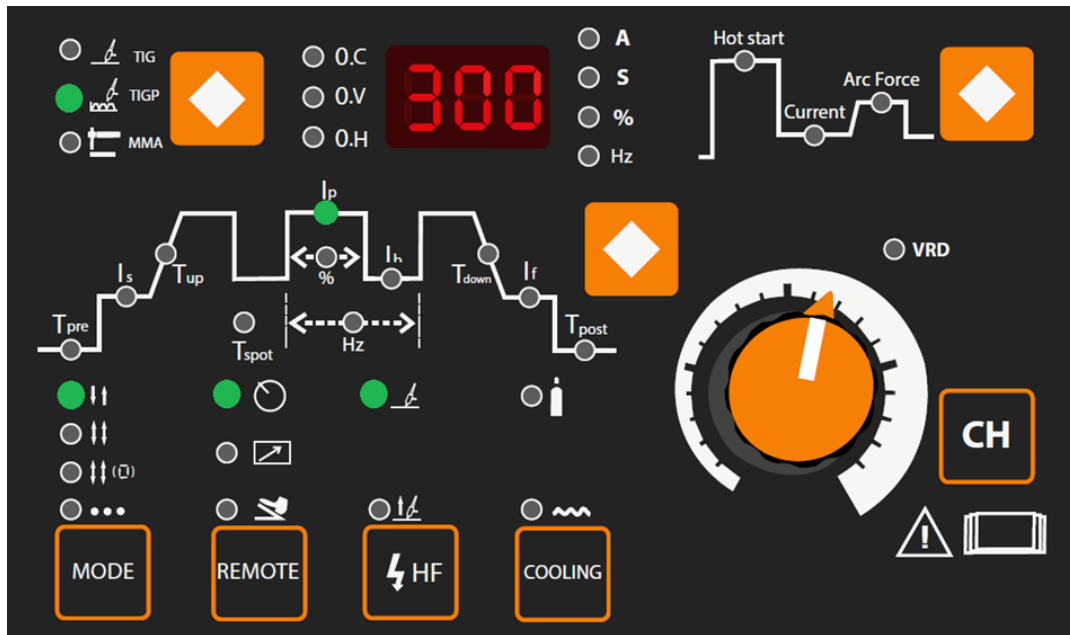

Set parameters as follows using control panel image above as reference:

Parameter	Units	Adjustable Range	Guide Setting	User Setting
Job/Material	---	---	---	
PRE-GAS TIME	Seconds	0 ~ 15	0.5	
START-CURRENT	Amps	5 ~ 300	15	
UP-SLOPE TIME	Seconds	0 ~ 10	0	
PEAK CURRENT *	Amps	5 ~ 300	User defined *	
BASE CURRENT **	Amps	5 ~ 300	50% **	
PULSE FREQUENCY	Hz	0.5 ~ 200	1	
PULSE WIDTH	%	10 ~ 90	50	
DOWN-SLOPE TIME	Seconds	0 ~ 10	1	
FINAL CURRENT	Amps	5 ~ 300	10	
POST-GAS TIME	Seconds	0.5 ~ 15	2	

* Depends on material thickness (30A per mm) eg. 3mm = 90A

** Set base current to 50% of your peak welding current

Please Note: Ensure you have set the water cooling option to ON/OFF depending on TIG Torch type fitted

TIG TORCH SPARE PARTS LIST

TIG Welding Torch Air Cooled - Model TIG-79ERGO

Rating 200A DC, 150A AC @ 60% Duty Cycle EN60974-7 • 0.5mm to 4.0mm Electrodes

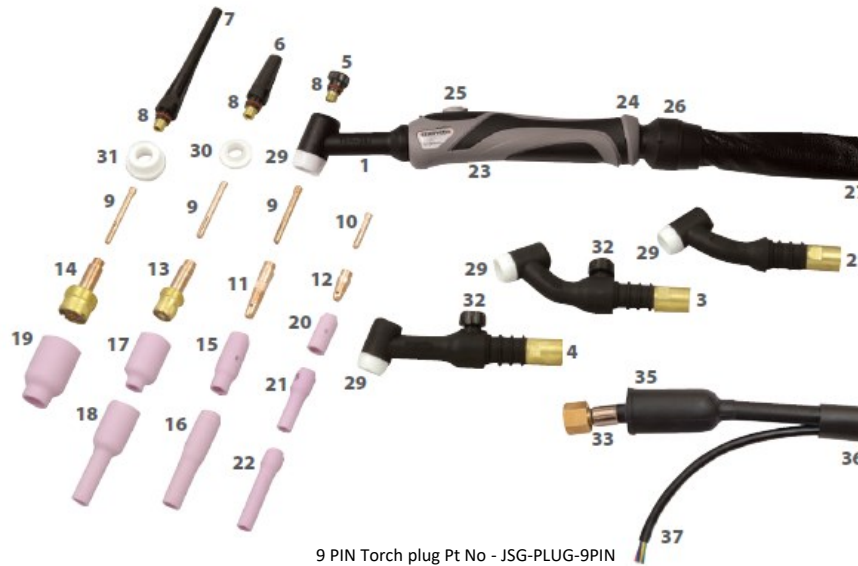

9 PIN Torch plug Pt No - JSG-PLUG-9PIN

Consumables

Model: T26

Main Consumables

Code	Description	Pack Qty
1	WP26 Rigid Torch Body	1
2	WP26F Flexible Torch Body	1
3	WP26FV Flexible Torch Body c/w Argon Valve	1
4	WP26V Torch Body c/w Argon Valve	1
5	57Y04 Short Back Cap	1
6	300M Medium Back Cap	1
7	57Y02 Long Back Cap	1
8	98W18 Back Cap O' Ring	10

Collets

Code	Description	Pack Qty
9	10N21 Standard .020" (0.5mm)	5
	10N22 Standard .040" (1.0mm)	5
	10N23 Standard 1/16" (1.6mm)	5
	10N26 Standard 5/64" (2.0mm)	5
	10N24 Standard 3/32" (2.4mm)	5
	10N25 Standard 1/8" (3.2mm)	5
	54N20 Standard 5/32" (4.0mm)	5
10	10N21S Stubby .020" (0.5mm)	5
	10N22S Stubby .040" (1.0mm)	5
	10N23S Stubby 1/16" (1.6mm)	5
	10N24S Stubby 3/32" (2.4mm)	5
	10N25S Stubby 1/8" (3.2mm)	5

Collet Bodies

Code	Description	Pack Qty
11	10N29 Standard .020" (0.5mm)	5
	10N30 Standard .040" (1.0mm)	5
	10N31 Standard 1/16" (1.6mm)	5
	10N31M Standard 5/64" (2.0mm)	5
	10N32 Standard 3/32" (2.4mm)	5
	10N28 Standard 1/8" (3.2mm)	5
	406488 Standard 5/32" (4.0mm)	5
12	17CB20 Stubby .020" - 1/8" (0.5 - 3.2mm)	5

Gas Lens Bodies

Code	Description	Pack Qty
13	45V29 Standard .020" (0.5mm)	1
	45V24 Standard .040" (1.0mm)	1
	45V25 Standard 1/16" (1.6mm)	1
	45V25M Standard 5/64" (2.0mm)	1
	45V26 Standard 3/32" (2.4mm)	1
	45V27 Standard 1/8" (3.2mm)	1
	45V28 Standard 5/32" (4.0mm)	1
14	45V0204 Large Dia .020"-.040" (0.5 - 1.0mm)	1
	45V116 Large Dia 1/16" (1.6mm)	1
	45V64 Large Dia 3/32" (2.4mm)	1
	995795 Large Dia 1/8" (3.2mm)	1
	45V63 Large Dia 5/32" (4.0mm)	1

Ceramic Cups

Code	Description	Pack Qty
15	10N50 Standard Cup 1/4" Bore	10
	10N49 Standard Cup 5/16" Bore	10
	10N48 Standard Cup 3/8" Bore	10
	10N47 Standard Cup 7/16" Bore	10
	10N46 Standard Cup 1/2" Bore	10
	10N45 Standard Cup 5/8" Bore	10
	10N44 Standard Cup 3/4" Bore	10

Ceramic Cups (continued)

Code	Description	Pack Qty
16	10N50L Long Cup 1/4" Bore	10
	10N49L Long Cup 5/16" Bore	10
	10N48L Long Cup 3/8" Bore	10
	10N47L Long Cup 7/16" Bore	10

Gas Lens Cups

Code	Description	Pack Qty
17	54N18 Standard Cup 1/4" Bore	10
	54N17 Standard Cup 5/16" Bore	10
	54N16 Standard Cup 3/8" Bore	10
	54N15 Standard Cup 7/16" Bore	10
	54N14 Standard Cup 1/2" Bore	10
	54N19 Standard Cup 11/16" Bore	10
18	54N17L Long Cup 5/16" Bore	10
	54N16L Long Cup 3/8" Bore	10
	54N15L Long Cup 7/16" Bore	10
	54N14L Long Cup 1/2" Bore	10
19	57N75 Large Dia Cup 3/8" Bore	5
	57N74 Large Dia Cup 1/2" Bore	5
	53N88 Large Dia Cup 5/8" Bore	5
	53N87 Large Dia Cup 3/4" Bore	5

Ceramic Cups for use with item 12

Code	Description	Pack Qty
20	13N08 Standard Cup 1/4" Bore	10
	13N09 Standard Cup 5/16" Bore	10
	13N10 Standard Cup 3/8" Bore	10
	13N11 Standard Cup 7/16" Bore	10
	13N12 Standard Cup 1/2" Bore	10
	13N13 Standard Cup 5/8" Bore	10
21	796F70 Long Cup 3/16" Bore	10
	796F71 Long Cup 1/4" Bore	10
	796F72 Long Cup 5/16" Bore	10
	796F73 Long Cup 3/8" Bore	10
22	796F74 X - Long Cup 3/16" Bore	10
	796F75 X - Long Cup 1/4" Bore	10
	796F76 X - Long Cup 5/16" Bore	10
	796F77 X - Long Cup 3/8" Bore	10

Secondary Consumables

Code	Description	Pack Qty
23	SP9110 LH & RH Handle Shell	1
24	SP9111 Handle Screw	1
25	SP9120 Single Button Switch	1
	SP9121 2 Button Switch	1
	SP9122 5K Potentiometer Switch	1
	SP9123 10K Potentiometer Switch	1
	SP9128 47K Potentiometer Switch	1
	SP9129 4 Button Switch	1
26	SP9114 Handle Ball Joint	1
27	SP9117 Leather Cover 800mm	1
28	SP9119 Cable Cover Joint (not illustrated)	1
29	18CC Standard Heat Shield	1
30	54N01 Gas Lens Heat Shield	1
31	54N63 Large Gas Lens Insulator	1
32	VS-1 Valve Stem WP26V & WP26FV	1
33	46V28 Mono Power Cable Assy 12.5ft - 3/8" Bsp	1
	46V30 Mono Power Cable Assy 25ft - 3/8" Bsp	1
34	46V28-2D 2 Piece Power Cable Assy 12.5ft - Dinse / 3/8" Bsp	1
	46V30-2D 2 Piece Power Cable Assy 25ft - Dinse / 3/8" Bsp	1
35	0315071 Insulation Boot	5
36	6091 Neoprene Protective Cover	1m
37	SP9126 4m Switch Cable c/w 5 Pin Receptacle	1
	SP9127 8m Switch Cable c/w 5 Pin Receptacle	1

TIG TORCH SPARE PARTS LIST



TIG Welding Torch Water Cooled - Model TIG-83ERGO

Rating 350A DC, 260A AC @ 100% Duty Cycle EN60974-7 • 0.5mm to 4.0mm Electrodes

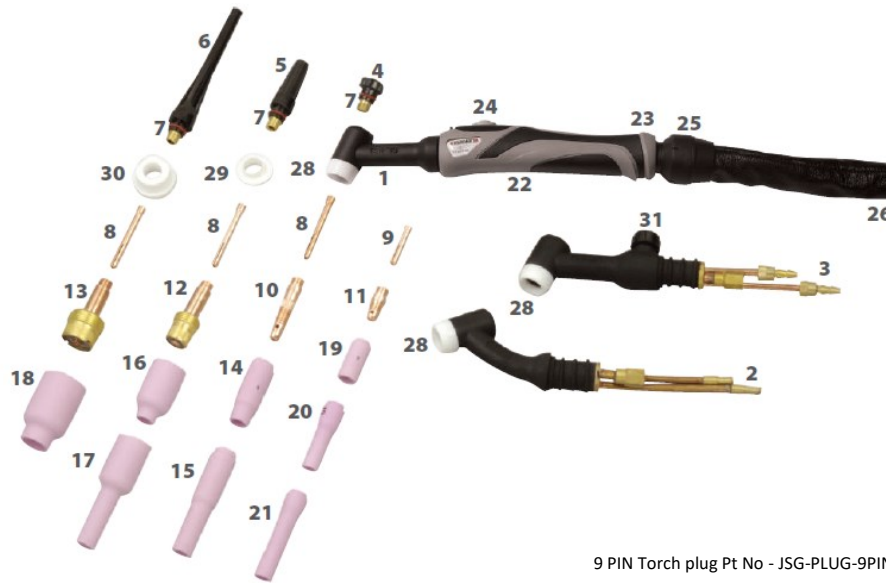

9 PIN Torch plug Pt No - ISG-PLUG-9PIN

Main Consumables

Code	Description	Pack Qty
1	WP18 Rigid Torch Body	1
2	WP18F Flexible Torch Body	1
3	WP18V Torch Body c/w Argon Valve	1
4	57Y04 Short Back Cap	1
5	300M Medium Back Cap	1
6	57Y02 Long Back Cap	1
7	98W18 Back Cap 'O' Ring	10

Collets

8	10N21 Standard .020" (0.5mm)	5
	10N22 Standard .040" (1.0mm)	5
	10N23 Standard 1/16" (1.6mm)	5
	10N26 Standard 5/64" (2.0mm)	5
	10N24 Standard 3/32" (2.4mm)	5
	10N25 Standard 1/8" (3.2mm)	5
	54N20 Standard 5/32" (4.0mm)	5
9	10N21S Stubby .020" (0.5mm)	5
	10N22S Stubby .040" (1.0mm)	5
	10N23S Stubby 1/16" (1.6mm)	5
	10N24S Stubby 3/32" (2.4mm)	5
	10N25S Stubby 1/8" (3.2mm)	5

Collet Bodies

10	10N29 Standard .020" (0.5mm)	5
	10N30 Standard .040" (1.0mm)	5
	10N31 Standard 1/16" (1.6mm)	5
	10N31M Standard 5/64" (2.0mm)	5
	10N32 Standard 3/32" (2.4mm)	5
	10N28 Standard 1/8" (3.2mm)	5
	406488 Standard 5/32" (4.0mm)	5
11	17CB20 Stubby .020"-1/8" (0.5 - 3.2mm)	5

Gas Lens Bodies

12	45V29 Standard .020" (0.5mm)	1
	45V24 Standard .040" (1.0mm)	1
	45V25 Standard 1/16" (1.6mm)	1
	45V25M Standard 5/64" (2.0mm)	1
	45V26 Standard 3/32" (2.4mm)	1
	45V27 Standard 1/8" (3.2mm)	1
	45V28 Standard 5/32" (4.0mm)	1
13	45V0204 Large Dia .020"-.040" (0.5 - 1.0mm)	1
	45V116 Large Dia 1/16" (1.6mm)	1
	45V64 Large Dia 3/32" (2.4mm)	1
	995795 Large Dia 1/8" (3.2mm)	1
	45V63 Large Dia 5/32" (4.0mm)	1

Ceramic Cups

14	10N50 Standard Cup 1/4" Bore	10
	10N49 Standard Cup 5/16" Bore	10
	10N48 Standard Cup 3/8" Bore	10
	10N47 Standard Cup 7/16" Bore	10
	10N46 Standard Cup 1/2" Bore	10
	10N45 Standard Cup 5/8" Bore	10
	10N44 Standard Cup 3/4" Bore	10
15	10N50L Long Cup 1/4" Bore	10
	10N49L Long Cup 5/16" Bore	10
	10N48L Long Cup 3/8" Bore	10
	10N47L Long Cup 7/16" Bore	10

Gas Lens Cups

Code	Description	Pack Qty
16	54N18 Standard Cup 1/4" Bore	10
	54N17 Standard Cup 5/16" Bore	10
	54N16 Standard Cup 3/8" Bore	10
	54N15 Standard Cup 7/16" Bore	10
	54N14 Standard Cup 1/2" Bore	10
	54N19 Standard Cup 11/16" Bore	10
17	54N17L Long Cup 5/16" Bore	10
	54N16L Long Cup 3/8" Bore	10
	54N15L Long Cup 7/16" Bore	10
	54N14L Long Cup 1/2" Bore	10
18	57N75 Large Dia Cup 3/8" Bore	5
	57N74 Large Dia Cup 1/2" Bore	5
	53N88 Large Dia Cup 5/8" Bore	5
	53N87 Large Dia Cup 3/4" Bore	5

Ceramic Cups for use with item 11

19	13N08 Standard Cup 1/4" Bore	10
	13N09 Standard Cup 5/16" Bore	10
	13N10 Standard Cup 3/8" Bore	10
	13N11 Standard Cup 7/16" Bore	10
	13N12 Standard Cup 1/2" Bore	10
	13N13 Standard Cup 5/8" Bore	10
20	796F70 Long Cup 3/16" Bore	10
	796F71 Long Cup 1/4" Bore	10
	796F72 Long Cup 5/16" Bore	10
	796F73 Long Cup 3/8" Bore	10
21	796F74 X - Long Cup 3/16" Bore	10
	796F75 X - Long Cup 1/4" Bore	10
	796F76 X - Long Cup 5/16" Bore	10
	796F77 X - Long Cup 3/8" Bore	10

Secondary Consumables

22	SP9110 LH & RH Handle Shell	1
23	SP9111 Handle Screw	1
24	SP9120 Single Button Switch	1
	SP9121 2 Button Switch	1
	SP9122 5K Potentiometer Switch	1
	SP9123 10K Potentiometer Switch	1
	SP9128 47K Potentiometer Switch	1
	SP9129 4 Button Switch	1
25	SP9114 Handle Ball Joint	1
26	SP9117 Leather Cover 800mm	1
27	SP9119 Cable Cover Joint (not illustrated)	1
28	18CCG Standard Heat Shield	1
29	54N01 Gas Lens Heat Shield	1
30	54N63 Large Gas Lens Insulator	1
31	VS-1 Valve Stem WP18V	1
32	40V64 Power Cable Assy 12.5ft - 3/8" Bsp	1
	41V29 Power Cable Assy 25ft - 3/8" Bsp	1
33	45V07 Argon Hose Assy 12.5ft - 3/8" Bsp	1
	45V08 Argon Hose Assy 25ft - 3/8" Bsp	1
34	40V74 Water Hose Assy 12.5ft - 3/8" Bsp	1
	41V32 Water Hose Assy 25ft - 3/8" Bsp	1
35	0315071 Insulation Boot	5
36	6091 Neoprene Protective Cover	1m
37	SP9126 4m Switch Cable c/w 5 Pin Receptacle	1
	SP9127 8m Switch Cable c/w 5 Pin Receptacle	1

TIG WELDING PROBLEMS



Before starting any welding activity ensure that you have suitable eye protection and protective clothing. Also take the necessary steps to protect any persons within the welding area.

TIG welding defects and prevention methods

<u>Defect</u>	<u>Possible cause</u>	<u>Action</u>
Excessive tungsten use	Set up for DCEP	Change to DCEN
	Insufficient shield gas flow	Check for gas restriction and correct flow rates. Check for drafts in the weld area.
	Electrode size too small	Select correct size
	Electrode contamination during cooling time	Extend post flow gas time
Porosity/weld contamination	Loose torch or hose fitting	Check and tighten all fitting
	Inadequate shield gas flow	Adjust flow rate - normally 8-12L/m
	Incorrect shield gas	Use correct shield gas
	Gas hose damaged	Check and repair any damaged hoses
	Base material contaminated	Clean material properly
	Incorrect filler material	Check correct filler wire for grade of use
No operation when torch switch is operated	Torch switch or cable faulty	Check the torch switch continuity and repair or replace as required
	ON/OFF switch turned off	Check position of ON/OFF switch
	Mains fuses blown	Check fuses and replace as required
	Fault inside the machine	Call for a repair technician
Low output current	Loose or defective work clamp	Tighten/replace clamp
	Loose cable plug	Check and tighten all plugs
	Power source faulty	Call a repair technician
High frequency will not strike the arc	Weld/power cable open circuit	Check all cables and connections for continuity, especially the torch cables
	No shield gas flowing	Check cylinder contents, regulator and valves, also check the power source
Unstable arc when welding in DC	Tungsten contaminated	Break off contaminated end and regrind the tungsten
	Arc length incorrect	Arc length should be between 3-6mm
	Material contaminated	Clean all base and filler material
	Electrode connected to the wrong polarity	Reconnect to correct polarity
Arc is difficult to start	Incorrect tungsten type	Check and fit correct tungsten
	Incorrect shield gas	Use argon shield gas

TIG WELDING PROBLEMS



Before starting any welding activity ensure that you have suitable eye protection and protective clothing. Also take the necessary steps to protect any persons within the welding area.

TIG welding defects and prevention methods

<u>Defect</u>	<u>Possible cause</u>	<u>Action</u>
Excessive bead build up, poor penetration or poor fusion at the edges of the weld	Weld current too low	Increase the welding amperage Poor material prep
Weld bead flat and too wide or undercut at the weld edge or burning through	Weld current too high	Decrease the welding amperage
Weld bead too small or insufficient penetration	Welding travel speed too fast	Reduce your welding travel speed
Weld bead too wide or excessive bead build up	Welding travel speed too slow	Increase your welding travel speed
Uneven leg length in fillet joint	Wrong placement of filler rod	Re-position filler rod
Tungsten melts or oxidises when welding arc is made	TIG torch lead connected to + Little or no gas flow to weld pool Gas cylinder or hoses contain impurities The tungsten is too small for the weld current TIG/MMA selector set to MMA	Connect to - polarity Check gas apparatus as well as torch and hoses for breaks or restrictions Change gas cylinder and blow out torch and gas hoses Increase the size of the tungsten Ensure you have the power source set to TIG function

MAINTENANCE



The following operation requires sufficient professional knowledge on electric aspects and comprehensive safety knowledge. Make sure the input cable of the machine is disconnected from the electricity supply and wait for 5 minutes before removing the machine covers.

In order to guarantee that the arc welding machine works efficiently and in safety, it must be maintained regularly. Operators should understand the maintenance methods and means of arc welding machine operation. This guide should enable customers to carry out simple examination and safeguarding by oneself, try to reduce the fault rate and repair times of the arc welding machine, so as to lengthen service life of the arc welding machine.

Period

Maintenance item

Daily examination	<ul style="list-style-type: none"> • Check the condition of the machine, mains cables, welding cables and connections. • Check for any warnings LEDs and machine operation.
Monthly examination	<ul style="list-style-type: none"> • Disconnect from the mains supply and wait for at least 5 minutes before removing the cover. • Check internal connections and tighten if required. • Clean the inside of the machine with a soft brush and vacuum cleaner. • Take care not to remove any cables or cause damage to components. • Ensure that ventilation grills are clear. • Carefully replace the covers and test the unit. <p>This work should be carried out by a suitably qualified competent person.</p>
Yearly examination	<ul style="list-style-type: none"> • Carry out an annual service to include safety check in accordance with the manufacturers standard (EN 60974-1). <p>This work should be carried out by a suitably qualified competent person.</p>

⇒ Ensure the power is disconnected before working on the machine.

⇒ Always wait 5 minutes after power switch off before opening the case.

SERVICE SCHEDULE RECORD

Date	Type of service and work carried out	Serviced by	Due date for next check

TROUBLESHOOTING



The following operation requires sufficient professional knowledge on electric aspects and comprehensive safety knowledge. Make sure the input cable of the machine is disconnected from the electricity supply and wait for 5 minutes before removing the machine covers.

Before arc welding machines are dispatched from the factory, they have already been checked thoroughly. The machine should not be tampered with or altered. Maintenance must be carried out carefully. If any wire becomes loose or is misplaced, it maybe potentially dangerous to the user!

Only professional maintenance personnel should repair the machine!

Ensure the power is disconnected before working on the machine. Always wait 5 minutes after power switch off before removing the panels.

Description of fault	Possible cause
The power LED is OFF and the fan is not functioning	The primary supply voltage has not been switched ON or input fuse has blown
	The welding power source input switch is switched OFF
	Loose connections internally
The fault LED is ON and the fan is running	The machine is under over-heating protection status and will recover automatically after the welding machine has cooled down
	Check incoming mains supply to ensure it is within 230V +/- 15%
No high frequency is produced	Process selection switch is set to manual metal arc (MMA)
	Torch trigger switch lead is disconnected or switch/lead is faulty
	High frequency spark gap too wide or short circuited
Welding current reduces when welding	Poor work lead connection to the work piece
TIG electrode melts when arc is struck	TIG torch is connected to the (+) VE terminal
No gas flow when the TIG torch trigger switch is depressed	Empty gas cylinder
	Gas regulator is turned off
	Gas hose is blocked or cut
	Torch trigger switch lead is disconnected or switch/lead is faulty
Difficult to ignite the arc	The arc ignition current is too low or the arc ignition time is too short
The electrode holder becomes very hot	The rated current of the electrode holder is smaller than its actual working current, replace it with a higher rated current capacity
Excessive spatter in MMA welding	The output polarity connection is incorrect, exchange the polarity
Other malfunction	Contact your supplier

TROUBLESHOOTING - ERROR CODES



The following operation requires sufficient professional knowledge on electric aspects and comprehensive safety knowledge. Make sure the input cable of the machine is disconnected from the electricity supply and wait for 5 minutes before removing the machine covers.

Maintenance must be carried out carefully. If any wire becomes loose or is misplaced, it maybe potentially dangerous to the user!

Only professional maintenance personnel should maintain or repair the machine!

Ensure the power is disconnected before working on the machine. Always wait 5 minutes after power switch off before removing the panels.

Error Code	Category	Symptom	Causes	User Measures
E10	Overcurrent	Permanently turns off the main circuit	Current-sensing circuit is damaged or overcurrent protection of main power components is triggered	Please power off the machine and restart it. If the failure cannot be solved, contact the service department for assistance
E34	Undervoltage	Permanently turns off the main circuit	Auxiliary power supply is abnormal	Please power off the machine and check if the auxiliary power supply cable is connected properly. If the problem cannot be solved, contact the service department for assistance
E60	Overheated	Temporarily turns off the main circuit	The main circuit has been working for too long to the extent that exceeds its duty cycle	Do not power off the machine. Wait until the main circuit cools down and then resume the welding
E30	Overtoltage/ undervoltage/ phase loss	Permanently turns off the main circuit	Phase loss may be caused by phase loss of the input power supply. The voltage of input power supply is not within the specified voltage range. The input power is not sufficient	Please check if normal input power supply
E71	Lack of water supply	Temporarily turns off the main circuit	There is insufficient coolant in the tank. The coolant path is blocked.	Check if the coolant level in the tank is within the required range. Check the coolant path for blockages, kinks etc..
E13	Current feedback is abnormal	Permanently turns off the main circuit	The current feedback line has a poor connection. The processing circuit for current feedback is abnormal or the hall current sensor doesn't work normally	Please power off the machine and check the connection of the current feedback line. Contact the service department for assistance
E33	Voltage feedback is abnormal	Permanently turns off the main circuit	The voltage feedback line has a poor connection. The processing circuit for voltage feedback is abnormal	Please power off the machine and check the connection of the voltage feedback line. Contact the service department for assistance

WEEE disposal

The equipment is manufactured with materials which do not contain any toxic or poisonous materials dangerous to the operator.

When the equipment is scrapped, it should be dismantled separating components according to the type of materials.

Do not dispose of the equipment with normal waste. The European Directive 2002/96/EC and United Kingdom's Directive The Waste Electrical and Electronic Equipment (WEEE) regulations 2013 states that electrical equipment that has reached its end of life must be collected separately and returned to an environmentally compatible recycling facility.

Jasic has a relevant recycling system which is compliant and registered in the UK with the environment agency. Our registration reference is WEEMM3813AA.

In order to comply with WEEE regulations outside the UK you should contact your supplier.

RoHS Compliance Declaration

We herewith confirm, that the above mentioned product does not contain any of the restricted substances as listed in EU Directive 2011/65/EU and the UK directive ROHS Regulations 2012 in concentrations above the limits as specified therein.

UKCA Declaration of Conformity

The manufacturer, or its legal representative Wilkinson Star Limited, declares that the equipment described below is designed and produced according to following UK legislation:

- Electrical equipment safety 2016
- Electromagnetic compatibility (EMC) regulations 2016
- The restrictions of the use of certain hazardous substances in electrical and electronic equipment regulations 2012

And inspected according to following designated standards:

- EN 60 974-1:2018+A1:2019
- EN 60 974-10:2014+A1:2015

Any alteration or change to these machines by any unauthorized person makes this declaration invalid.

Model:

JT-300P

Authorised Representative:

Wilkinson Star Limited
Shield Drive
Wardley Industrial Estate
Worsley
Manchester
M28 2WD

Disclaimer:

Please note that this confirmation is given to the best of our present knowledge and belief. Nothing herein represents and/or may be interpreted as warranty within the meaning of the applicable warranty law.

EC Declaration of Conformity

EC DECLARATION OF CONFORMITY

The manufacturer, or its legal representative **Wilkinson Star Limited**, declares that the equipment described below is designed and produced according to following EU Directives:

- Low Voltage Directive (LVD), No.: 2014/35/EU
- Electromagnetic compatibility (EMC) Directive, No.: 2014/30/EU

And inspected according to following

EU - Norms:

- EN 60 974-1:2012
- EN 60 974-10:2014+A1

Any alteration or change to these machines by any unauthorized person makes this Declaration invalid.

Wilkinson Star model
JT-300P

Jasic Model
TIG 300P (W232)

Authorised Representative

Wilkinson Star Limited
Shield Drive, Wardley Industrial Estate,
Worsley, Manchester M28 2WD
Tel 0161 793 8127

Manufacturer

Shenzhen Jasic Technology Co LTD
No3 Qinglan, 1st Road
Pingshan District
Shenzhen, China

Signature

Dr John A Wilkinson QBE

Position (Chairman)

Signature

Shenzhen Jasic Technology Co LTD

Position

Date



Company stamp

Date



Company stamp

STATEMENT OF WARRANTY

All new JASIC welders, plasma cutters and multi-process units sold through our partner Wilkinson Star Limited within the United Kingdom and Ireland shall be warranted to the original owner, non transferable, against failure due to defective materials or production. The warranty period is 5 years following the date of purchase. We recommend you register your product within 28 days of purchase. The original invoice is documentation for the standard warranty period. The warranty period is based on a single shift pattern.

Defective units shall be repaired or replaced by the company at our workshop. The company may opt to refund the purchase price (less any costs and depreciation due to use and wear). The company reserves the right to alter the warranty conditions at any time with effect for the future.

A prerequisite for the full warranty is that products are operated in accordance with the operating instructions supplied, observing the relevant installation and any legal requirements recommendations and guidelines and carrying out the maintenance instructions shown in the operator manual. This should be carried out by a suitably qualified competent person.

In the unlikely event of a problem, this should be reported to Jasic technical support team to review the claim.

The customer has no claim to loan or replacement products whilst repairs are being performed.

The following falls outside the scope of the warranty:

- Defects due to natural wear and tear
- Failure to observe the operating and maintenance instructions
- Connection to an incorrect or faulty mains supply
- Overloading during use
- Any modifications that are made to the product without the prior written consent
- Software errors due incorrect operation
- Any repairs that are carried out using non-approved spare parts
- Any transport or storage damage
- Direct or indirect damage as well as any loss of earnings are not covered under the warranty
- External damage such as fire or damage due to natural causes e.g. flooding

NOTE: Under the terms of the warranty, welding torches, their consumable parts, wire feed unit drive rolls and guide tubes, work return cables and clamps, electrode holders, connection and extension cables, mains and control leads, plugs, wheels, coolant etc. are covered with a 3 month warranty.

Jasic shall in no event be responsible for any third party expenses or expenses/costs or any indirect or consequential expenses/costs.

Jasic will submit an invoice for any repair work performed outside the scope of the warranty. A quotation for any non warranty will be raised prior to any repairs being carried out.

The decision about repair or replacement of the defective part(s) is made by Jasic. The replaced part(s) remain(s) Jasic property.

Warranty extends only to the machine, its accessories and parts contained inside. No other warranty is expressed or implied. No warranty is expressed or implied in regards to the fitness of the product for any particular application or use.

For further information on Jasic product warranty terms and product warranty registration please visit:

www.jasic-warranty.co.uk/terms

www.jasic-warranty.co.uk

OPTIONS AND ACCESSORIES

Part Number	Description
TIG torch options for JT-300P water cooled package	
TIG-83ERGO	Titanium 18 TIG Torch 12.5ft c/w Adaptor + Jasic Plug
TIG-83ERGO-FLEXI	Titanium 18 Flexi TIG Torch 12.5ft c/w Adaptor + Jasic Plug
TIG-83-8MERGO	Titanium 18 TIG Torch 25ft c/w Swivel Dinse + Jasic Plug
TIG-83F-8MERGO	Titanium 18F TIG Torch 25ft c/w Swivel Dinse + Jasic Plug
TIG-83-8MERGO10K	Titanium 18 TIG Torch 25ft c/w Swivel Dinse with 10K Potentiometer + Jasic Plug
TIG torch options for JT-300P air cooled package	
TIG-79ERGO	WP26 TIG Torch 12.5ft c/w Dinse Adaptor + Jasic Plug
TIG-79ERGO-FLEXI	WP26F TIG Torch 12.5ft c/w Dinse Adaptor + Jasic Plug
TIG-79ERGO-8M	WP26 TIG Torch 25ft c/w Dinse Adaptor + Jasic Plug
TIG-79ERGO-8MFLEXI	WP26F TIG Torch 12.5ft c/w Dinse Adaptor + Jasic Plug
Part Number	Description
JFC-08	Jasic Remote Control Foot Pedal
JSG-PLUG-9PIN	TIG Torch Switch Plug (9 Pin)
JSG-PLUG-9PIN	Foot Pedal Plug (9 Pin)
WCS50-5	Welding Cable Set (MMA) 5m (50mm Cable)
WC-5-05	Electrode Holder and Lead 5m
EC-2-03LD	Work Return Lead and Clamp 5m
CP5070	Cable Plug 50-70mm
SSARG1GPS	Single Stage 1 Gauge Argon Pre Set Regulator
FLOW14	0-14LPM Flowmeter
JH-HDX	Jasic HD True Colour Auto Darkening Welding Helmet
SSARG2G	Single Stage 2 Gauge Argon Regulator



JFC-08
Jasic Remote Foot Control



JH-HDX
Jasic Auto Darkening HD
Welding Helmet
with True Colour Technology

Wilkinson Star Limited

Shield Drive

Wardley Industrial Estate

Worsley

Manchester

UK

M28 2WD

+44 (0)161 793 8127



www.jasic.co.uk

November 2020 - Issue 10