

Mobile Filter Units

FilterMaster XL

Art. No.: 62 100 100



Technical Data

Filter	
Filter stages	1
Filter method	Cleanable filter
Filter cleaning method	Rotating nozzle
Filter surface	10 m ²
Type of filter	Filter cartridge
Filter material	ePTFE membrane
Filter efficiency	> 99.9 %
Dust classification	M
Basic data	
Extraction capacity	1000 m ³ /h
Dimensions (w x t x h)	643 x 816 x 1457 mm
Weight	155 kg
Motor power	1.5 kW
Power supply	3 x 400 V / 50 Hz
Rated current	3.2 A
Noise level	69 dB(A)
Additional information	
IFA-Certification	W3-Approved
Fan type	Radial fan
Compressed air supply	5 - 6 bar
Quantity of extraction arms	1
Exhaust arm type	flexible exhaust arm
Diameter extraction arm	150 mm
Length of exhaust arm	2 m

Applications

- Suitable for all materials, including high-alloy steel
- High levels of smoke and particles
- Non-stop operation

Benefits

- High efficiency due to automatic filter cleaning
- Exhaust arm requires less adjustment due to flow-optimised exhaust hood design
- Best health protection for employees by use of KemTex® ePTFE filter cartridge with surface filtration
- Safe operation by rotation field control

Properties

- 360 degrees rotating exhaust hood with damper
- W3/IFA certified
- Automatic filter cleaning
- KemTex® ePTFE filter cartridge
- Rotation field control
- Exhaust arm up to 4 m
- Rotating exhaust hood



Suitable for alveole exchangeable dusts
separation > 99 % of particles < 0,4 µm

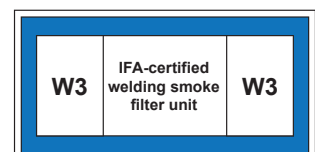

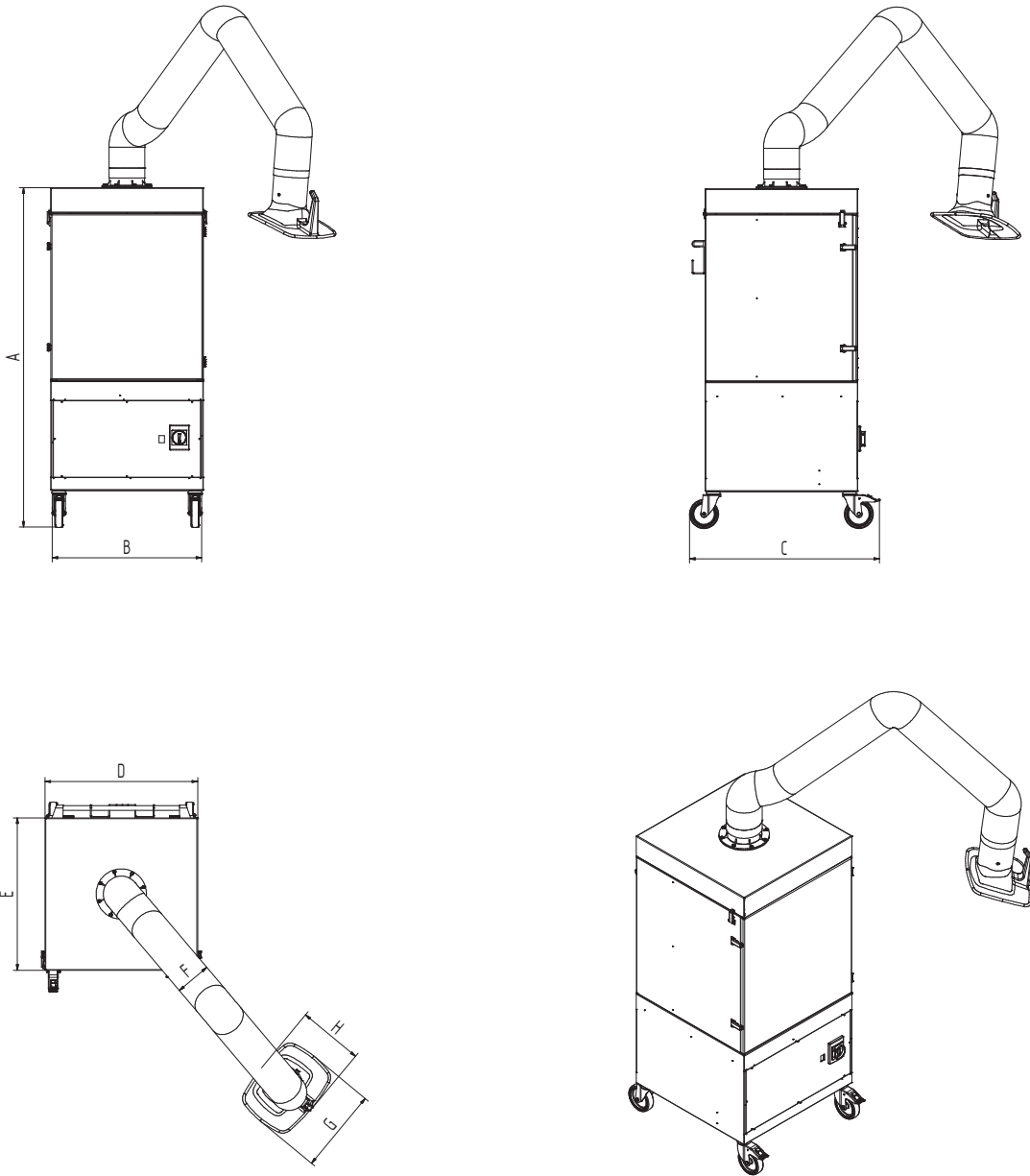

Technical Data

Dimensions

A	1457 mm
B	643 mm
C	816 mm
D	655 mm
E	655 mm
F	150 mm
G	360 mm
H	295 mm