

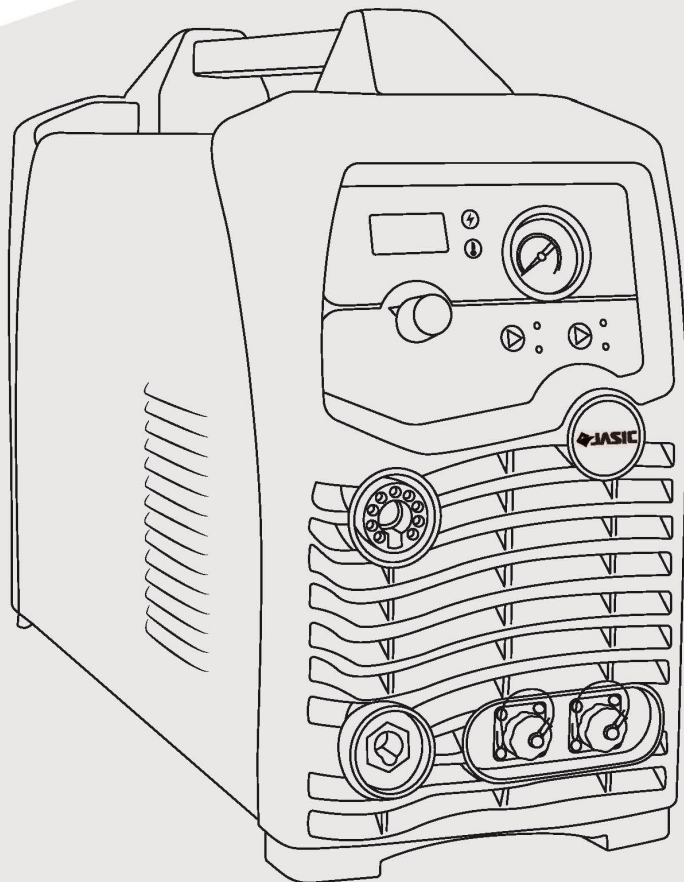

Plasma Cut Series

Plasma Cut 80 (JP-81)



Operator Manual



Intertek

CE

UK
CA



Your new product

Thank you for selecting this Jasic product.

This product manual has been designed to ensure that you get the most from your new product. Please ensure that you are fully conversant with the information provided paying particular attention to the safety precautions. The information will help protect yourself and others against the potential hazards that you may come across.

Please ensure that you carry out daily and periodic maintenance checks to ensure years of reliable and trouble free operation.

Please call your Jasic distributor in the unlikely event of a problem occurring. Please record below the details from your product as these will be required for warranty purposes and to ensure you get the correct information should you require assistance or spare parts.

Date purchased _____

From where _____

Serial number _____

(The serial number is normally located on the top or underside of the machine and will begin with AA).

For further information on your Jasic product warranty registration please visit:

www.jasic-warranty.co.uk

Disclaimer

Whilst every effort has been made to ensure that the information contained within this manual is complete and accurate, no liability can be accepted for any errors or omissions.

Please note:

Products are subject to continual development and may be subject to change without notice.

Regularly check our product pages at www.Jasic.co.uk for revision updated operating manuals.

No part of this manual may be copied or reproduced by any means without the written permission of Wilkinson Star Limited.

CONTENTS

Index	Page
Your New Product	2
Index	3
Safety Instruction	4
General electrical safety	4
General operating safety	4
PPE	5
Welding processes lens shade selector guide	5
Fume and welding gases	6
Fire risks	6
The working environment	7
Protection from moving parts	7
Magnetic fields	7
Compressed gas cylinders and regulators	7
RF declaration	8
LF declaration	8
Materials and their disposal	8
Product Overview	9
Product details and application	10
Technical Specifications	11
Description of Controls	12
Remote Control Connection	14
Installation	15
What is Plasma?	17
Operation	18
Cut Quality	20
Typical Cutting Speeds	21
General Cutting Information	22
Plasma Hand Torch PT60 Information	23
Plasma Machine Torch TM125 Information	26
Maintenance	27
Troubleshooting	28
Plasma Cutting Problems	29
WEEE Disposal	31
RoHS Compliance Declaration	31
UKCA Declaration of Conformity	31
EC Declaration of Conformity	32
Statement of Warranty	33
Notes	34
Jasic Contact Details	36

SAFETY INSTRUCTIONS

These general safety norms cover both arc welding machines and plasma cutting machines unless otherwise noted.

It is important that users of this equipment protect themselves and others from harm or even death. The equipment must only be used for the purpose it was designed for. Using it in any other way could result in damage or injury and in breach of the safety rules.

Only suitably trained and competent persons should use the equipment.

Pacemaker wearers should consult their doctor prior to using this equipment.

PPE and workplace safety equipment must be compatible for the application of the work involved.

Always carry out a risk assessment before undertaking any welding or cutting activity

General electrical safety



The equipment should be installed by a qualified person and in accordance with current local electrical safety standards. It is the users responsibility to ensure that the equipment is connected to a suitable power supply. Consult with your utility supplier if required.

Do not use the equipment with the covers removed.

Do not touch live electrical parts or parts which are electrically charged.

Turn off all equipment when not in use.

In the case of abnormal behaviour of the equipment, the equipment should be checked by a suitably qualified service engineer.

If earth bonding of the work piece is required, bond it directly with a separate cable with a current carrying capacity capable of carrying the maximum capacity of the machine current.

Cables (both primary supply and welding) should be regularly checked for damage and overheating.

Never use worn, damaged, under sized or poorly jointed cables.

Insulate yourself from work and earth using dry insulating mats or covers big enough to prevent any physical contact.

Never touch the electrode if you are in contact with the work piece return.

Do not wrap cables over your body.

Ensure that you take additional safety precautions when you are welding in electrically hazardous conditions such as damp environments, wearing wet clothing and metal structures.

Try to avoid welding in cramped or restricted positions.

Ensure that the equipment is well maintained. Repair or replace damaged or defective parts immediately.

Carry out any regular maintenance in accordance with the manufacturers instructions.

The EMC classification of this product is class A in accordance with electromagnetic compatibility standards CISPR 11 and IEC 60974-10 and therefore the product is designed to be used in industrial environments only.

WARNING: This class A equipment is not intended for use in residential locations where the electrical power is provided by a public low-voltage supply system. In those locations it may be difficult to ensure the electromagnetic compatibility due to conducted and radiated disturbances.

General operating safety

Never carry the equipment or suspend it by the carrying strap or handles during welding.

Never pull or lift the machine by the welding torch or other cables. Always use the correct lift points or handles. Always use the transport under gear as recommended by the manufacturer.

Never lift a machine with the gas cylinder mounted on it.

If the operating environment is classified as dangerous, only use S-marked welding equipment with a safe idle voltage level. Such environments may be for example: humid, hot or restricted accessibility spaces.

SAFETY INSTRUCTION

Use of Personal Protective Equipment (PPE)

Welding arc rays from all welding processes produce intense, visible and invisible (ultraviolet and infrared) rays that can burn eyes and skin.

- Wear an approved welding helmet fitted with an appropriate shade of filter lens to protect your face and eyes when welding or watching.
- Wear approved safety glasses with side shields under your helmet.
- Never use broken or faulty welding helmets.
- Always ensure there are adequate protective screens or barriers to protect others from flash, glare and sparks from the welding area.
- Ensure that there are adequate warnings that welding or cutting is taking place.
- Wear suitable protective flame resistant clothing, gloves and footwear.
- Check and be sure the area is safe and clear of inflammable material before carrying out any welding.



Some welding and cutting operations may produce noise. Wear safety ear protection to protect your hearing if the ambient noise level exceeds the local allowable limit (e.g: 85 dB).

Welding and Cutting Lens Shade Selector Guide

CURRENT	MMA ELECTRODES	MIG LIGHT ALLOYS	MIG HEAVY METALS	MAG	TIG ON ALL METALS	PLASMA CUTTING	PLASMA WELDING	GOUGING ARC/AIR
10	8							
15					9		10	
20								
30	9	10	10	10	10		11	
40								
60	10					11		10
80								
100				11			12	
125	11	11	11					
150						12		
175								
200							13	11
225		12			13	12		
250	12	13	12	13				12
275								
300								13
350								
400	13	14	13	14	14	13	14	14
450								
500	14	15	14	15				15

SAFETY INSTRUCTIONS

Safety against fumes and welding gases



Warning
Fumes and
Gases

The HSE have identified welders as being an 'at risk' group for occupational diseases arising from exposure to dusts, gases, vapours and welding fumes. The main identified health effects are pneumonia, asthma, chronic obstructive pulmonary disease (COPD), lung and kidney cancer, metal fume fever (MFF) and lung function changes.

During welding and hot cutting 'hot work' operations, fumes are produced which are collectively known as welding fume. Depending upon the type of welding process being performed, the resultant fume generated is a complex and highly variable mixture of gases and particulates.

Regardless of the length of welding being carried out, all welding fume, including mild steel welding, requires suitable engineering controls to be in place which is usually Local Exhaust Ventilation (LEV) extraction to reduce the exposure to welding fume indoors and, where LEV does not adequately control exposure, it should also be enhanced by using suitable respiratory protective equipment (RPE) to assist with protecting against residual fume.

When welding outdoors appropriate RPE should be used.

Prior to undertaking any welding tasks an appropriate risk assessment should be carried out to ensure expected control measures are in place.

Locate the equipment in a well-ventilated position and keep your head out of the welding fume.

Do not breathe the welding fume.

Ensure the welding zone is well-ventilated and provision should be made for suitable local fume extraction system to be in place.

If ventilation is poor, wear an approved airfed welding helmet or respirator.

Read and understand the Material Safety Data Sheets (MSDS's) and the manufacturer's instructions for metals, consumables, coatings, cleaners and de-greasers.

Do not weld in locations near any de-greasing, cleaning or spraying operations.

Be aware that heat and rays of the arc can react with vapours to form highly toxic and irritating gases.

For further information please refer to the HSE website www.hse.gov.uk for related documentation.

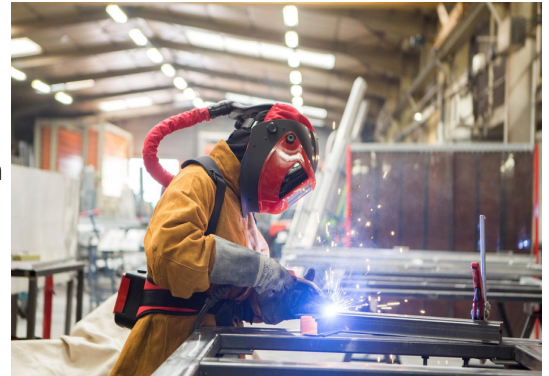

An example of personal fume protection

Precautions against fire and explosion



Warning
Fire Risk

Avoid causing fires due to sparks and hot waste or molten metal.

Ensure that appropriate fire safety devices are available near the welding and cutting area.

Remove all flammable and combustible materials from the welding, cutting and surrounding areas.

Do not weld or cut fuel and lubricant containers, even if empty. These must be carefully cleaned before they can be welded or cut.

Always allow the welded or cut material to cool before touching it or placing it in contact with combustible or flammable material.

Do not work in atmospheres with high concentrations of combustible fumes, flammable gases and dust.

Always check the work area half an hour after cutting to make sure that no fires have begun.

Take care to avoid accidental contact of electrode to metal objects. This could cause arcs, explosion, overheating or fire.



Understand your fire extinguishers

SAFETY INSTRUCTIONS

The working environment

Ensure the machine is mounted in a safe and stable position allowing for cooling air circulation.

Do not operate equipment in an environment outside the laid down operating parameters.

The welding power source is not suitable for use in rain or snow.

Always store the machine in a clean, dry space.

Ensure the equipment is kept clean from dust build up.

Always use the machine in an upright position.

Protection from moving parts

When the machine is in operation keep away from moving parts such as motors and fans.

Moving parts, such as the fan, may cut fingers and hands and snag garments.

Protections and coverings may be removed for maintenance and controls only by qualified personnel after first disconnecting the power supply cable.

Replace the coverings and protections and close all doors when the intervention is finished and before starting the equipment.

Take care to avoid getting fingers trapped when loading and feeding wire during set up and operation.

When feeding wire be careful to avoid pointing it at other people or towards your body.

Always ensure machine covers and protective devices are in operation.

Risks due to magnetic fields



The magnetic fields created by high currents may affect the operation of pacemakers or electronically controlled medical equipment.

Wearers of vital electronic equipment should consult their physician before beginning any arc welding, cutting, gouging or spot welding operations.

Do not go near welding equipment with any sensitive electronic equipment as the magnetic fields may cause damage.

Keep the torch cable and work return cable as close to each other as possible throughout their length.

This can help minimise your exposure to harmful magnetic fields.

Do not wrap the cables around the body.

Handling of compressed gas cylinders and regulators

Mishandling gas cylinders can lead to rupture and the release of high pressure gas.



Always check the gas cylinder is the correct type for the welding to be carried out.

Always store and use cylinders in an upright and secure position.

All cylinders and pressure regulators used in welding operations should be handled with care.

Never allow the electrode, electrode holder or any other electrically “hot” parts to touch a cylinder.

Keep your head and face away from the cylinder valve outlet when opening the cylinder valve.

Always secure the cylinder safely and never move with regulator and hoses connected.

Use a suitable trolley for moving cylinders.

Regularly check all connections and joints for leaks.

Full and empty cylinders should be stored separately.

Never deface or alter any cylinder

SAFETY INSTRUCTIONS

RF Declaration

Equipment that complies with directive 2014/30/EU concerning electromagnetic compatibility (EMC) and the technical requirements of EN60974-10 is designed for use in industrial buildings and not those for domestic use where electricity is provided via the low voltage public distribution system.

Difficulties may arise in assuring class A electromagnetic compatibility for systems installed in domestic locations due to conducted and radiated emissions.

In the case of electromagnetic problems, it is the responsibility of the user to resolve the situation.

It may be necessary to shield the equipment and fit suitable filters on the mains supply.

LF Declaration

Consult the data plate on the equipment for the power supply requirements.

Due to the elevated absorbance of the primary current from the power supply network, high power systems affect the quality of power provided by the network. Consequently, connection restrictions or maximum impedance requirements permitted by the network at the public network connection point must be applied to these systems.

In this case, the installer or the user is responsible for ensuring the equipment can be connected, consulting the electricity provider if necessary.

Materials and their disposal

Welding equipment is manufactured with BSI published standards meeting CE requirements of materials which do not contain any toxic or poisonous materials dangerous to the operator.

Do not dispose of the equipment with normal waste. The European Directive 2012/19/EU on Waste Electrical and Electronic Equipment states that electrical equipment that has reached its end of life must be collected separately and returned to an environmentally compatible recycling facility for disposal.

For more detailed information please refer to the HSE website www.hse.gov.uk

PRODUCT OVERVIEW

The Jasic plasma cutting inverter range of machines have been designed as integrated portable cutting power supplies incorporating the most advanced IGBT inverter technology in power electronics.



Jasic Cut 81 Product Features:

- Advanced 40khz IGBT inverter for excellent smooth and precise cutting characteristics
- Cutting speed is increased 1.8 times when compared with oxy acetylene cutting
- Advanced non HF plasma arc ignition
- Compact size, lightweight inverter plasma cutting machine
- High efficiency plasma which is ideal for cutting steel, stainless, copper, cast iron and aluminium
- Convenient single carry handle, easy to manoeuvre
- Simple operation
- Inbuilt pressure gauge with adjustable regulator
- LED digital ammeter display for accurate variable current setting
- Simple user interface with variable cutting control
- 2T/4T latch facility
- The Cut 81 offers a clean cut of 25mm and a severance cut of 30mm
- PT100 (6m) plasma cutting hand torch supplied with each package
- Generator friendly
- Inbuilt CNC interface (suitable for most automated cutting tables)
- Optional 'machine' 180° plasma torch is available

PRODUCT DETAILS AND APPLICATION

Advanced digital control mode

The Jasic plasma cutting machines JP-81 incorporate MUC intelligent digital control technology, and all its major functions are performed using software controls. The digital control plasma cutting machine offers many improvements in function and performance when compared with the traditional type plasma cutting machines.

With PWM technology and high power component IGBTs, it inverts the DC voltage, which is rectified from 50Hz/60Hz input AC voltage, to 30K~50kHz AC high voltage. The voltage is dropped and rectified to output the DC power supply for cutting. This inverter technology provides a machine which is smaller and much less weight than the traditional style machine. The technology provides a high efficiency unit and a switching frequency which is outside the audible range.

Good consistency and stable performance

In traditional machines consistency and performance is often governed by the tolerances of the components used in manufacture and environmental such as temperature and humidity. In some cases the same machine brand and type can vary in performance due to tolerance differences. One of the characteristics of digital control is that it is not sensitive to the change of these parameters. The performance of cutting machine will not be affected by the change of the parameters of individual parts. Therefore, the consistency and stability of performance of the digital control cutter is better than that of traditional cutter.

Powerful cutting performance

The Jasic 81 plasma machine provide economical cutting of metals using compressed air as the plasma gas source. The cutting speed is 1.8 times when compared with oxy acetylene cutting. These machines can cut steel, stainless steel, copper, cast iron and aluminium easily and quickly. The arc is an easy to ignite arc and uses a non HF arc ignition mode. There is a post-flow function operates to cool the torch after cutting. The simple operation and high cutting speed, smooth cutting surface make the plasma process and excellent cutting method.

Product features

The Cut 81 cutting current can be accurately preset with seamless adjustment which is achieved through the preset current function. Thus, the machine can be used to cut work pieces of different thicknesses.

Low current is used when cutting thin plate and high current is used when cutting thick plate to ensure good cutting quality and energy savings.

With protection function of over/under-voltage, thermal overheating and low gas pressure inside the machine; gas-check and 2T/4T function.

Also as standard is the automated interface with remote start/stop, arc established ok to move signal and a divided arc voltage output for a torch height controller making it suitable to connect to most CNC cutting tables when fitted with a 180° cutting torch.

Application

The non HF pilot arc of the Cut 81 combined with the PT100 plasma torch offers excellent arc ignition which can cut through rusty and painted metals along with ferrous and non ferrous easily which can effectively prolong the lifespan of the electrode and nozzle of the plasma cutting torch.

It can be widely used in various industries involving metal cutting such as boiler and pressure vessel manufacturing, chemical container manufacturing, power plant installation and construction industry, metallurgy, chemical engineering, aerospace, automobile and engineering vehicles manufacturing and construction etc.

TECHNICAL SPECIFICATIONS

Parameter	Unit	Jasic Cut 81
Rated input voltage	V	3PH 400V AC \pm 15% 50/60Hz
Rated input power	kVA	15.8
Rated input current I _{max}	A	22
Rated input current I _{eff}	A	14
Cutting current range	A	20 ~ 80
Rated output voltage	V	112
Rated duty cycle	%	80A @ 40% (40°C)
Clean cut	mm	25
Severance cut	mm	30
Pierce cut	mm	20
Minimum air pressure	-	5 Bar (73psi)
Minimum gas flow	-	7.1CFM (200 Ltr/min)
Efficiency	%	85
Power factor	cos ϕ	0.99
Plasma torch	-	6m PT100
CNC Connection Option	-	Yes (standard)
Standard	-	EN60974-1
Protection class	IP	IP21S
Insulation class	-	F
Arc ignition	-	Non HF
Noise	Db	<110
Operating temperature	°C	-10 ~ +40
Storage temperature	°C	-25 ~ +55
Overall size	mm	555 x 210 x 415
Weight	Kg	15
Circle cutting guide kit	-	Part number 51864

Please Note

Due to variations in manufactured products all claimed performance ratings, capacities, measurements, dimensions and weights quoted are approximate only. Achievable performance and ratings when in use can depend upon correct installation, applications and use along with regular maintenance and service.

CONTROLS

Front view Jasic Cut 81

1. Digital ammeter: Displays the preset and actual current when cutting
2. Power indicator: Will be lit when the machine is switched on
3. Temperature indicator, when this LED is on it indicates that the temperature inside the machine is too high and the machine is under over heating protection status. Allow machine to cool down
4. Pressure gauge: Displays set air pressure
5. Current control: Allows the user to set the required current demand
6. 2T/4T torch trigger latch selection switch: A useful function when carrying out longer cuts, when cutting in 4T mode you can remove your finger off the torch trigger and the arc will remain on until you either press the torch trigger again or you remove the plasma arc away from the material being cut (see page 22 for further information)
7. Gas test switch: Gas test indicator and cutting indicator
8. Torch connector: Socket used to connect the plasma torch (see page 16 for fitting instructions)
9. Work return connector (35/50mm Socket)
10. Remote start/stop and OK to move signal (see page 14 for further information)
11. Arc voltage feedback signal (see page 14 for further information)

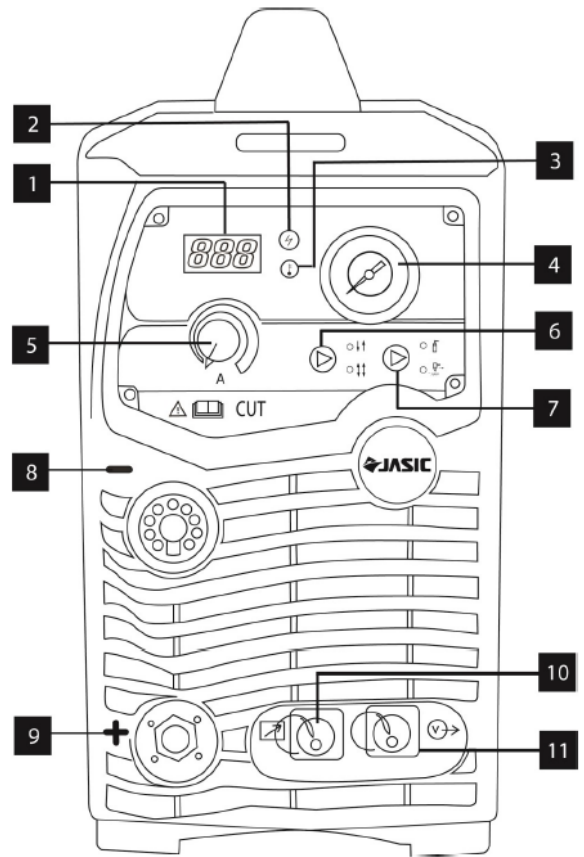

Rear view Jasic Cut 81

12. Air supply inlet
13. Input power cable
14. Mains ON/OFF switch

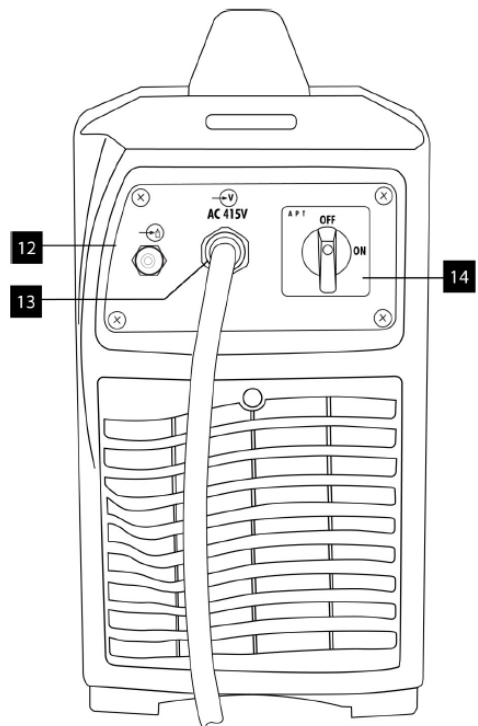

CONTROLS

Control panel view Jasic Cut 81

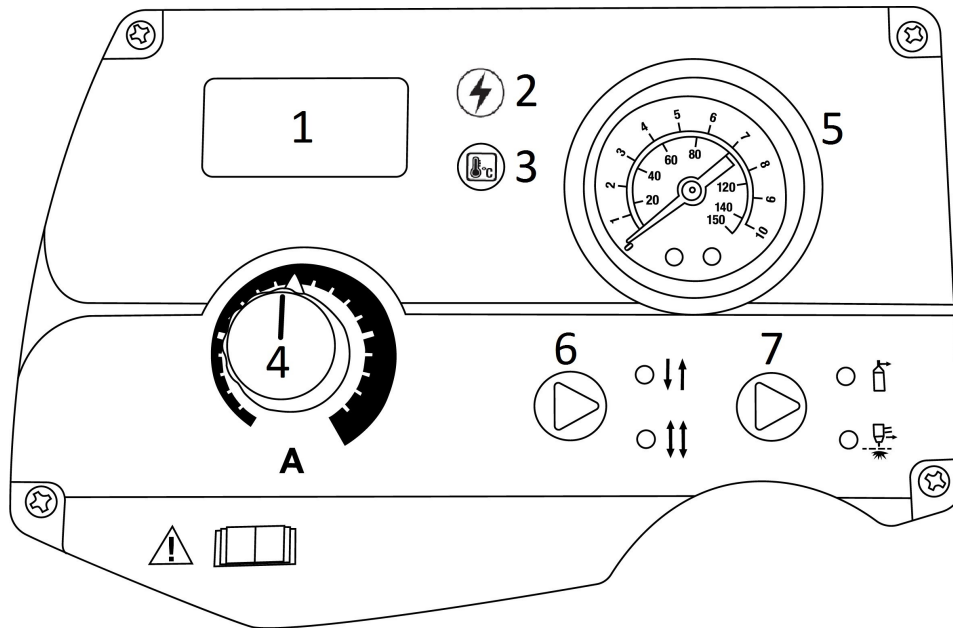

Number	Symbol	Function
1		Digital ammeter which displays the preset and actual current when cutting.
2		Power indicator. When illuminated indicates that the machine is powered on. Once a welding arc has been established this LED will flash.
3		Overheating indicator. Normally off. If this LED is on it indicates that the temperature inside the machine is too high and the machine is under over heating protection status. When lit the machine stops working, then allow the machine to cool down.
4	A	Current control dial, this function allows the user to set the required current demand which is displayed on the digital ammeter.
5	-	Pressure gauge which will display the preset pressure set by the pressure regulator.
6a		2T indicator: It illuminates when the machine is under 2T torch trigger control.
6b		4T indicator: It illuminates when the machine is under 4T (latch) torch trigger control.
7a		Gas-check indicator: It illuminates when the machine is under gas-check status. When lit, the machine cannot cut.
7b		Work Light: When the Cut 81 plasma cutter have gone from piloting to actual cutting this indicator will come on to show that you have transferred and will stay on as long as you are cutting the material.

REMOTE CONTROL CONNECTION

Jasic JP-81 Plasma CNC Connections

2 Pin socket

Pin 1: + Divided Arc Signal output *

Pin 2: - Divided Arc Signal output *

4 Pin Socket

Pin 1: OK to move signal **

Pin 2: OK to move signal **

Pin 3: Remote Start/Stop ***

Pin 4: Remote Start/Stop ***

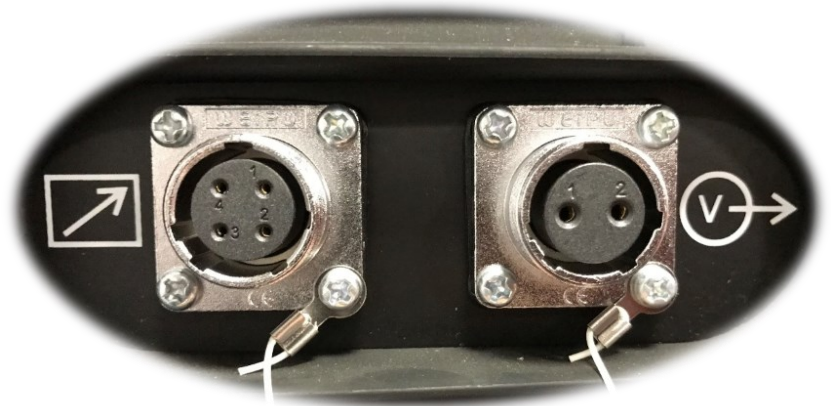

* Pins 1 & 2 – Output, which provides the divided arc signal output for a torch height controller (THC), the factory divided voltage options are 50:1, 30:1 and 20:1

** Pin 1 and 2 – Output, provides the OK to move signal output which is a normally open, dry contact closure when the plasma arc transfers

*** Pins 3 & 4 – Input, which requires a normally open dry contact closure to activate the plasma

Control Plug Part Numbers:

2 Pin Plug Pt No - JSP-02

4 Pin Plug Pt No - 10004659

PRIOR TO A CNC INSTALLATION, ALWAYS CHECK THE DIVIDED ARC SETTING TO ENSURE ITS CORRECTLY SET FOR YOUR INSTALLATION!



The following operation requires sufficient professional knowledge on electric aspects and comprehensive safety knowledge. Make sure the input cable of the machine is disconnected from the electricity supply and wait for 5 minutes before removing the machine covers.

To set the Jasic Plasma's divided arc voltage to be compatible with a CNC tables Torch Height Controller (THC) you will need to have a technician remove the covers of the JP-81 plasma machines, locate the soldered links on the main PCB and re-solder the link to your torch height controller CNC cutting table requirements.

For further information or assistance please contact your supplier.

INSTALLATION

Unpacking

Check the packaging for any signs of damage.

Carefully remove the machine and retain the packaging until the installation is complete.

Location

The machine should be located in a suitable position and environment. Care should be taken to avoid moisture, dust, steam, oil or corrosive gases.

Place on a secure level surface and ensure that there is adequate clearance around the machine to ensure natural airflow.

Input connection

Before connecting the machine you should ensure that the correct supply is available. Details of the machine requirements can be found on the data plate of the machine or in the technical parameters shown in the manual.

The equipment should be connected by a suitably qualified competent person. Always ensure the equipment has a proper grounding.

Never connect the machine to the mains supply with the panels removed.

Input air connection

- The Jasic Plasma Cut 81 are only designed to be used with compressed air, do not use with oxygen or any other gas and the compressor or air cylinder air requirements are as follows:
 - ◆ Minimum air input: 5 Bar (73psi)
 - ◆ Minimum air flow: 7.1CFM (200Ltr/min)
 - Connect the compressed air with the supplied air hose and air fitting to the machine via the inlet connection on the rear panel (max 8 Bar).
 - The air regulator for the Cut 81 is in-built within the machine and comes delivered preset. To adjust please see page 28.
 - Any water which has been collected by the air regulator will be drained by the auto drain system of the inbuilt air regulator.
- ⇒ Ensure your compressor offers only dry compressed air and is capable of delivering the volume of air that is required to run your plasma cutting machine to specification, we recommend the minimum air supply requirements of 220 Ltr/min @ 5 Bar (73psi).
- ⇒ When using either a compressed air cylinder or a compressor ensure it is equipped with a suitably fitted high pressure regulator capable of reducing the pressure to the required amount.

Output connections

Work return cable

Insert the cable plug of the work return lead into the dinse socket on the front panel of the welding machine and tighten it clockwise.

Please Note:

Check these power connections daily to ensure they have not become loose otherwise arcing may occur when used under load.

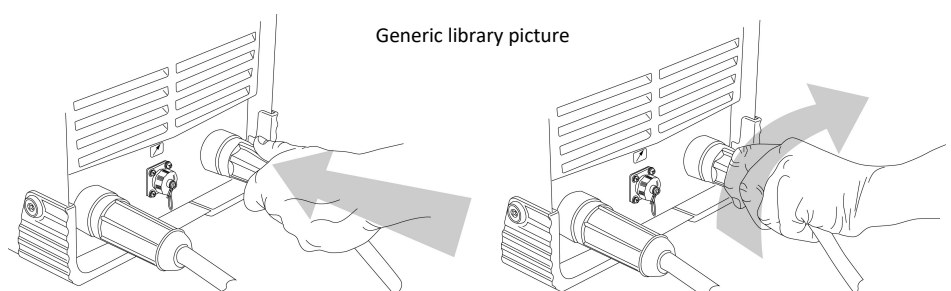

INSTALLATION

Output connections

Plasma torch

The PT100 plasma torch supplied has the 'euro style' power/gas connection (in this case the gas used is compressed air), pilot cable and switch pins connections.

All plasma cutting system and torch incorporate a safety circuit to prevent operator injury when changing consumables etc. This is a simple ring circuit that breaks the electrical torch switching as soon as the retaining cap is removed preventing machine operation.

Without such a protection circuit as previously mentioned the open circuit voltage could be as high as 350V DC at the torch head.



The torch head encompasses a full set of consumables as shown right, these consumables are made up of a cooling tube, torch electrode, swirl ring for gas distribution, cutting tip, retaining cap and if required a stand off device to ensure the same distance between tip and material being cut.

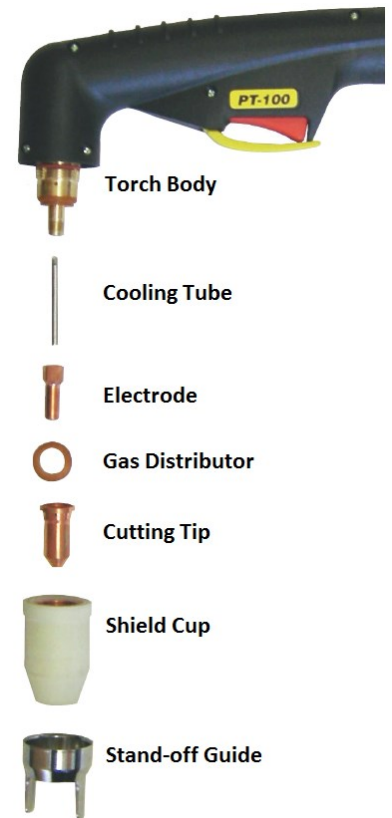

Fitting the PT100 plasma torch

On the Jasic Cut 81 plasma machine, the below torch fitting instructions will need to be observed.

- ⇒ Locate plasma torch plug into euro connector socket as shown in image 1 below
- ⇒ Push the torch (image 1) whilst at the same time rotate the locking nut on torch clockwise until fully connected and tight as in (image 2 below)



Image 1



Image 2

WHAT IS PLASMA?

- Plasma is commonly described as the fourth state of matter (i.e. solid, liquid, gas then plasma).
- If you increase gas to an extremely high temperature you get the fourth state plasma, the energy begins to break apart the gas molecules and the atoms begin to split. Normal atoms are made up of protons and neutrons in the nucleus surrounded by a cloud of electrons. In plasma, the electrons separate from the nucleus. Once the energy of heat releases the electrons from the atom, the electrons begin to move around quickly. The electrons are negatively charged and they leave behind their positively charged nuclei. These positively charged nuclei are known as ions. When the fast-moving electrons collide with other electrons and ions, they release vast amounts of energy. This energy is what gives plasma its unique status and unbelievable cutting power.

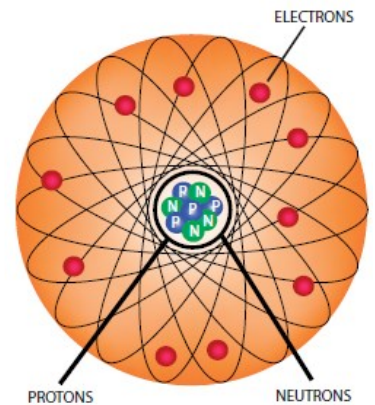

- Plasma is a gas which has been heated to an extremely high temperature and ionized so that it becomes electrically conductive. An example of naturally occurring plasma is lightning.
- The plasma arc cutting, gouging and welding processes uses plasma to transfer an electrical arc to the work piece, the electrically conductive gas will transfer the energy from the plasma power source through a plasma torch to the material being cut.
- The plasma arc cutting process basics can be seen in the illustration. The basic principle is that the arc is formed between the electrode and the work piece by forcing the plasma gas and the electrical arc through a small orifice within the copper tip. This will increase the speed and temperature of the plasma exiting the tip. The temperature of the plasma is in excess of 15000°C and the speed can approach that of sound. This plasma gas flow in conjunction with the high temperature enables a deeply penetrating plasma jet to cut through the work piece material and at the same time molten material is blown away from the cut.
- The process differs from the oxy-fuel process in that the plasma process works by using the high temperature arc to melt the metal to be cut. With the oxy-fuel process, the oxygen oxidises the metal to be cut and the heat from the exothermic reaction melts the metal. So, unlike the oxy-fuel process, the plasma process can be used to cut metals including those which form protective refractory oxides such as aluminium, stainless steel, non-ferrous alloys and cast iron.
- The output current (amps) of the power supply will determine the cutting thickness and speed capabilities of the plasma machine.
- While the primary goal of plasma arc cutting is the separation of metal, plasma arc gouging is used to remove metals to a controlled depth and width.
- Plasma machines consist of a power supply, an arc starting circuit, a plasma torch and a compressed air supply.
- Direct current (DC) straight polarity is used for plasma cutting with the electrode being - negative and the tip/work piece being + positive.

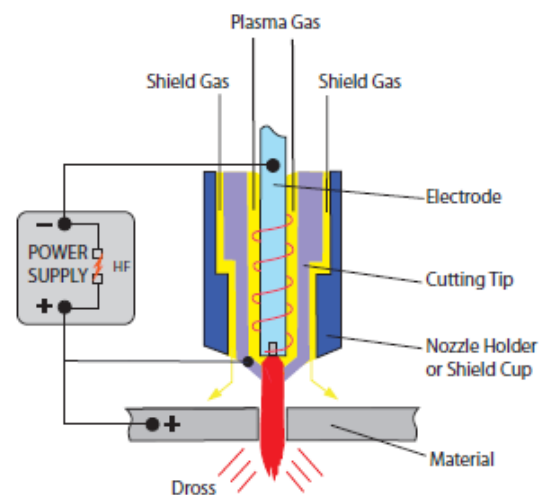

OPERATION



Before starting any welding or cutting activity ensure that you have suitable eye protection and protective clothing. Also take the necessary steps to protect any persons within the welding area.

Plasma cutting

Check that all connections have been made as required. Check the following before starting the machine.

- Check if the machine is reliably grounded according to the relevant local standards.
- Check that there are no bad contacts.
- Check if the mains power cable is connected to the correct input voltage and rated supply.
- Check if the plasma torch, connecting cables and gas hoses are in good condition and are not twisted.

Operation

1. Set cutting current according to the thickness of work piece.
2. Ensure that the cutting tip and consumables fitted matches the application and cutting amperage setting of the machine.
3. Turn on the power switch on the back panel of the machine and the power LED is on.
4. To check the air pressure by placing the purge/run switch into purge to set the correct pressure.
5. Select trigger mode required via the front control panel, 2T and 4T (see further notes on page 22)
6. There are two functions available: normal cutting and metal mesh cutting, please note that the electrode and nozzle are more easily to wear out in metal mesh cutting due to the pilot arc being more active for longer.
7. Bring the copper nozzle of the cutting torch at a distance of about 2mm between the copper nozzle of the torch and the work piece and then push the torch trigger. For other modes of cutting/gouging, please see below 'Modes of cutting'.
8. After the arc has ignited, cutting starts and you can now start moving the torch at a regular speed along the material you are cutting.

Modes of cutting

Drag cutting is the process of dragging the tip of the torch along the work piece to cut the metal.

This is often the easiest way to cut while minimizing heat input but usually only on cutting currents of 40amps and below. Drag cutting does require a 'drag' cutting tip and you need to ensure that the plasma machines output amperage is matched to the amperage with the tip. It can often be helpful to use a non-conductive straight edge to help maintain a straight cut. This technique works best when cutting metal that is less than or equal to 5mm. When you start to drag cut, you would place the tip of the torch on the work piece and begin dragging the tip across the work piece. You should always start with the torch placed at farthest point from you and then cut by pulling the torch towards you. Make sure to keep the torch upright to the material being cut throughout the cutting process. As you are drag cutting ensure you maintain a smooth and consistent travel speed to make a clean, precise cut.

Stand-off cutting is a cutting technique where the operator will hold the plasma torch so that the tip of the torch is between 3-4mm from the work piece to achieve the optimum cut. Stand-off cutting requires a cutting tip that you need to ensure that the plasma machines output amperage is matched to the amperage with the tip. A stand-off guide, roller guides and circle cutting guide kits can be very helpful in creating the cuts you want. To begin cutting you would place the torch above the work piece of about 3-4mm and begin drawing the tip across the work piece. You should always start with the torch placed at farthest point from you and then cut by pulling the torch towards you. Make sure to keep the torch upright to the material being cut throughout the cutting process. As you are cutting ensure you maintain a smooth and consistent travel speed to make a clean, precise cut.

OPERATION



Before starting any welding or cutting activity ensure that you have suitable eye protection and protective clothing. Also take the necessary steps to protect any persons within the welding area.

Modes of cutting

Piercing is the process in which a quick hole is made in the work piece. Piercing is often just a starting hole that will be used to make a 'circular' cut within the material being cut. You can use standard cutting tips for piercing although ensure the plasma machines output amperage matches the cutting tip amperage rating. The thickness of the material to be pierced will need to fall in the correct amperage range for the machine and cutting tip installed. If the material is slightly thicker than the machines piercing capacity, you can pre-drill a hole and treat your cut like an edge start cut.

There are two different techniques for piercing depending on the thickness of the work piece.

If the work piece is less than 2mm sheet metal, the torch can be held at a 90° (perpendicular) angle to the material being cut with the cutting tip or torch stand off touching or about 2mm away from the work piece (this can depend on which consumable configuration you have installed). Begin by establishing the pilot arc and as soon as the pilot arc/main cutting arc penetrates the work piece maintain your normal cutting height and the cutting process can then begin.

If the material being cut is thicker than 2mm the torch should be held at a 30-60° angle approximately 2 or 3mm above the work piece ensuring to direct the 'blown back' particles away from the torch tip, operator and any bystanders. Begin by establishing the pilot arc and when the pilot arc transfers, use a smooth, slow rolling motion to move the torch to a 90° (perpendicular) angle. At this point, the pierce should have been created (if not hold the torch still until the cutting arc sparks exits the bottom of the work piece). Now the pierce has been made, the cutting process can begin.

Bevelling allows you to angle the edge of a flat plate or pipe to allow for deeper weld penetration.

This process is normally used for materials that are 9mm or thicker. You can utilize standard cutting tips for bevelling, again, you need to ensure you utilize the correct plasma machine amperage to match the cutting tips used. Ensure that the thickness of the material to be bevelled falls in the amperage range of the plasma machine and cutting tip that you will be using. If bevelling by hand, a roller and/or angle guide can be helpful in maintaining the consistent bevel face and the desired angle which is usually determined by the weld joint design. The industry standard angle ranges are from 15-45°. The cutting tip would normally be between 3-6mm from the work piece.

Gouging creates a smooth, clean concaved groove within the material being gouged which is often weld ready. This process is primarily used for weld removal or back gouging. Gouging has specific consumables and settings depending on the gouge you need to produce which include the gouging tip and often the shield cup and possibly a gas distributor would be specific to gouging. To begin the gouging process, hold the tip of the torch approximately 12mm from the work piece angling the torch approximately 20-40° to the surface, engage the pilot arc and once established, slowly move the tip closer to the work piece until the main arc has transferred. Once the main arc is established, retract the tip until the distance from the work piece to the tip is approximately 15mm. Make sure that you keep the tip of the torch angled approximately 20-40° during this entire gouging process. To create a narrow u-groove in the work piece, the operator should maintain a constant, smooth travel speed. With this technique the gouge created will be approximately 6mm wide by 6mm deep but this may depend on the gouging tip profile. To create a wider groove, you can oscillate the plasma torch side to side in a half-moon sequence while maintaining a constant, smooth travel speed. The gouge created will be wider but not as deep.

Due to the nature of the gouging process, lead covers, gouging deflectors and torch covers are some accessories that will help to protect the equipment used in the gouging process.

Gouging can be carried out on all conductive materials.

CUT QUALITY

The plasma process cuts by melting the material and therefore a characteristic feature is the greater degree of melting towards the top of the metal resulting in poor edge squareness, top edge rounding or a bevel on the cut edge. Cut quality can often depend on setup and your application parameters with torch height, cutting speeds, compressed air pressures along with the user abilities to maintain these during the cutting process.

To help understand cut quality, it is best that the characteristics of the finished cut are looked at in close detail, the image adjacent will help explain this.

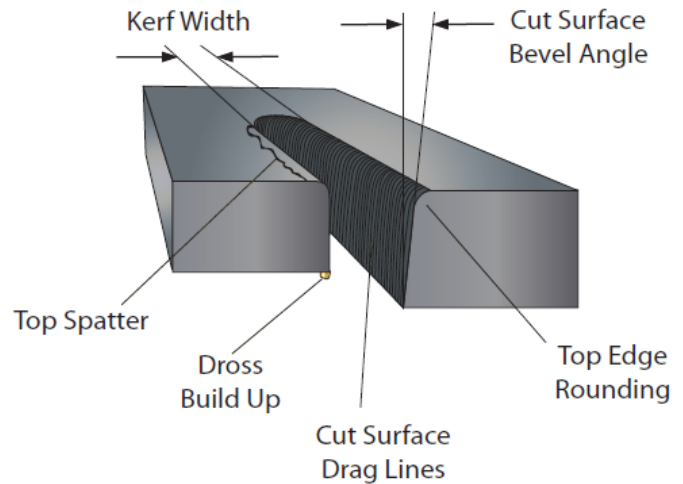

Cutting or torch angle

Generally when cutting with a plasma torch, the torch should be held perpendicular to the piece being cut.

Stand off distance

The distance between the torch tip and the work piece during the cutting process will have an effect on the bevel angles. The greater the distance, the greater the bevel angle will be. Typically, smaller hand cutting systems (40 amps and under) are designed to drag the tip on the plate. For higher amperage hand cutting systems, use of a drag shield cup, a standoff guide or a cutting guide will help keep a consistent tip to work distance for best results.

Kerf width

While plasma cutting a void is left behind which is called the kerf in the material being cut.

Bevel angle

In an ideal cut, the bevel angle or angle of the cut surface would be perfectly square. The plasma cutting process does result in a slight angle which is called a bevel angle, on both the cut and scrap side of the work piece. This is why direction of cut is important. When the plasma gas flows, it has a swirling action as it leaves the cutting tip's orifice. This swirl is generally in a clockwise direction which results in one side of the material being cut being squarer than the other. This means it is very important to consider the travel direction in relation to the piece being cut. In the image adjacent, a circle shaped object is being cut. The inside cut (A) is done in the anti-clockwise direction and the outside cut (B) is done in a clockwise direction. So remember, if you are making a circular cut and plan to keep the inside round piece as your finished work, move in a clockwise direction. If you plan to keep the piece from which the circle was cut from then move in an anti-clockwise direction.

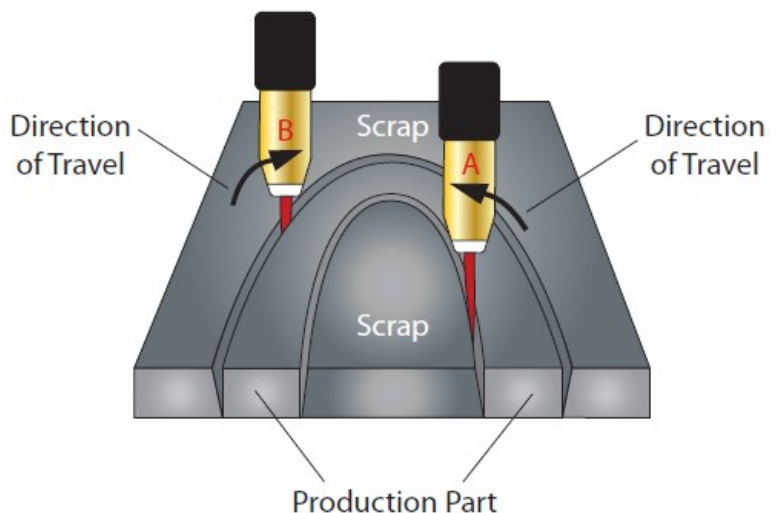

Jasic Plasma Cut 81 Circle Cutting Guide Kit - part number 51864.

CUT QUALITY

Dross

The formation of dross on the bottom of the plate can be caused when cutting parameters such as speed, amperage, arc voltage, gas pressure/flow and type of gas are not correct for the metal type and thickness being cut. Most commonly, incorrect cutting speeds are to blame for excessive dross. High cutting speeds can result in high speed dross that can be very hard to remove without grinding. Low speed dross can be easily removed with a brush or chip hammer.

Top edge rounding

This is when the top edge of the cut face has eroded away and is not square which is created from the plasma cutting process. It is generally caused when cutting with excessive current or standoff distance. This can be a common occurrence when cutting thickness materials.

TYPICAL CUTTING SPEEDS

Cutting speeds can vary according to power source output, cutting table quality, material thickness along with material type being cut as well as the operators skill set.

Speeds shown below are offered as a guide only for our Jasic cutting systems using compressed air, cutting mild steel material with the stated output currents ensuring that the cutting tip fitted matches the stated amperages.

Material Thickness	Amperage	Speed mm/m	Air Pressure
1mm	40	5000 - 6000	5 bar / 73psi
	60	6200 - 7000	5 bar / 73psi
	80	7200 - 8000	5 bar / 73psi
3mm	40	1800 - 2600	5 bar / 73psi
	60	3200 - 4200	5 bar / 73psi
	80	3800 - 4600	5 bar / 73psi
6mm	40	800 - 1100	5 bar / 73psi
	60	1200 - 2000	5 bar / 73psi
	80	1800 - 2500	5 bar / 73psi
12mm	40	200 - 300	5 bar / 73psi
	60	400 - 650	5 bar / 73psi
	80	650 - 820	5 bar / 73psi
15mm	60	400 - 500	5 bar / 73psi
	80	450 - 540	5 bar / 73psi
	100	750 - 880	5 bar / 73psi
20mm	60	280 - 340	5 bar / 73psi
	80	380 - 450	5 bar / 73psi
	100	400 - 480	5 bar / 73psi
	120	650 - 750	5 bar / 73psi
25mm	80	180 - 210	5 bar / 73psi
	100	200 - 240	5 bar / 73psi
	120	300 - 380	5 bar / 73psi
	160	400 - 480	5 bar / 73psi
30mm	160	320 - 400	5 bar / 73psi
45mm	160	230 - 350	5 bar / 73psi

GENERAL CUTTING INFORMATION



Before starting any welding or cutting activity ensure that you have suitable eye protection and protective clothing. Also take the necessary steps to protect any persons within the welding area.

Notes for cutting operation

1. Do not touch the hot work piece with bare hands to avoid burning.
2. It is recommended not to ignite the arc in the air if not necessary, for it will shorten the lifespan of the electrode and nozzle of the torch.
3. It is recommended to initiate the cutting from the edge of the workpiece unless penetration is needed.
4. Ensure spatter comes from the bottom of work piece while cutting. If spatter comes upwards from the top of work piece, it indicates that the work piece has not been fully cut through. This could be due to not enough power or the cutting torch is moved too fast.
5. For cutting a round work piece or to meet precise cutting requirement, a stencil board or other tools are needed.
6. It is recommended to pull the cutting torch while cutting.
7. Keep the nozzle of the cutting torch upright over the work piece and check if the arc is moving with the cutting line. Do not bend the cable too much, step on or press upon the cable to avoid restricting the air flow. The cutting torch may be burned if the air flow is too low. Keep the cutting cable away from sharp edges.
8. When the work piece is nearly cut off, slow down the cutting speed and release the torch trigger to stop cutting.
9. Check the torch consumables frequently to prolong the life.
10. Always ensure the correct consumables are fitted in the torch. Incorrect items may cause damage to the torch or machine.
11. It is recommended that a torch of maximum length of 6 metres is used. If the torch cable is too long, the performance of this cutting machine such as arc ignition will possibly be affected due to the fact that the inner resistance of the cable will reduce the output voltage.
12. When using the plasma torch latch switch in 4T mode, its important to remember that once you have transferred from pilot arc mode to main cutting that you remove your finger from the trigger, this will ensure that the output pilot current rises to the preset value set and shown on the digital display! If you keep your finger pressed on the trigger the machines output current will stay at initial current and will not step up to set current until you release the torch trigger!

Please Note:

- * Your air supply must be free of moisture, water, oil or any other contaminants. Excessive water or oil may cause double arcing, excessive electrode/tip wear or even torch head failure. Contaminants will also cause poor cut quality.
- * When starting the arc, ensure you keep the pilot arc time to a minimum to avoid excessive wear on the cutting tip.
- * Do not overtighten the electrode when fitting a new set of consumables. Over tightening may cause damage to the head thread, the tip not to seat correctly
- * Only use the supplied or recommended 'O' ring lubricant or grease for your plasma torch head, using the wrong lubricant which cannot withstand high temperatures could cause damage to the plasma torch head.

HAND TORCH CONSUMABLE BREAKDOWN

The Jasic Cut 81 is supplied with the 6m PT100 plasma torch



PT100 6m - Pt No 09721/LG

PT100 12m - Pt No 09726/LG

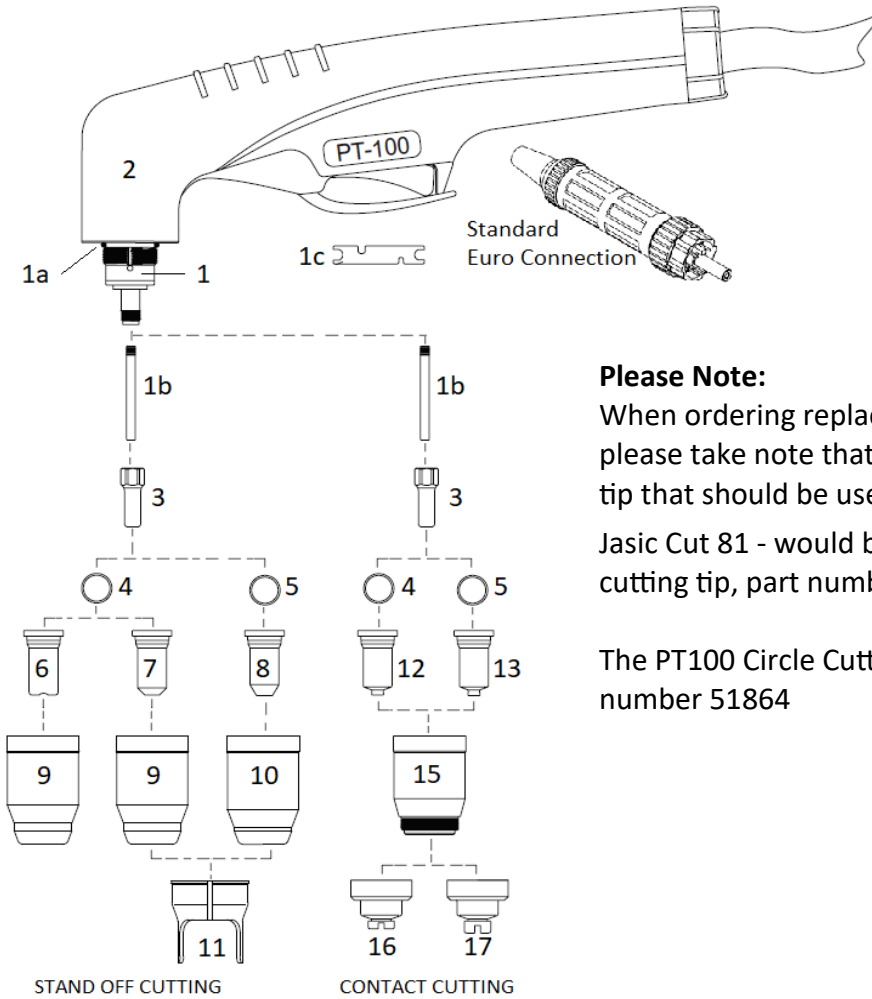

Please Note:

When ordering replacement cutting tips please take note that the maximum sized tip that should be used is as follows:

Jasic Cut 81 - would be the 80-90amp 1.4 cutting tip, part number 51248.14

The PT100 Circle Cutting Guide Kit is part number 51864

Item No	Part Number	Description	Pack Qty
1	09700	PT100 Torch Head	1
1a	51190.41	Torch Head 'O' Ring	5
1b	09700.48	Cooling Tube	1
1c	60368	Wrench for Electrode	1
2	09705	Handle c/w Switch	1
3	52556	Electrode - Back Striking	5
4	60025	Gas Distributor (Swirl Ring) 30-70A	1
5	60026	Gas Distributor (Swirl Ring) 80A	1
6	51245.09	Contact Cutting Tip (0.9) 30-40A Back Striking	10
7	51246.10	Tip Cutting 1.0mm 40-50A Back Striking	10
7	51246.11	Tip Cutting 1.1mm 50-60A Back Striking	10
7	51246.12	Tip Cutting 1.2mm 60-70A Back Striking	10
8	51248.14	Tip Cutting 1.4mm 80-90A Back Striking	10
9	60500	Retaining Cap 30-70A	1
10	60501	Retaining Cap 80A	1
11	60444	Double Pointed Spacer (use with items 7 & 8 only)	1
12	51276.10	Contact Tip 1.0mm 40-50A	10
12	51276.11	Contact Tip 1.1mm 50-60A	10
12	51276.12	Contact Tip 1.2mm 60-70A	10
13	51278.14	Contact Tip 1.4mm 80A	10
15	60502	Shield Cup Body	1
16	60504	Shield Cap 40-70A	1
17	60505	Shield Cap 80A	1

Please Note: Configuration above only to be used on the Jasic Cut 81 Plasma Machine

HAND TORCH CONSUMABLE BREAKDOWN

The Jasic Cut 81 is supplied with the 6m PT100 plasma torch



Stand off and exposed contact tip cutting setup

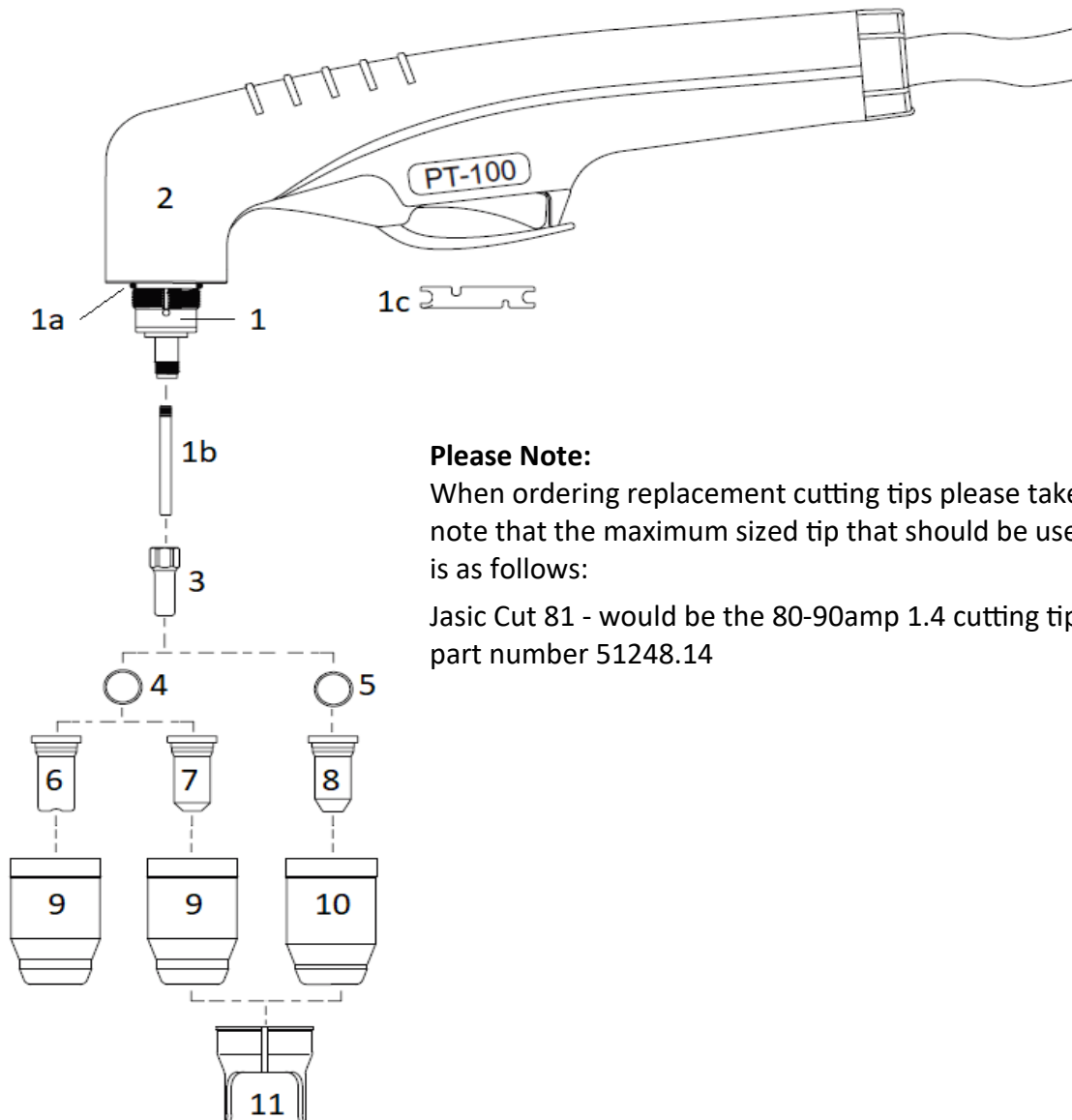

Please Note:

When ordering replacement cutting tips please take note that the maximum sized tip that should be used is as follows:

Jasic Cut 81 - would be the 80-90amp 1.4 cutting tip, part number 51248.14

Item No	Part Number	Description	Pack Qty
1	09700	PT100 Torch Head	1
1a	51190.41	Torch Head 'O' Ring	5
1b	09700.48	Cooling Tube	1
1c	60368	Wrench for Electrode	1
2	09705	Handle c/w Switch	1
3	52556	Electrode - Back Striking	5
4	60025	Gas Distributor (Swirl Ring) 30-70A	1
5	60026	Gas Distributor (Swirl Ring) 80A	1
6	51245.09	Contact Cutting Tip (0.9) 30-40A Back Striking	10
7	51246.10	Tip Cutting 1.0mm 40-50A Back Striking	10
7	51246.11	Tip Cutting 1.1mm 50-60A Back Striking	10
7	51246.12	Tip Cutting 1.2mm 60-70A Back Striking	10
8	51248.14	Tip Cutting 1.4mm 80-90A Back Striking	10
9	60500	Retaining Cap 30-70A	1
10	60501	Retaining Cap 80A	1
11	60444	Double Pointed Spacer (use with items 7 & 8 Only)	1

Please Note: Configuration above only to be used on the Jasic Cut 81 Plasma Machine

HAND TORCH CONSUMABLE BREAKDOWN

The Jasic Cut 81 is supplied with the 6m PT100 plasma torch



Drag cutting (enclosed tip) setup

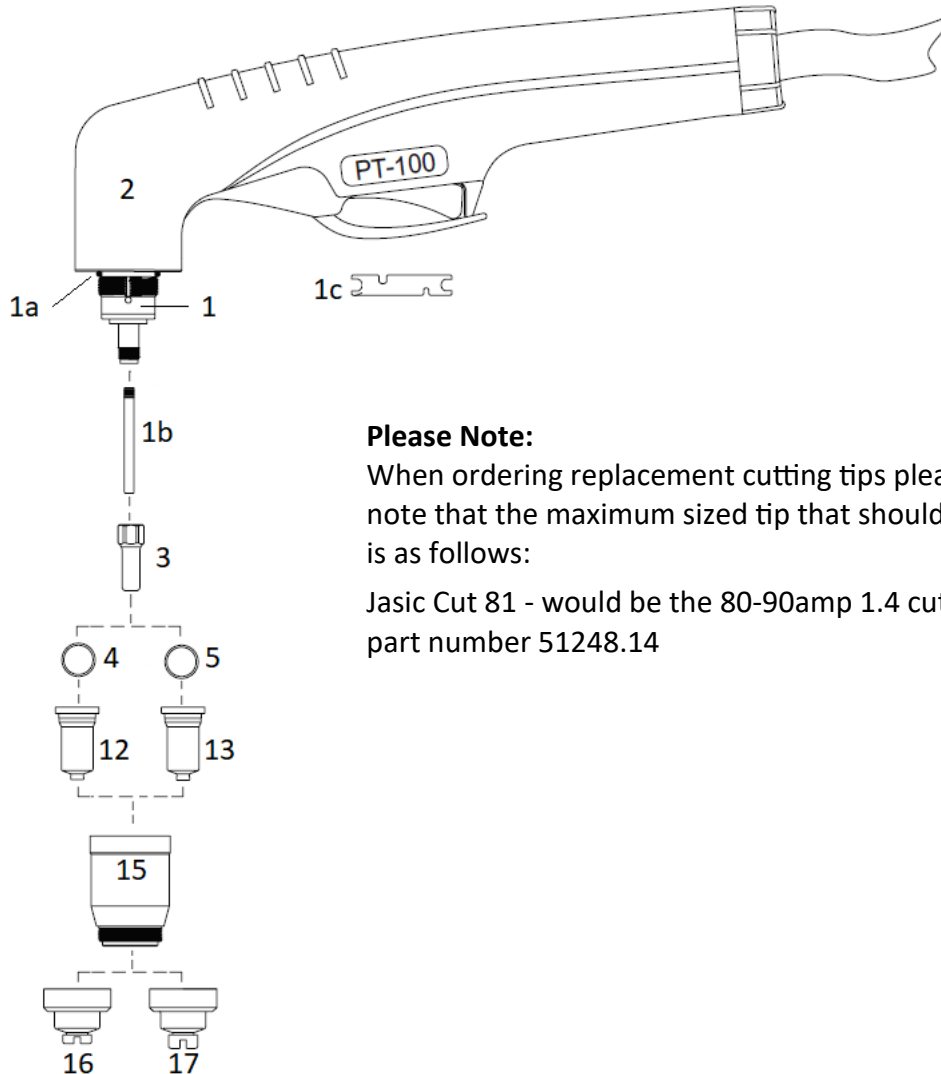

Please Note:

When ordering replacement cutting tips please take note that the maximum sized tip that should be used is as follows:

Jasic Cut 81 - would be the 80-90amp 1.4 cutting tip, part number 51248.14

Item No	Part Number	Description	Pack Qty
1	09700	PT100 Torch Head	1
1a	51190.41	Torch Head 'O' Ring	5
1b	09700.48	Cooling Tube	1
1c	60368	Wrench for Electrode	1
2	09705	Handle c/w Switch	1
3	52556	Electrode - Back Striking	5
4	60025	Gas Distributor (Swirl Ring) 30-70A	1
5	60026	Gas Distributor (Swirl Ring) 80A	1
12	51276.10	Contact Tip 1.0mm 40-50A	10
12	51276.11	Contact Tip 1.1mm 50-60A	10
12	51276.12	Contact Tip 1.2mm 60-70A	10
13	51278.14	Contact Tip 1.4mm 80A	10
15	60502	Shield Cup Body	1
16	60504	Shield Cap 40-70A	1
17	60505	Shield Cap 80A	1

Please Note: Configuration above only to be used on the Jasic Cut 81 Plasma Machine

MACHINE TORCH CONSUMABLE BREAKDOWN



TM125 6m - Euro (Pt No 70061)

TM125 12m - Euro (Pt No 03736CX)

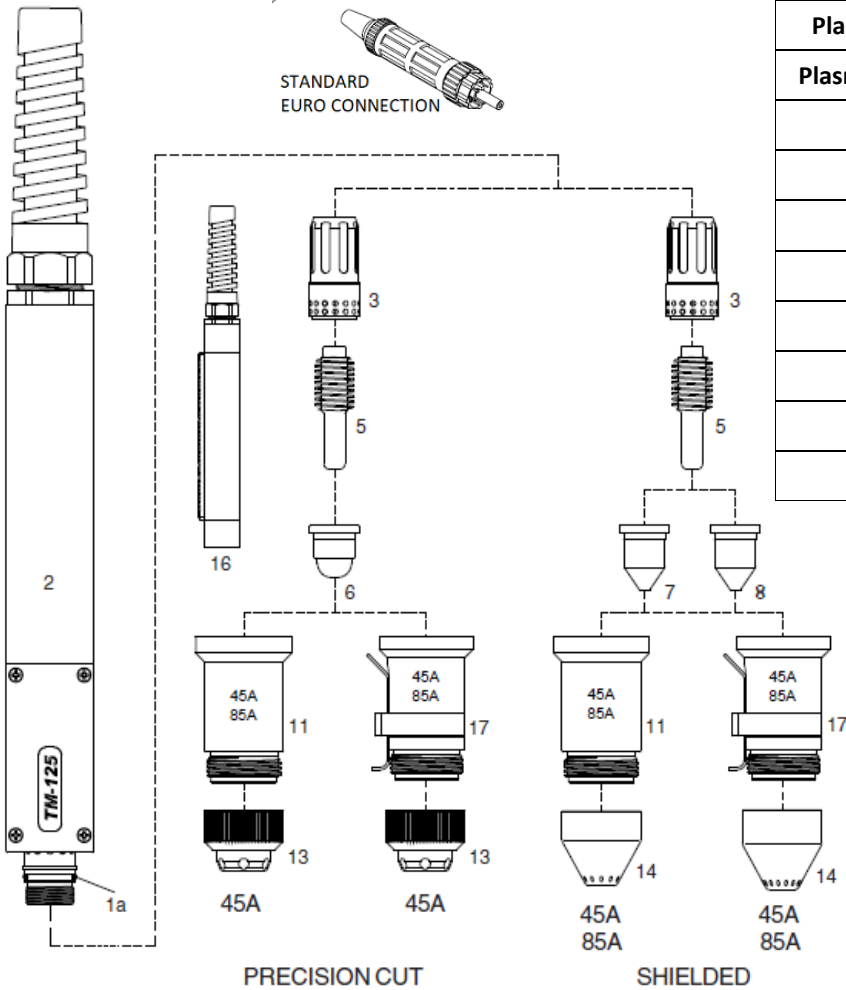

Plasma Torch TM125 6m :	Pt No: 70061
Plasma Torch TM125 12m :	Pt No: 03736CX
Current :	40 - 125 Amps
Duty Cycle :	125 Amps at 60%
Gas :	Air/N2
Gas Pressure - Cutting :	72-87 PSI (5.0-6.0 bar)
Gas Flow @ 125A :	630 SCFH (295 lpm)
Post Flow Time :	45 Seconds
Pilot Arc Current :	15 - 18 Amps
Pilot Arc Ignition :	NON HF

Please Note:

The Jasic Cut 81 has an output current rating of 80amps and the machine plasma torch recommended for this machine is the TM125 which has a current rating of up to 125amps.

When selecting your consumables, please take note that the maximum sized tip to be used would be the 85amp cutting tip.

Item No	Part Number	Description	Pack Qty
1	03710	Torch Head	1
1a	03700.60	Torch Head 'O' Ring	10
2	07218	Positioning Tube	1
3	220857	Swirl Ring (45-85A) Max Life	1
5	52677	Electrode (45-105A)	5
6	220930	Cutting Tip (45A Precision Cut)	10
7	220941	Cutting Tip (45A)	10
8	220819	Cutting Tip (65A)	10
9	220816	Cutting Tip (85A)	10
11	60309TA	Shield Cup Body (45-85A)	1
13	51929	Shield Cap (45A) Precision Cut	1
14	220817	Machine Shield (45-85A)	1
16	07219	Positioning Tube With Rack	1
17	60309THA	Shield Cup Body (45-85A) C/W Ohmic Clip	1

Please Note: Configuration above only to be used on the Jasic Cut 81 Plasma Machine

MAINTENANCE



The following operation requires sufficient professional knowledge on electric aspects and comprehensive safety knowledge. Make sure the input cable of the machine is disconnected from the electricity supply and wait for 5 minutes before removing the machine covers.

In order to guarantee that your cutting and welding machine works efficiently and in safety, it must be maintained regularly.

Operators should understand the maintenance methods and means of cutting and welding machine operation.

This guide should enable customers to carry out simple examination and safeguarding by oneself, try to reduce the fault rate and repair times of the welding and cutting equipment, so as to lengthen the service life of your plasma machine.

Period	Maintenance item
Daily examination	Check the condition of the machine, mains cables, welding cables and connections. Check for any warnings LEDs and machine operation. Check the torch consumable condition and replace if worn. Check the compressor air supply and adjust as required.
Monthly examination	Disconnect from the mains supply and wait for at least 5 minutes before removing the cover. Check internal connections and tighten if required. Clean the inside of the machine with a soft brush and vacuum cleaner. Take care not to remove any cables or cause damage to components. Ensure that ventilation grills are clear. Check inline air filters. Carefully replace the covers and test the unit. This work should be carried out by a suitably qualified competent person.
Yearly examination	Carry out an annual service to include safety check in accordance with the manufacturers standard (EN 60974-1). This work should be carried out by a suitably qualified competent person.

Please note : Do not use compressed air to blow the dirt/dust out of the power supply.

MAINTENANCE



The following operation requires sufficient professional knowledge on electric aspects and comprehensive safety knowledge. Make sure the input cable of the machine is disconnected from the electricity supply and wait for 5 minutes before removing the machine covers.

Please note: The following should only be carried out by an electrical technician.

Air pressure setting

The internal air pressure regulator is preset prior to leaving the factory and the users should not need to set it.

If for any reason adjustment is required then it should only be carried out by a competent person only and by following the instructions below:

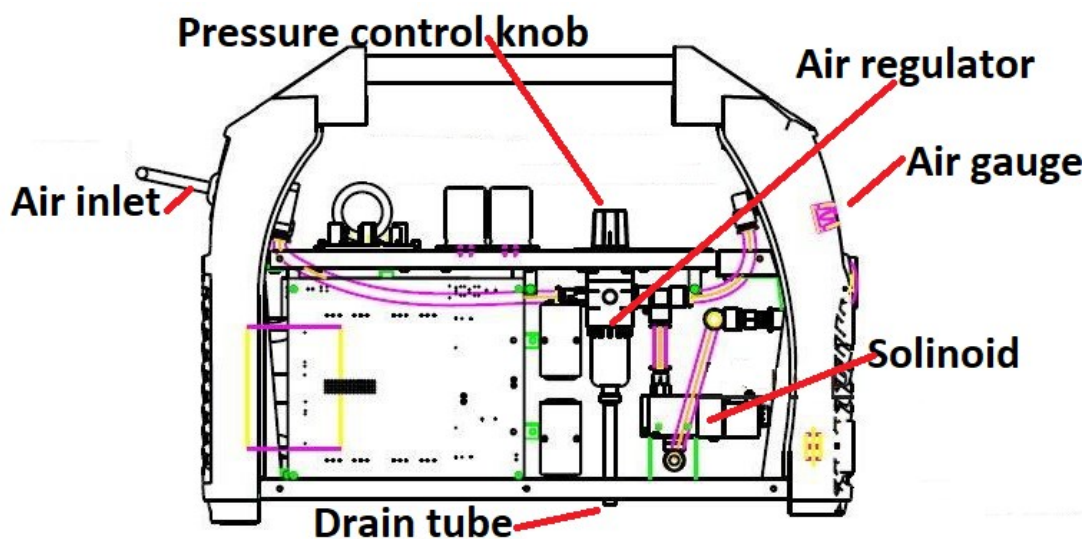

1. Switch off and unplug the machine and leave for 5 minutes to ensure any stored energy has dissipated
2. Carefully remove the machine cover panel and handle
3. Connect the air supply to the machine
4. Ensure the plasma torch is fully fitted
5. Reconnect the machine to the mains supply and switch the machine back on still taking care not to touch any electrical parts within the machine
6. Switch on the air purge switch located on the front panel to start the airflow through the machine and plasma torch
7. Lift up the pressure control knob (shown on the illustration above) of the pressure regulator to unlock it
8. Adjust the pressure by rotating the knob in the "+" clockwise direction to increase the air pressure or turn the knob in the "-" anticlockwise direction to reduce the pressure
9. When the correct pressure is set on the air pressure gauge located on the control panel, you can then push down the adjusting knob to re-lock it
10. Turn off the machine and unplug from the input mains supply
11. Replace the panel and handle and ensure all the screws are fully located and in place

Please Note:

Any water which has been collected by the air regulator will be drained by the auto drain of the regulator. Ensure that your compressed air supply is always clean and dry.

TROUBLESHOOTING



The following operation requires sufficient professional knowledge on electric aspects and comprehensive safety knowledge. Make sure the input cable of the machine is disconnected from the electricity supply and wait for 5 minutes before removing the machine covers.

Before any welding and cutting machines are dispatched from the factory, they have already been checked thoroughly. The machine should not be tampered with or altered. Maintenance must be carried out carefully. If any wire becomes loose or is misplaced, it may be potentially dangerous to the user!

There are dangerous voltages present within this plasma power supply unit. Only professionally trained maintenance personnel should repair the machine!

Ensure the power is disconnected before working on the machine. Always wait 5 minutes after power switch off before removing the panels.

Description of fault	Possible cause
Mains power switch is on, although the power indicator doesn't light up.	Check input power that it is turned on. Check the input power fuse. Check the input cable plug and connections. Check the ON/OFF switch for function and continuity.
Primary power switch is on, but the cooling fan does not work.	Check fan is not being blocked by debris. Check fan for functionality. Check fan supply.
No air flow at torch when either torch trigger is pressed or air purge switch is activated.	Check the compressor. Check all the input air connections and fittings. Internal connection is disconnected or loose. Check the purge switch for functionality.
Overheat LED lit.	Machine operated outside duty cycle, allow the machine to cool and the unit will reset automatically. Fan not working - check for obstruction blocking the fan.
Pilot arc does not initiate when the torch switch is activated.	Gas pressure too low to the machine.

Plasma cutting problems

The proper installation, application and operation of plasma arc cutting equipment can save many man hours and reduce costs which will give you the promised cut quality and longer consumable parts life.

Cut quality issues or poor consumable life are generally the most experienced problems seen with plasma cutting systems and more often than not are caused by the same thing, for example, low or too high air pressure, low air flow, water or oil in the supply airline will all give you poor cut quality and premature consumable wear. It's often difficult to diagnose cutting issues without understanding the machines use and setup and there are various questions that need to be asked to be able to give the best advice.

Below is listed a few pointers to help you on your way to obtaining consistently good cut quality:

- Ensure your mains power supply is suited to the plasma cutting machines specifications.
- Ensure the supplied gases or air supply is in keeping with the requirements of the plasma machine.
- Ensure your plasma machines amperage setting matches the cutting tips amperage.
- Clean and service the plasma machine and torch regularly, it is important that the operator watch the torch for signs of contamination or worn consumables being used.

Plasma Cutting Problems

Problem	Possible cause	Suggested action
Excessive use of consumables (short life time of consumables)	Low air pressure or low air flow (or too high)	Check for low air pressure to the plasma machine (low flow can be caused by a long air hose with a small internal diameter or leaks). Ensure your compressor is set to deliver the correct CFM as detailed in the plasma owner's manual and can keep this level maintained during your cutting operation (consider other equipment being used on the same airline).
	Contaminated gas or excessive moisture in the air supply	Use suitable airline filters or air dryers and service the devices as required as per the user manual. If using a compressor, ensure the receiver is drained regularly.
	Drag cutting at high amperages	Refer to the torch spare parts of this manual for the correct use of cutting tips and their amperage ratings.
	Dragging the cutting tip against a metallic straight edge	Ensure you use a non-metallic straight edge to guide the torch along.
	Excessive piloting	Keeping the pilot arc maintained will erode the consumables much faster than when cutting, keep piloting to a minimum as this will wear consumables quicker.
Poor cut quality	Improper travel speed	Refer to the cutting guide chart on page 21 of this user manual for the correct settings for the material being cut.
	Cutting amperage not correct	Refer to the cutting guide chart on page 21 of this user manual for the correct settings for the material being cut.
	Stand-off height not correct	Refer to the cutting guide chart on page 21 of this user manual for the correct settings for the material being cut. Ensure when using the torch trigger latch switch in 4T mode that once you have started the cutting process you remove your finger from the trigger, if you don't the output current will not rise the preset current shown on the digital display
	Using incorrect torch consumables	Refer to the plasma spare part breakdowns from page 23 of this user manual for the correct consumable configuration for the application.
	Worn consumables	Check and replace as necessary.
	Plasma not delivering enough output current	Have a technician check the output current of the plasma to ensure it is meeting demand.
	Incorrect air pressure or air flow to the machine	Check machines air demand specifications, refer to page 12 within this user manual to ensure air supply meets the requirements.

WEEE disposal

The equipment is manufactured with materials which do not contain any toxic or poisonous materials dangerous to the operator.

When the equipment is scrapped, it should be dismantled separating components according to the type of materials.

Do not dispose of the equipment with normal waste. The European Directive 2002/96/EC and United Kingdom's Directive The Waste Electrical and Electronic Equipment (WEEE) regulations 2013 states that electrical equipment that has reached its end of life must be collected separately and returned to an environmentally compatible recycling facility.

Jasic has a relevant recycling system which is compliant and registered in the UK with the environment agency. Our registration reference is WEEMM3813AA.

In order to comply with WEEE regulations outside the UK you should contact your supplier.

RoHS Compliance Declaration

We herewith confirm, that the above mentioned product does not contain any of the restricted substances as listed in EU Directive 2011/65/EU and the UK directive ROHS Regulations 2012 in concentrations above the limits as specified therein.

UKCA Declaration of Conformity

The manufacturer, or its legal representative Wilkinson Star Limited, declares that the equipment described below is designed and produced according to following UK legislation:

- Electrical equipment safety 2016
- Electromagnetic compatibility (EMC) regulations 2016
- The restrictions of the use of certain hazardous substances in electrical and electronic equipment regulations 2012

And inspected according to following designated standards:

- EN 60 974-1:2018+A1:2019
- EN 60 974-10:2014+A1:2015

Any alteration or change to these machines by any unauthorized person makes this declaration invalid.

Model:

JP-81

Authorised Representative:

Wilkinson Star Limited
Shield Drive
Wardley Industrial Estate
Worsley
Manchester
M28 2WD

Disclaimer:

Please note that this confirmation is given to the best of our present knowledge and belief. Nothing herein represents and/or may be interpreted as warranty within the meaning of the applicable warranty law.

EC Declaration of Conformity

The manufacturer, or its legal representative **Wilkinson Star Limited**, declares that the equipment described below is designed and produced according to following EU Directives:

- Low Voltage Directive (LVD), No.: 2014/35/EU
- Electromagnetic compatibility (EMC) Directive, No.: 2014/30/EU

And inspected according to following
EU - Norms:

- EN 60 974-1:2012
- EN 60 974-10:2014+A1

Any alteration or change to these machines by any unauthorized person makes this Declaration invalid.

Wilkinson Star model
JP-61
JP-81

Jasic Model
CUT 60 L209
CUT 80 L210

Authorised Representative

Wilkinson Star Limited
Shield Drive, Wardley Industrial Estate,
Worsley, Manchester M28 2WD
Tel 0161 793 8127

Manufacturer

Shenzhen Jasic Technology Co LTD
No3 Qinglan, 1st Road
Pingshan District
Shenzhen, China

Signature



Dr John A Wilkinson OBE

Position Chairman

Signature

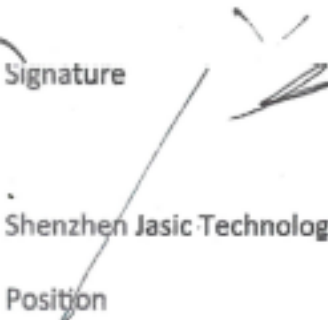

Shenzhen Jasic Technology Co LTD

Position

Date



Date



STATEMENT OF WARRANTY

All new JASIC welders, plasma cutters and multi-process units sold through our partner Wilkinson Star Limited within the United Kingdom and Ireland shall be warranted to the original owner, non transferable, against failure due to defective materials or production. The warranty period is 5 years following the date of purchase. We recommend you register your product within 28 days of purchase. The original invoice is documentation for the standard warranty period. The warranty period is based on a single shift pattern.

Defective units shall be repaired or replaced by the company at our workshop. The company may opt to refund the purchase price (less any costs and depreciation due to use and wear). The company reserves the right to alter the warranty conditions at any time with effect for the future.

A prerequisite for the full warranty is that products are operated in accordance with the operating instructions supplied, observing the relevant installation and any legal requirement recommendations and guidelines and carrying out the maintenance instructions shown in the operator manual. This should be carried out by a suitably qualified competent person.

In the unlikely event of a problem, this should be reported to the Jasic technical support team to review the claim.

The customer has no claim to loan or replacement products whilst repairs are being performed.

The following falls outside the scope of the warranty:

- Defects due to natural wear and tear
- Failure to observe the operating and maintenance instructions
- Connection to an incorrect or faulty mains supply
- Overloading during use
- Any modifications that are made to the product without prior written consent
- Software errors due incorrect operation
- Any repairs that are carried out using non-approved spare parts
- Any transport or storage damage
- Direct or indirect damage, as well as any loss of earnings are not covered under the warranty
- External damage such as fire or damage due to natural causes e.g. flooding

NOTE: Under the terms of the warranty, welding torches, their consumable parts, wire feed unit drive rolls and guide tubes, work return cables and clamps, electrode holders, connection and extension cables, mains and control leads, plugs, wheels, coolant etc. are covered with a 3 month warranty.

Jasic shall in no event be responsible for any third party expenses or expenses/costs or any indirect or consequential expenses/costs.

Jasic will submit an invoice for any repair work performed outside the scope of the warranty. A quotation for any non warranty work will be raised prior to any repairs being carried out.

The decision about repair or replacement of the defective part(s) is made by Jasic. The replaced part(s) remain(s) Jasic property.

Warranty extends only to the machine, its accessories and parts contained inside. No other warranty is expressed or implied. No warranty is expressed or implied in regards to the fitness of the product for any particular application or use.

For further information on Jasic product warranty terms and product warranty registration please visit:

www.jasic-warranty.co.uk/terms

www.jasic-warranty.co.uk

NOTES

NOTES

Wilkinson Star Limited

Shield Drive

Wardley Industrial Estate

Worsley

Manchester

UK

M28 2WD

+44 (0)161 793 8127



www.jasic.co.uk

December 2021 - Issue 4