

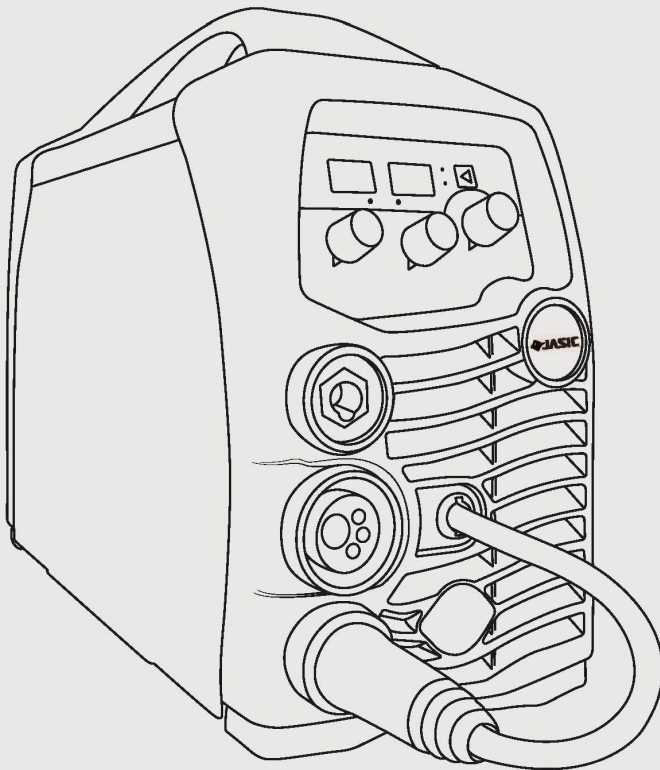

# MIG Series

MIG 200 Synergic (JM-200CS)



# Operator Manual



Intertek

CE

UK  
CA



# Your new product

Thank you for selecting this Jasic product.

This product manual has been designed to ensure that you get the most from your new product. Please ensure that you are fully conversant with the information provided paying particular attention to the safety precautions. The information will help protect yourself and others against the potential hazards that you may come across.

Please ensure that you carry out daily and periodic maintenance checks to ensure years of reliable and trouble free operation.

Please call your Jasic distributor in the unlikely event of a problem occurring.  
Please record below the details from your product as these will be required for warranty purposes and to ensure you get the correct information should you require assistance or spare parts.

Date purchased \_\_\_\_\_

From where \_\_\_\_\_

Serial number \_\_\_\_\_

(The serial number is normally located on the top or underside of the machine and will begin with AA)

For further information on your Jasic product warranty registration please visit:

[www.jasic-warranty.co.uk](http://www.jasic-warranty.co.uk)

## **Disclaimer**

Whilst every effort has been made to ensure that the information contained within this manual is complete and accurate, no liability can be accepted for any errors or omissions.

Please note:

Products are subject to continual development and may be subject to change without notice.

Regularly check our product pages at [www.Jasic.co.uk](http://www.Jasic.co.uk) for revision updated operating manuals.

No part of this manual may be copied or reproduced by any means without the written permission of Wilkinson Star Limited.

# CONTENTS

Index	Page
Your New Product	2
Index	3
Safety Instruction	4
General electrical safety	4
General operating safety	4
PPE	5
Welding processes lens shade selector guide	5
Fume and welding gases	6
Fire risks	6
The working environment	7
Protection from moving parts	7
Magnetic fields	7
Compressed gas cylinders and regulators	7
RF declaration	8
LF declaration	8
Materials and their disposal	8
Product Overview	9
Technical Specifications	10
Description of Controls	11
Multifunctional Display Window	15
Installation	16
Operation MMA	18
Operation MIG/MAG	19
Operation TIG	20
Guide to MMA Welding	21
MMA Welding Problems	25
Guide to MIG/MAG Welding	26
MIG Set-Up Guide	30
MIG Welding Problems	31
MIG Welding Torch	33
Guide to TIG Welding	34
TIG Welding Torch	38
TIG Welding Problems	39
Maintenance	41
Service Schedule Record	41
Troubleshooting	42
WEEE Disposal	43
RoHS Compliance Declaration	43
UKCA Declaration of Conformity	43
EC Declaration of Conformity	44
Statement of Warranty	45
Schematic	46
Options and Accessories	47
Notes	48
Jasic Contact Details	50

# SAFETY INSTRUCTION

These general safety norms cover both arc welding machines and plasma cutting machines unless otherwise noted.

It is important that users of this equipment protect yourselves and others from harm or even death. The equipment must only be used for the purpose it was designed for. Using it in any other way could result in damage or injury and in breach of the safety rules.

Only suitably trained and competent persons should use the equipment.

Pacemaker wearers should consult your doctor prior to using this equipment.

PPE and workplace safety equipment must be compatible for the application of work involved.

## **Always carry out a risk assessment before undertaking any welding or cutting activity**

### **General electrical safety**



The equipment should be installed by a qualified person and in accordance with current standards in accordance with current standards in operation. It is the users responsibility to ensure that the equipment is connected to a suitable power supply. Consult with your utility supplier if required. Do not use the equipment with the covers removed.

Do not touch live electrical parts or parts which are electrically charged.

Turn off all equipment when not in use.

In the case of abnormal behaviour of the equipment, the equipment should be checked by a suitably qualified service engineer.

If earth bonding of the work piece is required, bond it directly with a separate cable with a current carrying capacity capable of carrying the maximum capacity of the machine current.

Cables (both primary supply and welding) should be regularly checked for damage and overheating.

Never use worn, damaged, under sized or poorly jointed cables.

Insulate yourself from work and earth using dry insulating mats or covers big enough to prevent any physical contact.

Never touch the electrode if you are in contact with the work piece return.

Do not wrap cables over your body.

Ensure that you take additional safety precautions when you are welding in electrically hazardous conditions such as damp environments, wearing wet clothing and metal structures.

Try to avoid welding in cramped or restricted positions.

Ensure that the equipment is well maintained. Repair or replace damaged or defective parts immediately.

Carry out any regular maintenance in accordance with the manufacturers instructions.

The EMC classification of this product is class A in accordance with electromagnetic compatibility standards CISPR 11 and IEC 60974-10 and therefore the product is designed to be used in industrial environment only.

**WARNING:** This class A equipment is not intended for use in residential locations where the electrical power is provided by a public low-voltage supply system. In those locations it may be difficult to ensure the electromagnetic compatibility due to conducted and radiated disturbances.

### **General operating safety**

Never carry the equipment or suspend it by the carrying strap or handles during welding.

Never pull or lift the machine by the welding torch or other cables. Always use the correct lift points or handles. Always use the transport under gear as recommended by the manufacturer.

Never lift a machine with the gas cylinder mounted on it.

If the operating environment is classified as dangerous, only use S-marked welding equipment with a safe idle voltage level. Such environments may be for example: humid, hot or restricted accessibility spaces.

# SAFETY INSTRUCTION

## Use of Personal Protective Equipment (PPE)

Welding arc rays from all welding processes produce intense, visible and invisible (ultraviolet and infrared) rays that can burn eyes and skin.

- Wear an approved welding helmet fitted with an appropriate shade of filter lens to protect your face and eyes when welding or watching.
- Wear approved safety glasses with side shields under your helmet.
- Never use broken or faulty welding helmets.
- Always ensure there are adequate protective screens or barriers to protect others from flash, glare and sparks from the welding area.
- Ensure that there are adequate warnings that welding or cutting is taking place.
- Wear suitable protective flame resistant clothing, gloves and footwear.
- Check and be sure the area is safe and clear of inflammable material before carrying out any welding.

Some welding and cutting operations may produce noise. Wear safety ear protection to protect your hearing if the ambient noise level exceeds the local allowable limit (e.g: 85 dB).



## Welding and Cutting Lens Shade Selector Guide

CURRENT	MMA ELECTRODES	MIG LIGHT ALLOYS	MIG HEAVY METALS	MAG	TIG ON ALL METALS	PLASMA CUTTING	PLASMA WELDING	GOUGING ARC/AIR
10	8							
15								
20	9	10	10	10	10			
30								
40	10					11	11	10
60								
80	11	11		11	11			
100								
125	12	12	11	12	12		12	
150								
175	13	13		13			13	11
200								
225	14	14	13	14	13	12	14	12
250								
275	15	15	14	15	14		14	13
300								
350	16	16	15	16	15		15	14
400								
450	17	17	16	17	16		16	15
500								

# SAFETY INSTRUCTION

## Safety against fumes and welding gases



The HSE have identified welders as being an 'at risk' group for occupational diseases arising from exposure to dusts, gases, vapours and welding fumes. The main identified health effects are pneumonia, asthma, chronic obstructive pulmonary disease (COPD), lung and kidney cancer, metal fume fever (MFF) and lung function changes.

During welding and hot cutting 'hot work' operations, fumes are produced which are collectively known as welding fume. Depending upon the type of welding process being performed, the resultant fume generated is a complex and highly variable mixture of gases and particulates.

Regardless of the length of welding being carried out, all welding fume, including mild steel welding requires suitable engineering controls to be in place which is usually Local Exhaust Ventilation (LEV) extraction to reduce the exposure to welding fume indoors and where LEV does not adequately control exposure it should also be enhanced by using suitable respiratory protective equipment (RPE) to assist with protecting against residual fume.

When welding outdoors appropriate RPE should be used.

Prior to undertaking any welding tasks an appropriate risk assessment should be carried out to ensure expected control measures are in place.

Locate the equipment in a well-ventilated position and keep your head out of the welding fume.

Do not breathe the welding fume.

Ensure the welding zone is well-ventilated and provision should be made for suitable local fume extraction system to be in place.

If ventilation is poor, wear an approved airfed welding helmet or respirator.

Read and understand the Material Safety Data Sheets (MSDS's) and the manufacturer's instructions for metals, consumable, coatings, cleaners and de-greasers.

Do not weld in locations near any de-greasing, cleaning or spraying operations.

Be aware that heat and rays of the arc can react with vapours to form highly toxic and irritating gases.

**For further information please refer to the HSE website [www.hse.gov.uk](http://www.hse.gov.uk) for related documentation.**



An example of personal fume protection

## Precautions against fire and explosion



Avoid causing fires due to sparks and hot waste or molten metal.

Ensure that appropriate fire safety devices are available near the welding and cutting area.

Remove all flammable and combustible materials from the welding, cutting and surrounding areas.

Do not weld or cut fuel and lubricant containers, even if empty. These must be carefully cleaned before they can be welded or cut.

Always allow the welded or cut material to cool before touching it or placing it in contact with combustible or flammable material.

Do not work in atmospheres with high concentrations of combustible fumes, flammable gases and dust. Always check the work area half an hour after cutting to make sure that no fires have begun.

Take care to avoid accidental contact of electrode to metal objects. This could cause arcs, explosion, overheating or fire.



## **Understand your fire extinguishers**

# SAFETY INSTRUCTION

## The working environment

Ensure the machine is mounted in a safe and stable position allowing for cooling air circulation.

Do not operate equipment in an environment outside the laid down operating parameters.

The welding power source is not suitable for use in rain or snow.

Always store the machine in a clean, dry space.

Ensure the equipment is kept clean from dust build up.

Always use the machine in an upright position.

## Protection from moving parts

When the machine is in operation keep away from moving parts such as motors and fans.

Moving parts, such as the fan, may cut fingers and hands and snag garments.

Protections and coverings may be removed for maintenance and controls only by qualified personnel after first disconnecting the power supply cable.

Replace the coverings and protections and close all doors when the intervention is finished and before starting the equipment.

Take care to avoid getting fingers trapped when loading and feeding wire during set up and operation.

When feeding wire be careful to avoid pointing it at other people or towards your body.

Always ensure machine covers and protective devices are in operation.

## Risks due to magnetic fields



The magnetic fields created by high currents may affect the operation of pacemakers or electronically controlled medical equipment.

Wearers of vital electronic equipment should consult their physician before beginning any arc welding, cutting, gouging or spot welding operations.

Do not go near welding equipment with any sensitive electronic equipment as the magnetic fields may cause damage.

Keep the torch cable and work return cable as close to each other as possible throughout their length.

This can help minimise your exposure to harmful magnetic fields.

Do not wrap the cables around the body.

## Handling of compressed gas cylinders and regulators

### **Mishandling gas cylinders can lead to rupture and the release of high pressure gas.**

Always check the gas cylinder is the correct type for the welding to be carried out.

Always store and use cylinders in an upright and secure position.

All cylinders and pressure regulators used in welding operations should be handled with care.

Never allow the electrode, electrode holder or any other electrically “hot” parts to touch a cylinder.

Keep your head and face away from the cylinder valve outlet when opening the cylinder valve.

Always secure the cylinder safely and never move with regulator and hoses connected.

Use a suitable trolley for moving cylinders.

Regularly check all connections and joints for leaks.

Full and empty cylinders should be stored separately.

### **Never deface or alter any cylinder**

# SAFETY INSTRUCTION

## RF Declaration

Equipment that complies with directive 2014/30/EU concerning electromagnetic compatibility (EMC) and the technical requirements of EN60974-10 is designed for use in industrial buildings and not those for domestic use where electricity is provided via the low voltage public distribution system.

Difficulties may arise in assuring class A electromagnetic compatibility for systems installed in domestic locations due to conducted and radiated emissions.

In the case of electromagnetic problems, it is the responsibility of the user to resolve the situation.

It may be necessary to shield the equipment and fit suitable filters on the mains supply.

## LF Declaration

Consult the data plate on the equipment for the power supply requirements.

Due to the elevated absorbance of the primary current from the power supply network, high power systems affect the quality of power provided by the network. Consequently, connection restrictions or maximum impedance requirements permitted by the network at the public network connection point must be applied to these systems.

In this case, the installer or the user is responsible for ensuring the equipment can be connected, consulting the electricity provider if necessary.

## Materials and their disposal

Welding equipment is manufactured with BSI published standards meeting CE requirements materials which do not contain any toxic or poisonous materials dangerous to the operator.

Do not dispose of the equipment with normal waste. The European Directive 2012/19/EU on Waste Electrical and Electronic Equipment states the electrical equipment that has reached its end of life must be collected separately and returned to an environmentally compatible recycling facility for disposal.

**For more detailed information please refer to the HSE website [www.hse.gov.uk](http://www.hse.gov.uk)**



## PRODUCT OVERVIEW

The Jasic Compact MIG inverter range of welding machines have been designed as integrated and portable welding power supplies units incorporating the most advanced IGBT inverter technology in power electronics with easy operation and adjustment due to friendly user interface.

Unique electric structure and air channel design in this series of machines can speed up the heat dissipation of the power device as well as improving the duty cycles of the machines. The unique heat rejection efficiency of the air channel can effectively prevent the power devices and control circuits from being damaged by the dust absorbed by the fan and thereby, the reliability of the machine is greatly improved.

The whole machine is in form of coherent streamline, the front and rear panels are naturally integrated via large-radian transition manner. The front panel and the rear panel of the machine and the handle are coated with rubber oil, so the machine has soft texture, good hand feeling that feels warm and comfortable to hold.

### Jasic MIG 200CS Product Features:

- Advanced Synergic Control (Pulse parameters are selected automatically)
- Compact size, lightweight and modern 40kHz advanced IGBT design inverter
- Multi process MIG/MAG, MMA and Lift TIG welding functions are available
- The JM-200CS is a single phase 230V +/- 15% AC input machine
- Designed for gas & gasless MIG welding wires with additional features as wire inch and gas purge
- Suitable for 0.6/0.8/1.0mm MIG welding wire
- Self adaptive burnback control
- 2T/4T torch trigger facility
- Built in hot start arc ignition function which ensures excellent arc ignition in MMA for easier and more reliable arc starting
- Built in self adaptive arc force technology which maintains the optimum MMA arc conditions during operation even with long welding cables
- DC MMA suitable for a wide range of electrodes in MMA
- Advanced Lift arc ignition in TIG welding mode (Euro style TIG torch can be used)
- Excellent weld characteristics
- Auto compensation for mains voltage fluctuation
- Easy arc starting, low spatter, stable current which offers good weld bead shape
- High quality tactile finish to mouldings and handle
- Supplied with MIG Torch model T150-3, Gas regulator, Gas hose, Work return lead and clamp



## TECHNICAL SPECIFICATIONS

Parameter	Unit	Jasic MIG 200 Synergic (JM-200CS)
Rated input voltage	V	AC230V±15% 50/60Hz
Rated input power	kVA	9.4
Rated input current I <sub>max</sub>	A	35.6
Rated input current I <sub>eff</sub>	A	21
Welding current range	A	MIG 30 ~ 200 MMA 10 ~ 200 TIG 10 ~ 200
No-load voltage	V	53
Rated duty cycle (40°C)	%	MIG 200A @ 35% MMA 200A @ 35% TIG 200A @ 35%
Efficiency	%	84
Idle State Power	W	< 50
Power factor	cosφ	0.7
Standard	-	EN60974-1
Protection class	IP	IP21S
Insulation class	-	F
Noise	db	<70
Operating temperature range	°C	-10 ~ +40
Storage temperature	°C	-25 ~ +55
MIG recommended wire size	mm	0.6/0.8/1.0
Wire spool size	mm	200mm
MMA recommended electrode size	mm	1.6 ~ 5.0
Overall size	mm	485 X 185 X 370
Weight	Kg	12.8

### Please Note

Due to variations in manufactured products all claimed performance ratings, capacities, measurements, dimensions and weights quoted are approximate only. Achievable performance and ratings when in use can depend upon correct installation, applications and use along with regular maintenance and service.

# CONTROLS

## Front view Jasic MIG 200CS

1. Voltage digital display
2. Current digital display
3. MMA current and wire feed speed control dial
4. "-" Output terminal
5. Euro outlet for MIG torch
6. "+" Output terminal
7. 2T/4T torch trigger mode switch
8. Welding mode control switch
9. Voltage/arc force and downslope time control dial

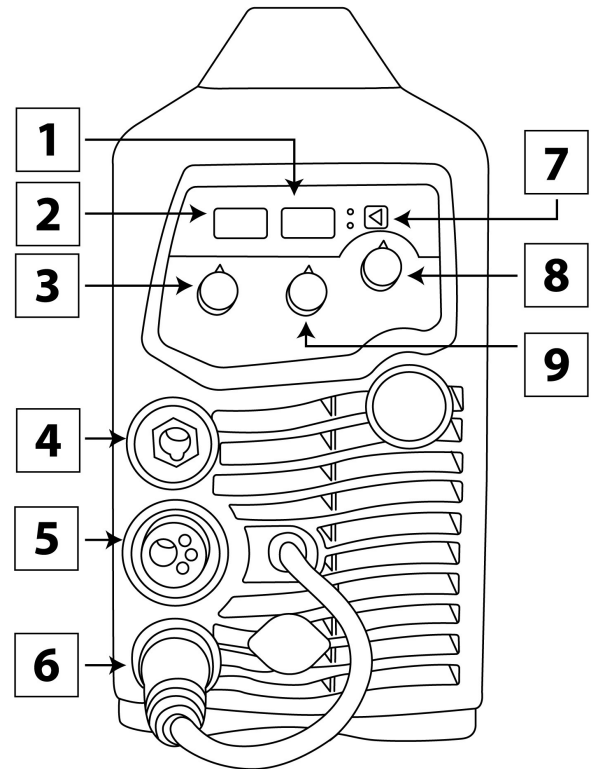

## Rear view Jasic MIG 200CS

10. Power switch: The ON/OFF mains switch for the machine
11. Gas inlet connection: The gas inlet that allows you to connect the gas supply from the gas regulator
12. Cooling fans: The entry for the air to access the cooling fans
13. Input cable gland: The entry for the mains power cable

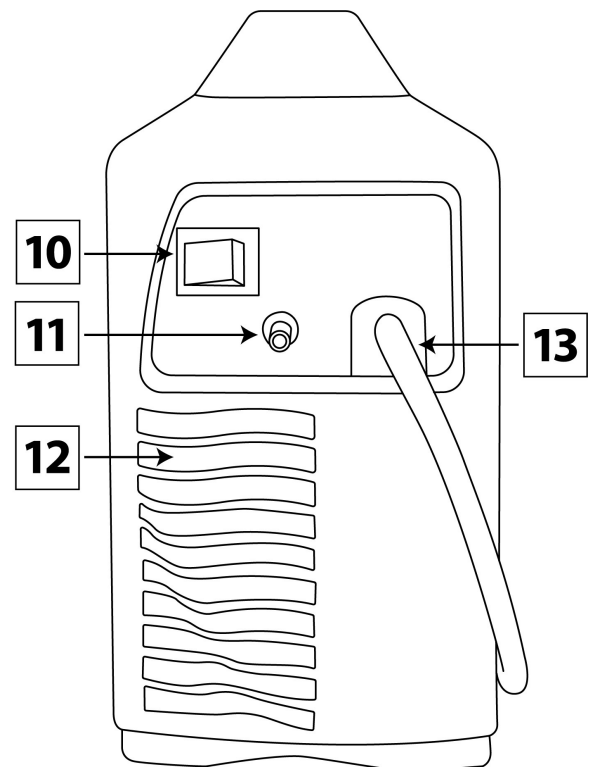

# CONTROLS

## Side view Jasic MIG 200CS

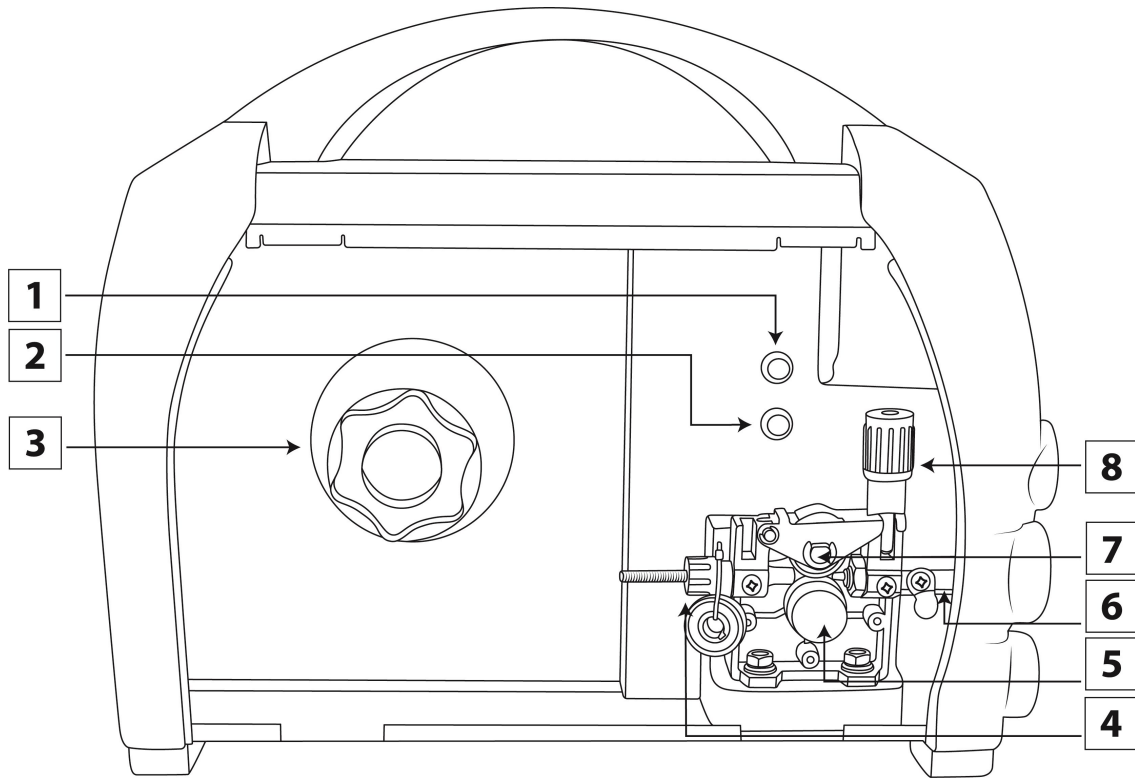

1. Wire inch button: Pressing this button activates the feed motor which in turn pushes the welding wire through the MIG torch and tip
2. Gas purge button: Pressing this button activates the gas solenoid which in turn activates the gas flow allowing you to correctly set the gas flow on the gas regulator
3. Wire spool holder and tensioner: Allows a 5Kg (200mm dia) reel of wire to be located in place via an alignment pin and then locked in place with the locking nut. The spool holder also has a brake arrangement to ensure correct tension of the wire, this is done by turning the central bolt with an Allen key clockwise (to tighten) or anti clockwise (to loosen)
4. Inlet wire guide: The welding wire is fed through the inlet guide prior to feeding through the drive rollers
5. Wire feed roller and retaining nut: Secures and holds the grooved drive roller in place
6. Outlet feed adaptor: Part of the Euro outlet connector which contains the inner outlet guide which ensures smooth wire feed from the drive assembly through to the MIG torch
7. Pressure roll assembly: Holds the upper drive roll in place which applies pressure to the welding wire onto the grooved drive roller
8. Drive roll tensioner: Allows the correct amount of tension to be applied to the top roller to ensure good feed of the wire through the MIG torch

# CONTROLS

## Front control panel view Jasic MIG 200CS

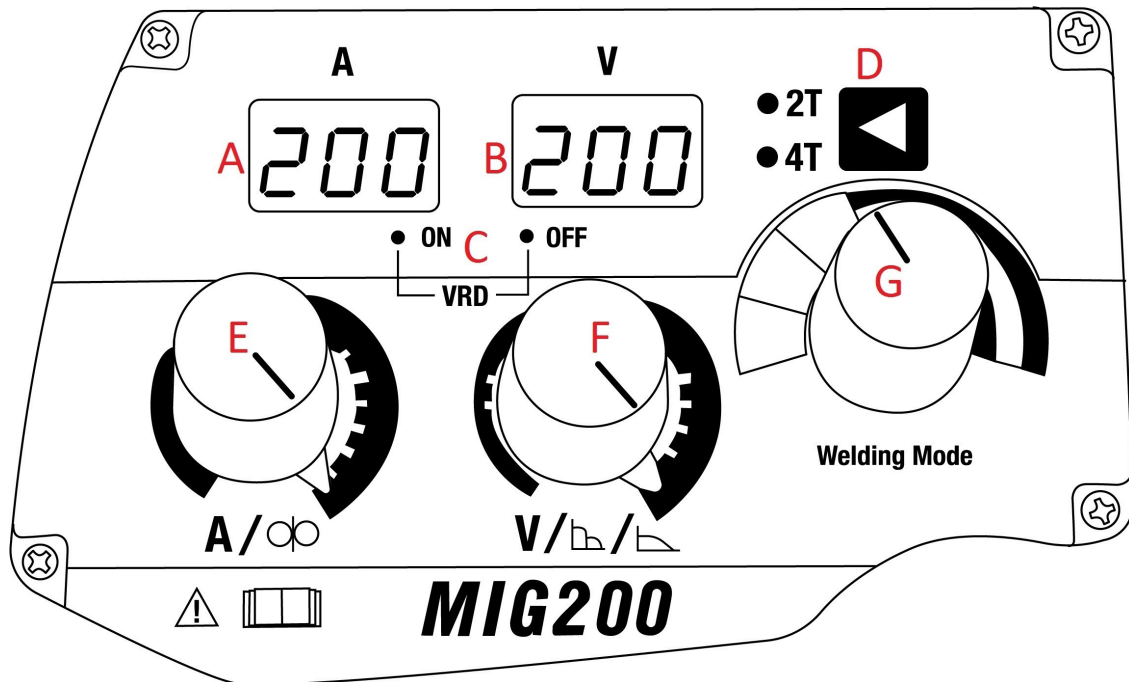

- A. Amperage digital display: Displays current when welding in either MIG and MMA mode. Please note, in MIG mode it will show the preset wire feed speed and then welding it will display amperage.
- B. Voltage digital display: Displays MIG and MMA voltage when welding. Please note that these displays are also used to show error codes, See page 42 for further details.
- C. VRD indicator: VRD is an optional facility on the MIG 200CS, please speak to your supplier for further details.
- D. 2T/4T selection switch: This option allows the user to switch between 2T (2 stroke) 4T (4 stroke/latch). In 2T mode the weld will start and continue while the trigger is pressed. In 4T mode once the welding arc has started can you then release the trigger and welding will continue until the trigger is activated again.
- E. Amperage and wire feed speed control: This dial has 2 functions, when in MMA mode it adjusts the amount of welding current delivered by the power source and in MIG mode it adjusts the rate of speed (metre per minute) at which the filler metal is fed and consumed in the weld, which in turn adjusts the output current by varying the amount of MIG wire delivered to the welding arc. See set up chart on page 29 for further information.
- F. Voltage, arc force and downslope time control dial: Welding voltage can be adjusted in MIG mode only and will increase or decrease the output voltage to assist in finding the optimum voltage level required dependent on the wire feed, wire size and application being undertaken, see set up chart on page 29.  
Arc force: Functions during welding, when the machine senses a short circuit it will offer more current to help stabilize the welding arc, this will prevent the arc from cutting out while welding as well as preventing the electrode from sticking.  
Downslope time: Used in the TIG mode and indicates the time spent on current dropping from the preset value to 10 amps and is set according to users' welding requirements.
- G. Welding mode selector switch: This 7 position switch allows the user to switch between MMA, TIG, MIG and synergic MIG welding modes. See page 14 for further information.

# CONTROLS

## Welding mode function switch explained Jasic MIG 200CS

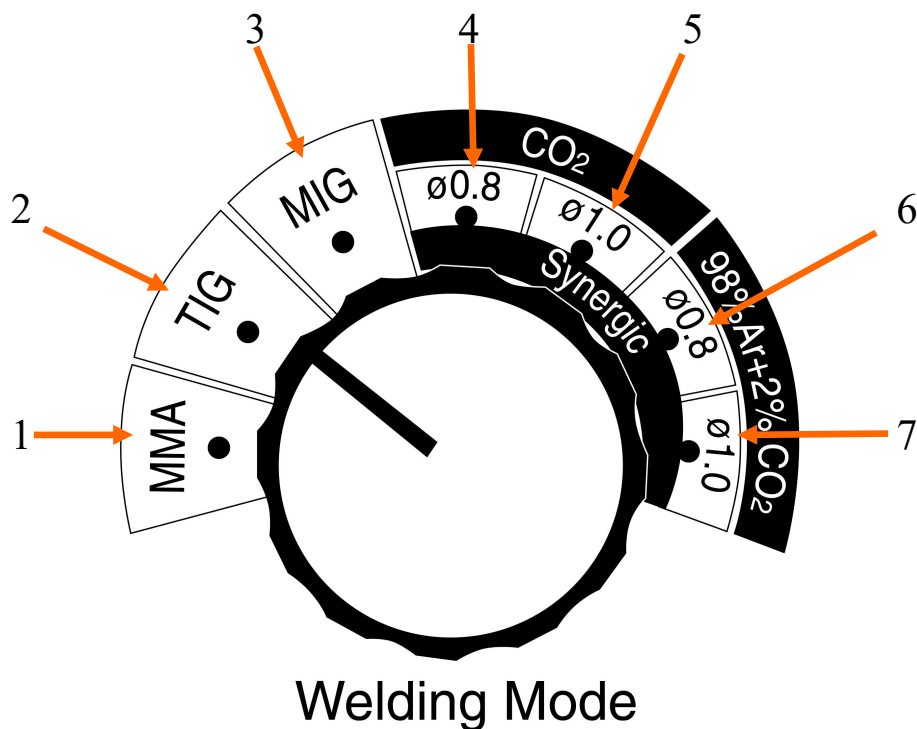

The welding mode dial is a 7 position switch which allows the users to select the different weld processes.

1. MMA - MMA welding process position
2. TIG - Lift TIG welding process position
3. MIG - Standard MIG welding process position

### Synergic MIG Mode:

4. CO<sup>2</sup> / 0.8 - In this position you have entered synergic MIG mode for 0.8mm dia welding wire when being used with CO<sup>2</sup> gas
5. CO<sup>2</sup> / 1.0 - In this position you have entered synergic MIG mode for 1.0mm dia welding wire when being used with CO<sup>2</sup> gas
5. 98% Ar + 2% CO<sup>2</sup> / 0.8 - In this position you have entered synergic MIG mode for 0.8mm dia welding wire when being used with gas mixture of 98% Argon and 2% CO<sup>2</sup>
6. 98% Ar + 2% CO<sup>2</sup> / 1.0 - In this position you have entered synergic MIG mode for 1.0mm dia welding wire when being used with gas mixture of 98% Argon and 2% CO<sup>2</sup>

The inbuilt synergic control is used in this Jasic MIG 200CS in which the voltage is adjusted in relation to the wire feed speed, so when in synergic mode the volts and wire feed speed are linked and altering the wire feed speed dial will alter each characteristic in-keeping with the welding curve.

Adjusting the voltage dial will trim the voltage but also adjust the wire feed speed accordingly.

# MULTIFUNCTIONAL DISPLAY WINDOW

The digital displays on the Jasic MIG 200CS have multiple purposes as described below:



During welding, the current display window displays the practical welding current value, and the voltage display window displays the practical welding voltage value. In standby mode, the windows display as follows.

Welding Mode	Current display window	Voltage display window
MMA	Preset Current (A)	VRD voltage (V) / arc force (A/MS) *
MIG	Preset wire feed speed (m/min)	Preset voltage (V)
TIG	Preset current (A)	Downslope time (S)

\* It displays VRD voltage when not turning the voltage control knob, and displays the arc force when turning the voltage control knob.

## System parameters setting

This machine uses a group of welding parameters in common use as default. If the user wants to alter these parameters, he or she can realize this by altering the system parameters.

The method to alter the system parameter is as follows:

- 1) Press the 2T/4T switch key on the panel and do not release it. Then, turn on the power switch of the welding machine.
- 2) When the display window displays “--- ---”, release the 2T/4T switch key to enter into the system parameter adjusting interface.
- 3) Select the welding mode which needs adjusting by turning the welding mode select switch, select the parameter number through the current control knob, and select the parameter value through the voltage control knob.

Please refer to the table below for the contents of system parameters.

	MMA	MIG	TIG
P1	Ignition current (A)	Crater fill speed (m/min)	Initial current (A)
P2	Ignition time (S)	Crater fill voltage (V)	Pilot arc current (A)
P3	Capacity setting (A)	Downslope time (S)	Upslope time (S)
P4	Reset to default settings (0:No; 1:Yes)	Pre-flow time (S)	Pre-flow time (S)
P5		Post-flow time (S)	Post-flow time (S)

- 4) After the parameter adjustment is done, press the 2T/4T switch key again to store the system parameters. Then, the machine enters into standby mode.

# INSTALLATION

## Unpacking

Check the packaging for any signs of damage.

Carefully remove the machine and retain the packaging until the installation is complete.

## Location

The machine should be located in a suitable position and environment. Care should be taken to avoid moisture, dust, steam, oil or corrosive gases.

Place on a secure level surface and ensure that there is adequate clearance around the machine to ensure natural airflow.

## Input connection

Before connecting the machine you should ensure that the correct supply is available. Details of the machine requirements can be found on the data plate of the machine or in the technical parameters shown in the manual.

The equipment should be connected by a suitably qualified competent person. Always ensure the equipment has a proper grounding.

Never connect the machine to the mains supply with the panels removed.

## Output connections

### Electrode polarity

In general when using manual arc welding electrodes the electrode holder is connected to the positive terminal and the work return to the negative terminal. Always consult the electrode manufacturer's data sheet if you have any doubts.

### MMA welding

Insert the cable plug with electrode holder into the "+" socket on the front panel of the welding machine and tighten it clockwise.

Insert the cable plug of the work return lead into the "-" socket on the front panel of the welding machine and tighten it clockwise.

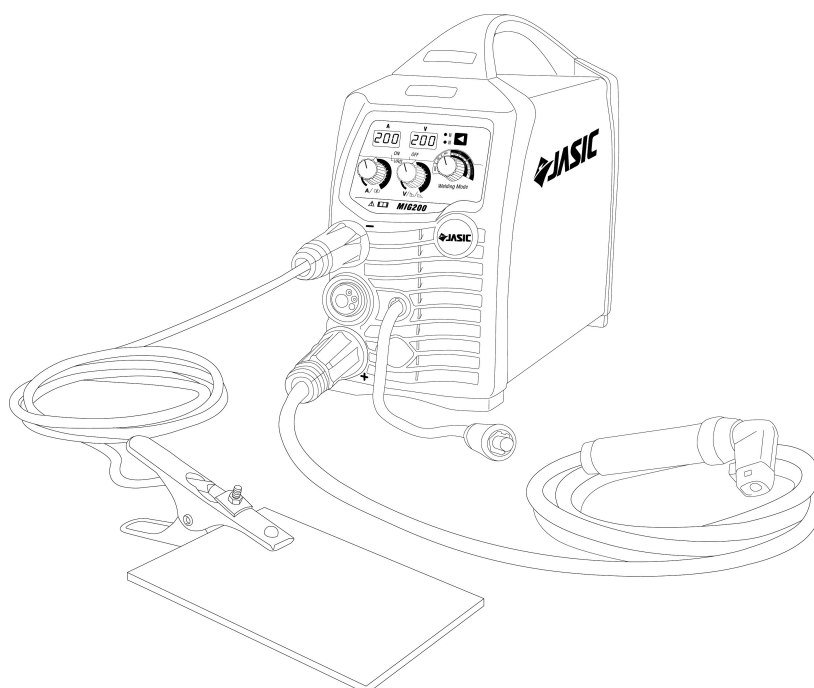



# INSTALLATION

## MIG welding

Insert the welding torch into the “Euro connector for torch in MIG” output socket on the front panel of the machine and tighten it.

Insert the trailing cable plug (A) into the “+” output terminal of the welding machine, and tighten it clockwise.

Insert the work return lead cable plug (B) into the “-” output terminal on the front panel of the welding machine and tighten it clockwise.

Install the welding wire on the spindle adapter.

Connect the cylinder equipped with the gas regulator to the gas inlet on the back panel of the machine with a gas hose.

Ensure that the groove size in the feeding position on the drive roll matches the contact tip size of the welding torch and the wire size being used.

Release the pressure arm of the wire feeder to thread the wire through the guide tube and into the drive roll groove and then adjust the pressure arm, ensuring no sliding of the wire. (too much pressure will lead to wire distortion which will affect wire feeding).

Place the welding mode switch into the MIG position.

Press the wire inch button to thread the wire out of the torch through the contact tip.

You are now ready to start MIG welding.

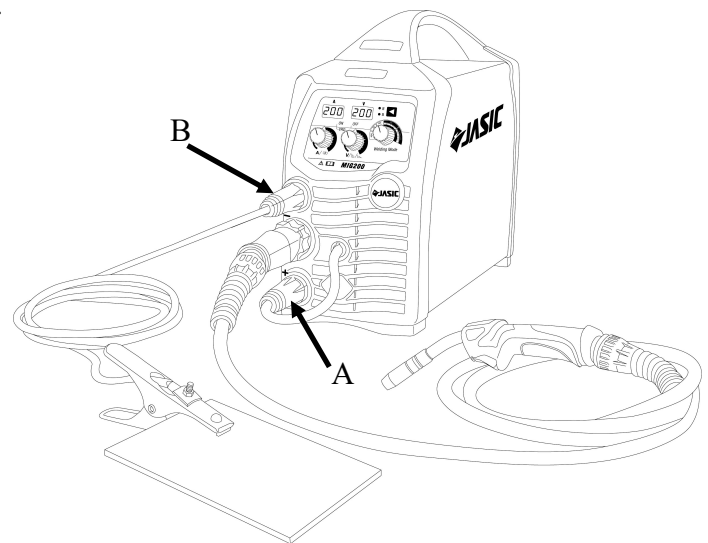

## Gasless self shielded MIG welding

Insert the welding torch into the “Euro connector for torch in MIG” output socket on the front panel of the machine and tighten it.

Insert the work return cable plug (C) into the “+” output terminal of the welding machine and tighten it clockwise.

Insert the trailing cable plug (D) into the “-” output terminal on the front panel of the welding machine and tighten it clockwise.

Install the wire spool on the spindle adapter, ensuring that the groove size in the feeding position on the drive roll matches the contact tip size of the welding torch and the wire size being used.

Release the pressure arm of the wire feeder to thread the wire through the guide tube and into the drive roll groove.

Adjust the pressure arm ensuring no sliding of the wire (too much pressure will lead to wire distortion which will affect wire feeding).

Place the welding mode switch into the MIG position.

Press the wire inch button to thread the wire out of the torch through the contact tip.

You are now ready to start gasless MIG welding.

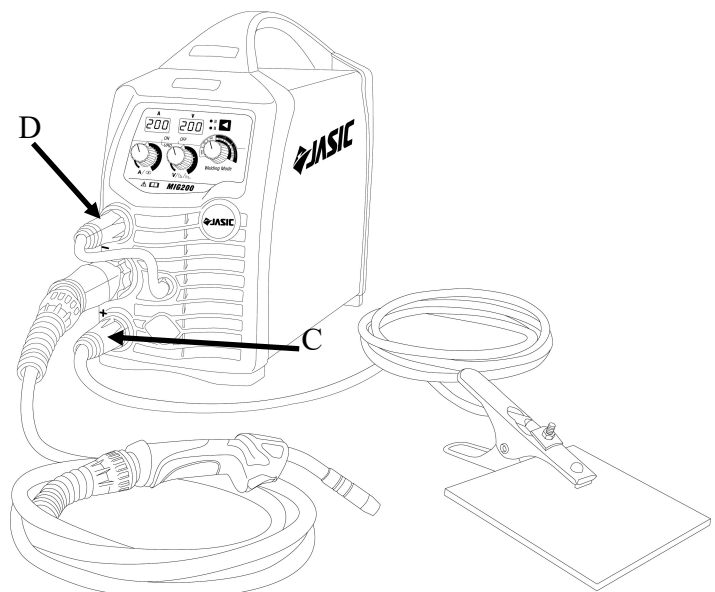

# OPERATION - MMA



Before starting any welding activity ensure that you have suitable eye protection and protective clothing. Also take the necessary steps to protect any persons within the welding area.

## MMA welding mode

MMA (Manual Metal Arc), SMAW (Shielded Metal Arc Welding) or just Stick Welding.

Stick welding is an arc welding process which melts and joins metals by heating them with an arc between a covered metal electrode and the work.

Shielding is obtained from the electrode outer coating, often called flux. Filler metal is primarily obtained from the electrode core.

The electrodes outer coating called flux assists in creating the arc and provides a shielding gas and on cooling forms a slag covering to protect the weld from contamination.

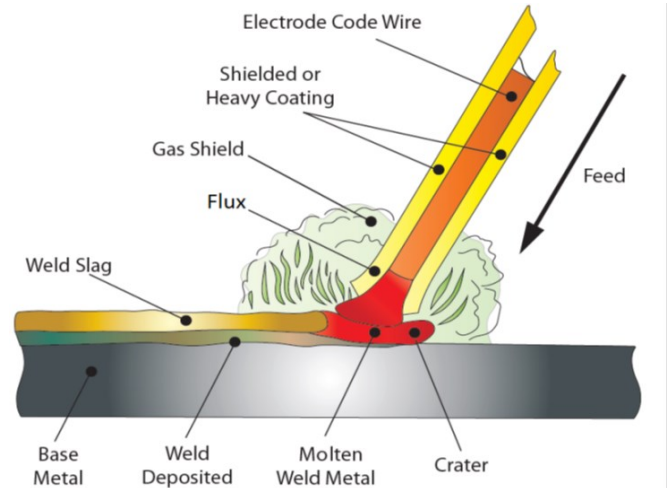

When the electrode is moved along the work piece at the correct speed the metal core deposits a uniformed layer called the weld bead.

After connecting the welding leads as detailed you will need to switch the power switch on the back panel to "ON".

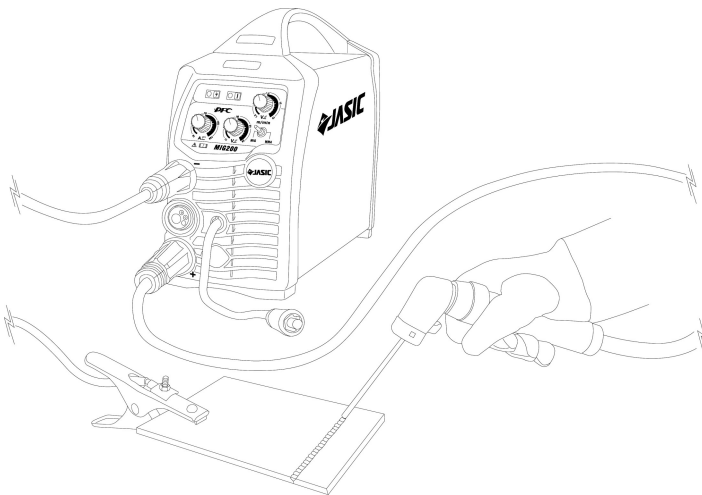

Using the welding mode switch, select MMA by switching to the MMA position. There is now open circuit voltage output at both output terminals.

Ensure you check that you have the electrode polarity correct.

Set the amperage on the machine suitable for the electrode being used.

Please see a guide to amperages required, although This MMA welding electrode guide can vary depending on material, work piece thickness, welding position and joint form.

Electrode Diameter (mm)	Recommended Welding Current (A)
1.6	25 ~ 45
2.0	35 ~ 65
2.5	50 ~ 90
3.2	60 ~ 130
4.0	100 ~ 180
5.0	150 ~ 250
6.0	200 ~ 310

# OPERATION - MIG/MAG



Before starting any welding activity ensure that you have suitable eye protection and protective clothing. Also take the necessary steps to protect any persons within the welding area.

## MIG/MAG welding mode

MIG - Metal Inert Gas Welding, MAG - Metal Active Gas Welding, GMAW - Gas Metal Arc Welding

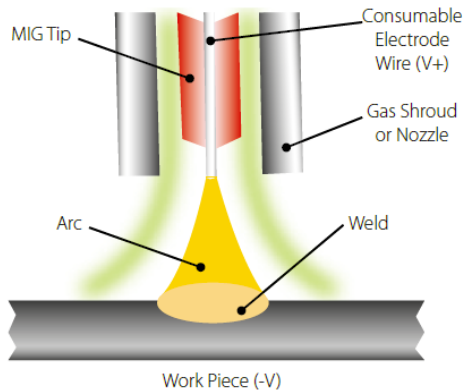

MIG welding was developed to help meet production demands of the war and post war economy which is an arc welding process in which a continuous solid wire electrode is fed through a MIG welding gun and into the weld pool, joining the two base materials together.

A shielding gas is also sent through the MIG welding gun and protects the weld pool from contamination which also enhances the arc.

Connect the MIG torch leads as detailed on page 17. Work return lead to '-' (B) and the torch trailing lead to '+' (A)

Ensure that a suitable inert gas supply is connected.

Switch the power switch on the back panel to "ON" the machine is started with the power LED on and the fans are running.

Using the welding mode switch, select MIG by switching to the MIG position.

Open the gas valve of the cylinder and adjust the gas regulator to obtain the desired flow rate.

Adjust the "voltage control knob in MIG" and "wire feed speed control knob in MIG" on the front panel of the machine to get the correct welding voltage and welding current.

Operate the torch trigger and welding can be carried out.

The below MIG wire guide can vary depending on material used, work piece thickness, welding position and joint form.

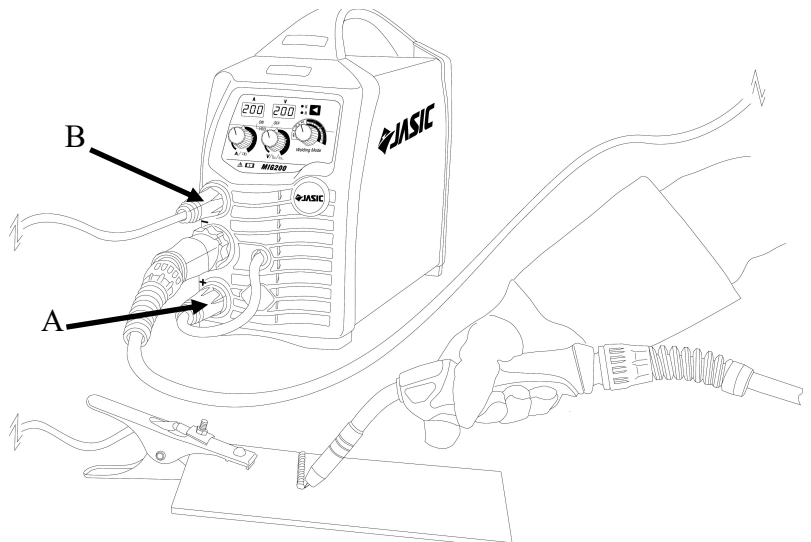

Wire Diameter (mm)	DIP Transfer		Spray Transfer	
	Current (A)	Voltage (V)	Current (A)	Voltage (V)
0.6	30 ~ 80	15 ~ 18	n/a	n/a
0.8	45 ~ 180	16 ~ 21	150 ~ 250	25 ~ 33
1.0	70 ~ 180	17 ~ 22	230 ~ 300	26 ~ 35
1.2	60 ~ 200	17 ~ 22	250 ~ 400	27 ~ 35
1.6	100 ~ 280	18 ~ 22	250 ~ 500	30 ~ 40

## MIG - Gasless

The operation method is the same as the above MIG operation except there are no gas options and the output polarity is reversed (see page 17).

## OPERATION - TIG



**Before starting any welding activity ensure that you have suitable eye protection and protective clothing. Also take the necessary steps to protect any persons within the welding area.**

### TIG welding mode

Terms used: TIG – Tungsten Inert Gas, GTAW – Gas Tungsten Arc Welding.

TIG welding is an arc welding process that uses a non-consumable tungsten electrode to produce the heat for welding.

The weld area is protected from atmospheric contamination by a shielding gas (usually an inert gas such as argon or helium) and a filler rod matching the base material is normally used, though some welds, known as autogenous welds, are carried out without the need for filler wire.

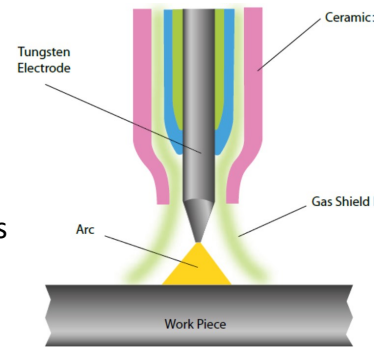

The Jasic 200CS when used in Lift TIG mode can accommodate the use of a Euro style TIG torch.

Connect the TIG torch to the (MIG) Euro connector. Ensure the trailing lead is connected into the “-” socket on the front panel of the machine and fully tightened clockwise.

Insert the cable plug for the work clamp into the “+” socket on the front panel of the welding machine and fully tightened clockwise.

Connect the gas hose to the regulator/flowmeter located on the shield gas cylinder and connect the other end to the machine.

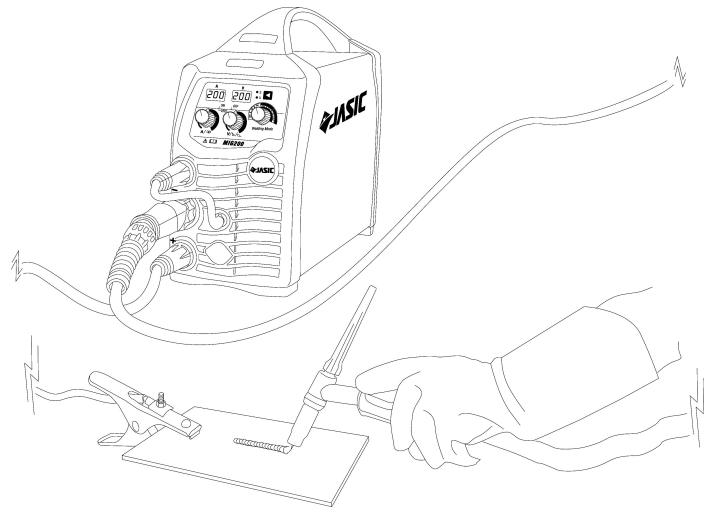

**Before starting any welding activity ensure that you have suitable eye protection and protective clothing. Also take the necessary steps to protect any persons within the area.**

Now you will need to switch the power switch on the back panel to “ON” and then select TIG mode by switching the welding mode dial to TIG.

Set the amperage on the machine suitable for the application and tungsten being used. (see below guide).

Ensure you have adequate welding current according to the thickness of the work and weld prep being carried out and filler wire being used.

Tungsten Size	DC – Electrode Negative
1.0mm	15 – 80A
1.6mm	70 – 150A
2.4mm	150 – 250A
3.2mm	250A – 400A

Open the gas valve of the cylinder, press the torch trigger and adjust the gas regulator to obtain the desired flow rate.

Once welding is complete release the torch trigger switch which will stop the welding arc but ensure you leave the torch in place to shield the weld with gas for a few seconds until the preset post flow gas turns off.

# GUIDE TO MMA WELDING



**Before starting any welding activity ensure that you have suitable eye protection and protective clothing. Also take the necessary steps to protect any persons within the welding area.**

## Notes for the welding beginner

This section is designed to give the beginner who has not yet done any welding some information to get them going. The simplest way to start is to practice by running weld beads on a piece of scrap plate. Start by using mild steel (paint free) plate of 6.0mm thick and using 3.2mm electrodes. Clean any grease, oil and loose scale from the plate and fix firmly to your work bench so that welding can be carried out. Make sure that the work return clamp is secure and making good electrical contact with the mild steel plate, either directly or through the work table. For best results always clamp the work lead directly to the material being welded, otherwise a poor electrical circuit may create itself.

## Welding position

When welding, ensure you place yourself in a comfortable position for welding and your welding application before you begin to weld. This maybe sitting at a suitable height which often is the best way to weld ensuring you're relaxed and not tense. A relaxed posture will ensure the welding task becomes much easier.

Please ensure you always wear suitable PPE and use suitable fume extraction when welding.

Place the work so that the direction of welding is across, rather than to or from your body. The electrode holder lead should always be clear of any obstruction so that you can move your arm freely along as the electrode burns down. Some elders prefer to have the welding lead over their shoulder, this allows greater freedom of movement and can reduce the weight from your hand.

Always inspect your welding equipment, welding cables and electrode holder before each use to ensure it's not faulty or worn as you may be at risk of an electric shock.

## MMA process features and benefits

The versatility of the process and the skill level required to learn, basic simplicity of the equipment make the MMA process one of the most common used throughout the world.

The MMA process can be used to weld a wide variety of materials and is normally used in the horizontal position but can be used in vertical or overhead with the correct selection of electrode and current. In addition, it can be used to weld at long distances from the power source subject to the correct cable sizing. The self shielding effect of the electrode coating makes the process suitable for welding in external environments. It is the dominant process used in maintenance and repair industries and is used extensively in structural and fabrication work.

The process is well able to cope with less than ideal material conditions such as dirty or rusty material. Disadvantages of the process are the short welds, slag removal and stop/starts which lead to poor weld efficiency which is in the region of 25%. The weld quality is also highly dependent on the skill of the operator and many welding problems can exist.

# GUIDE TO MMA WELDING



Before starting any welding activity ensure that you have suitable eye protection and protective clothing. Also take the necessary steps to protect any persons within the welding area.

## MMA process tips and guides

### Typical welder set up

1. Electrode holder
2. Work return clamp
3. Work piece
4. Weld material covered by electrode flux or slag
5. Electrode
6. Distance from work to electrode (arc Length)

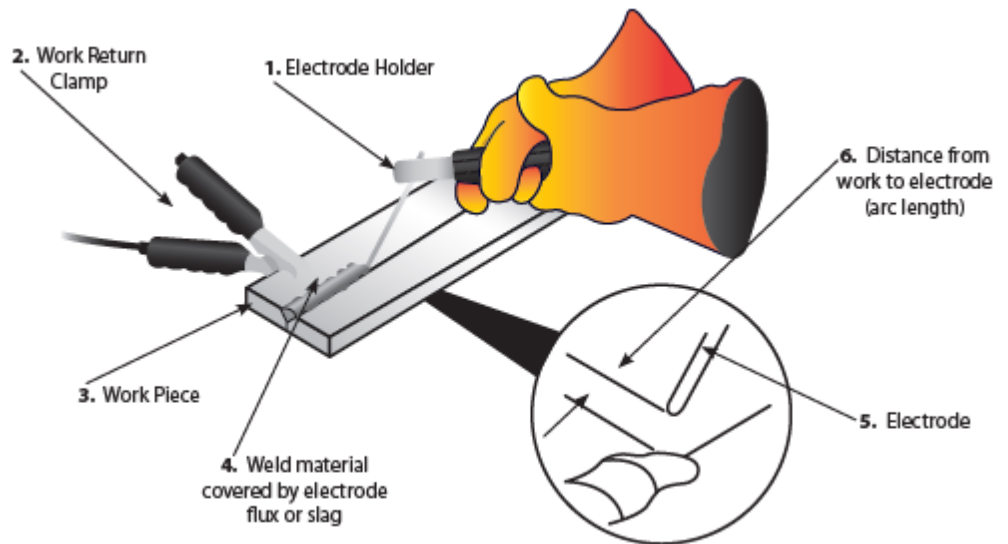

Welding current will flow in the circuit as soon as the electrode contacts the work piece. The welder should always ensure a good connection of the work clamp. The nearer the clamp is placed to the welding area the better.

When the arc is struck the distance between the end of the electrode and the work will determine the arc voltage and also affect the weld characteristic. As a guide the arc length for electrodes up to 3.2mm diameter should be around 1.6mm and over 3.2mm around 3mm.

Upon completion of the weld the welding flux or slag will need to be removed usually with a chipping hammer and wire brush.

### Joint form in MMA

In MMA welding, the common basic joint forms: butt joint, corner joint, lap joint & T joint.

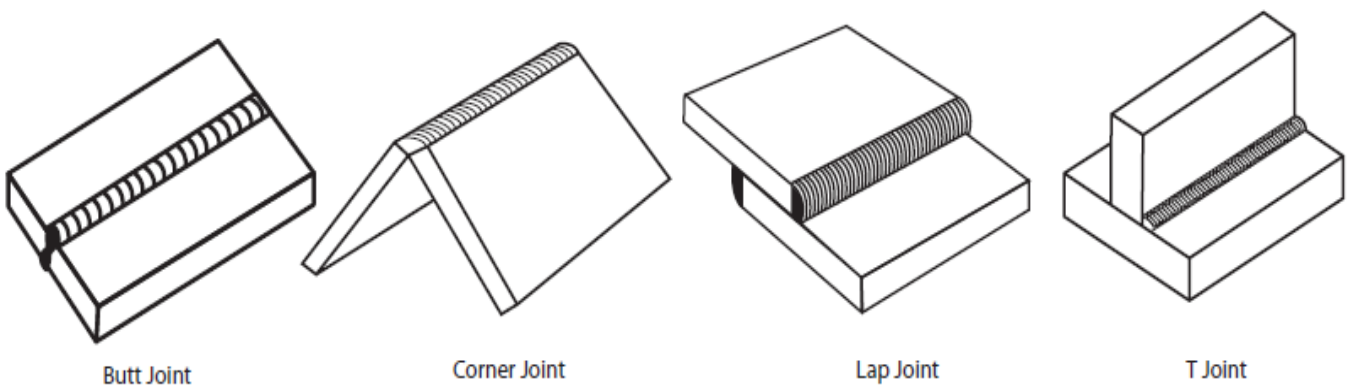

Butt Joint

Corner Joint

Lap Joint

T Joint

# GUIDE TO MMA WELDING



Before starting any welding activity ensure that you have suitable eye protection and protective clothing. Also take the necessary steps to protect any persons within the welding area.

## MMA arc striking

**Tap technique** - Lift the electrode upright and bring it down to strike the work piece. After forming short circuit, quickly lift up about 2~4mm and arc will be ignited. This method is difficult to master.

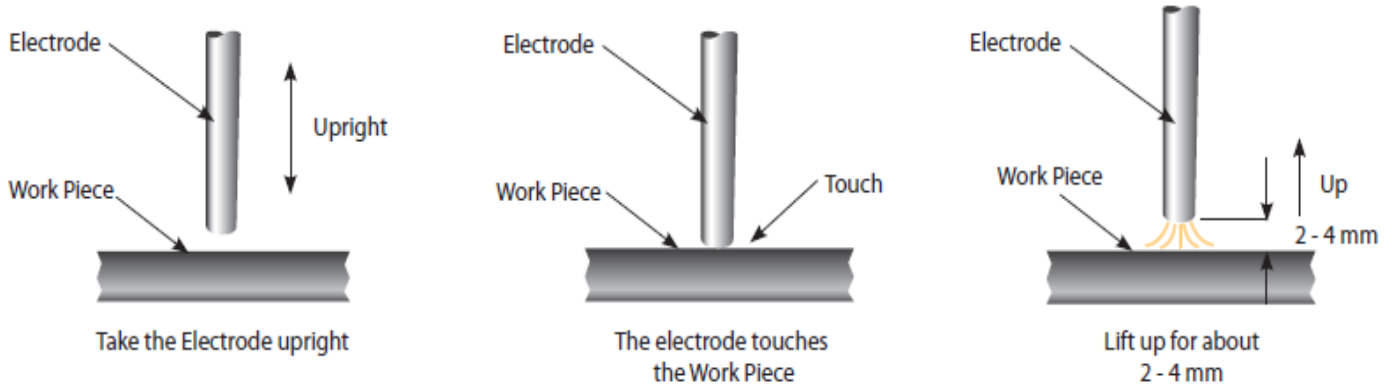

**Scratch technique** - Drag the electrode and scratch the work piece as if striking a match. Scratching the electrode may cause the arc to burn along the scratch path, so care should be taken to scratch in the weld zone. When the arc is struck adopt the correct welding position.

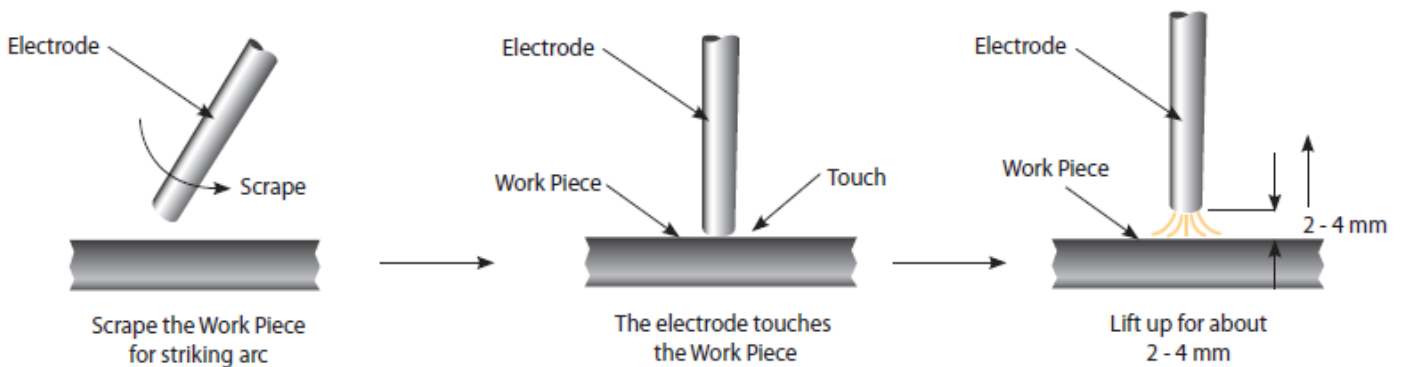

## Electrode positioning

### Horizontal or flat position

The electrode should be positioned at right angles to the plate and inclined in the direction of travel at around 10°-30°.

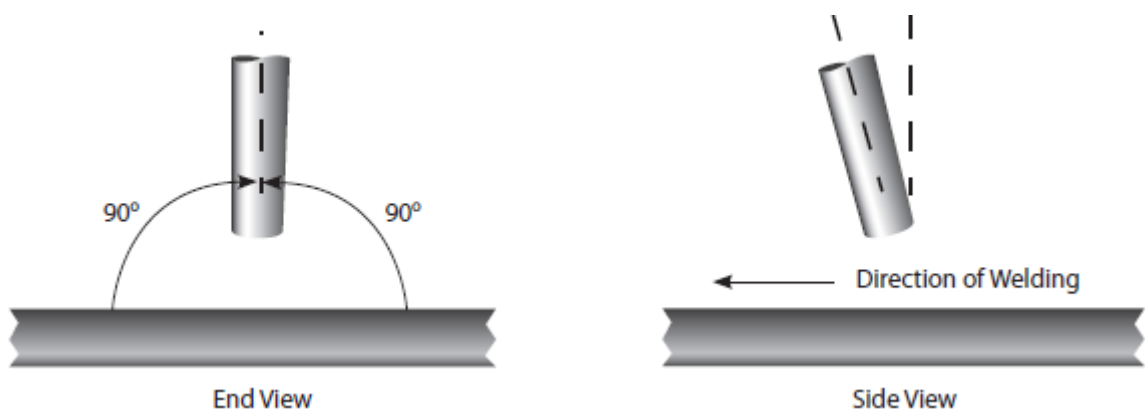

# GUIDE TO MMA WELDING



Before starting any welding activity ensure that you have suitable eye protection and protective clothing. Also take the necessary steps to protect any persons within the welding area.

## Fillet welding

The electrode should be positioned to split the angle i.e.  $45^\circ$ . Again the electrode should be inclined in the direction of travel at around  $10^\circ$ - $30^\circ$ .

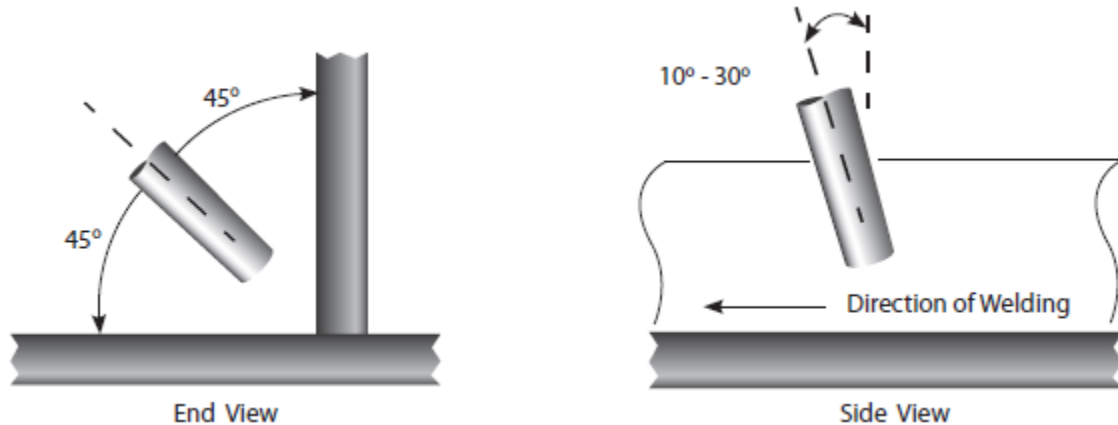

## Manipulation of electrode

In MMA welding there are three motions used at the end of electrode:

1. The electrode feeding to the molten pool along axes
2. The electrode swing right and left
3. The electrode moving in the weld direction

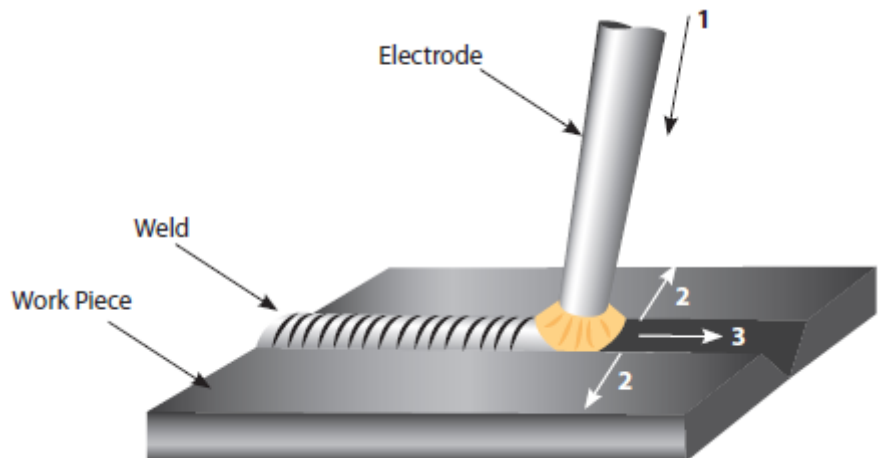

The operator can choose the manipulation of electrode based on welding joint, welding position, electrode spec, welding current and operation skill etc.

## Weld characteristics

A good weld bead should exhibit the following characteristics:

1. Uniform weld bead
2. Good penetration into the base material
3. No overlap
4. Fine spatter level

A poor weld bead should exhibit the following characteristics:

1. Uneven and erratic bead
2. Poor penetration into the base material
3. Bad overlap
4. Excessive spatter levels
5. Weld crater



# MMA WELDING PROBLEMS



Before starting any welding activity ensure that you have suitable eye protection and protective clothing. Also take the necessary steps to protect any persons within the welding area.

## Arc welding defects and prevention methods

<u>Defect</u>	<u>Possible cause</u>	<u>Action</u>
Excessive spatter (beads of metal scattered around the weld area)	Amperage too high for the selected electrode	Reduce amperage or utilise larger diameter electrode
	Voltage too high or arc length too long	Reduce arc length or voltage
Uneven and erratic weld bead and direction	Weld bead is inconsistent and misses joint due to operator	Operator training required
Lack of penetration – The weld bead fails to create complete fusion between material to be welded, often surface appears okay but weld depth is shallow	Poor joint preparation	Joint design must allow for full access to the root of the weld
	Insufficient heat input	Material too thick Increase the amperage or increase the electrode size and amps
	Poor weld technique	Reduce travel speed Ensure the arc is on the leading edge of the weld puddle
Porosity – Small holes or cavities on the surface or within the weld material	Work piece dirty	Remove all contaminant from the material i.e. oil, grease, rust, moisture prior to welding
	Electrode is damp	Replace or dry the electrode
	Arc length is excessive	Reduce the arc length
Excessive penetration – The weld metal is below the surface level of the material and hangs below	Heat input too high	Reduce the amperage or use a smaller electrode and lower amperage
	Poor weld technique	Use correct welding travel speed
Burning through – Holes within the material where no weld exists	Heat input too high	Use lower amperage or smaller electrode Use correct welding travel speed
Poor fusion – Failing of weld material to fuse either with the material to be welded or previous weld beads	Insufficient heat level	Increase the amperage or increase the electrode size and amperage
	Poor welding technique	Joint design must allow for full access to the root of the weld Alter welding technique to ensure penetration such as weaving, arc positioning or stringer bead technique
	Work piece dirty	Remove all contaminant from the material i.e. oil, grease, rust, moisture prior to welding

# GUIDE TO MIG/MAG WELDING



Before starting any welding activity ensure that you have suitable eye protection and protective clothing. Also take the necessary steps to protect any persons within the welding area.

## Notes for the welding beginner

This section is designed to give the beginner who has not yet done any welding some information to get them going. The simplest way to start is to practice by running weld beads on a piece of scrap plate. Start by using mild steel (paint free) plate of 6.0mm thick and using 0.8mm wire. Clean any grease, oil and loose scale from the plate and fix firmly to your work bench so that welding can be carried out.

Make sure that the work return clamp is secure and making good electrical contact with the mild steel plate, either directly or through the work table. For best results always clamp the work lead directly to the material being welded, otherwise a poor electrical circuit may create itself.

## MIG/MAG process features and benefits

Terms used: MIG - Metal Inert Gas Welding,  
MAG - Metal Active Gas Welding,  
GMAW - Gas Metal Arc Welding

MIG welding was developed to help meet production demands of the war and post war economy which is an arc welding process in which a continuous solid wire electrode is fed through a MIG welding gun and into the weld pool, joining the two base materials together. A shielding gas is also sent through the MIG welding gun and protects the weld pool from contamination which also enhances the arc.

The MIG/MAG process can be used to weld a wide variety of materials and is normally used in the horizontal position but can be used in vertical or overhead with the correct selection of machine, wires and current. In addition, it can be used to weld at long distances from the power source subject to the correct cable sizing.

It is the dominant process used in maintenance and repair industries and is used extensively in structural and fabrication work.

Weld quality is also highly dependent on the skill of the operator and many welding problems can exist due to incorrect installation application and use.

## Welding position

When welding, ensure you place yourself in a comfortable position for welding and your welding application before you begin to weld. This maybe sitting at a suitable height which often is the best way to weld ensuring you're relaxed and not tense. A relaxed posture will ensure the welding task becomes much easier.

Please ensure you always wear suitable PPE and use suitable fume extraction when welding.

Place the work so that the direction of welding is across, rather than to or from your body. The electrode holder lead should always be clear of any obstruction so that you can move your arm freely along as the electrode burns down. Some welders prefer to have the welding lead over their shoulder, this allows greater freedom of movement and can reduce the weight from your hand.

Always inspect your welding equipment, welding cables and electrode holder before each use to ensure it's not faulty or worn as you may be at risk of an electric shock.

# GUIDE TO MIG/MAG WELDING



Before starting any welding activity ensure that you have suitable eye protection and protective clothing. Also take the necessary steps to protect any persons within the welding area.

## MIG process description

The MIG process was first patented for the welding of aluminium in 1949 in the USA.

The process uses the heat that is generated by an electric arc formed between a bare consumable wire electrode and the work piece.

This arc is shielded by a gas to prevent oxidation of the weld.

In the MIG process an inert shielding gas is used to protect the electrode and weld pool from contamination and enhance the arc. Originally this gas was helium.

In the early 1950's the process became popular in the UK for welding aluminium using argon as the shielding gas.

Development in the use of different gases resulted in the MAG process. This is where other gases were used, for example, carbon dioxide and sometimes users refer to the process as CO2 welding. Gases such as oxygen and carbon dioxide were added and are active constituents to the inert gas to improve the welding performance. Although the MAG process is in common use today it is still referred to as MIG welding although technically this is not correct. The process began to prove itself as an alternative to stick electrode (MMA) and TIG (GTAW) offering high productivity and deposition rates. The process also helps reduce any weld defects from the increased stop/starts used in MMA. However, the welder must have a good knowledge of the system set up to achieve satisfactory welds.

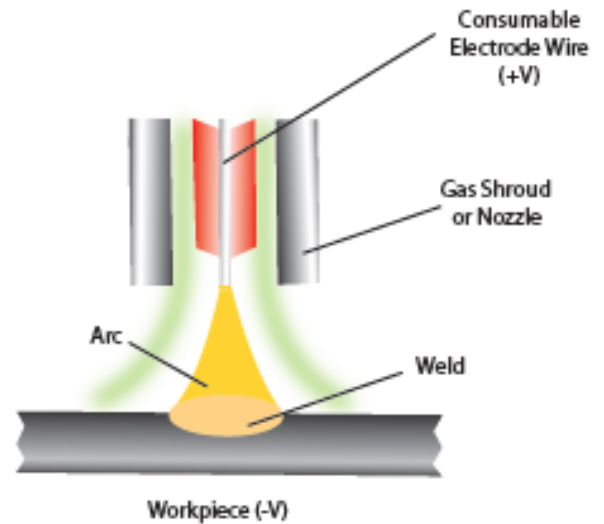

The electrode MIG gun is normally +VE and the work return is normally -VE. However, certain consumable wires sometimes require what is called reverse polarity i.e. Electrode -VE or work +VE. Typical of these types of wire are cored wires used in hard facing or high deposition and gasless applications.

## Typical welding ranges

Wire Diameter (mm)	DIP Transfer		Spray Transfer	
	Current (A)	Voltage (V)	Current (A)	Voltage (V)
0.6	30 ~ 80	15 ~ 18	n/a	n/a
0.8	45 ~ 180	16 ~ 21	150 ~ 250	25 ~ 33
1.0	70 ~ 180	17 ~ 22	230 ~ 300	26 ~ 35
1.2	60 ~ 200	17 ~ 22	250 ~ 400	27 ~ 35
1.6	100 ~ 280	18 ~ 22	250 ~ 500	30 ~ 40

# GUIDE TO MIG/MAG WELDING



Before starting any welding activity ensure that you have suitable eye protection and protective clothing. Also take the necessary steps to protect any persons within the welding area.

## MIG controls

The controls for the MIG/MAG system are as follows. Controls can be electro mechanical or electronic but the effects will be the same.

### Wire feed speed

The wire speed is directly related to the current. The higher the wire speed the more wire is deposited and hence more current is required to burn off the consumable wire.

Wire speed is measured in m/min (metres per min) or sometimes in ipm (inches per minute).

The diameter of the wire also forms part of the current demand e.g. a 1.0mm wire feeding at 3m per min will require less current than a 1.2mm wire feeding at the same rate.

The wire feed is set according to the material to be welded.

If the wire feed rate is too high in comparison to the voltage then a “stubbing” effect happens where unmelted consumable contacts the work piece creating large amounts of weld spatter.

Too little wire feed comparison to the voltage will result in a long arc being created with poor transfer and eventual burning back of the wire onto the contact tip.

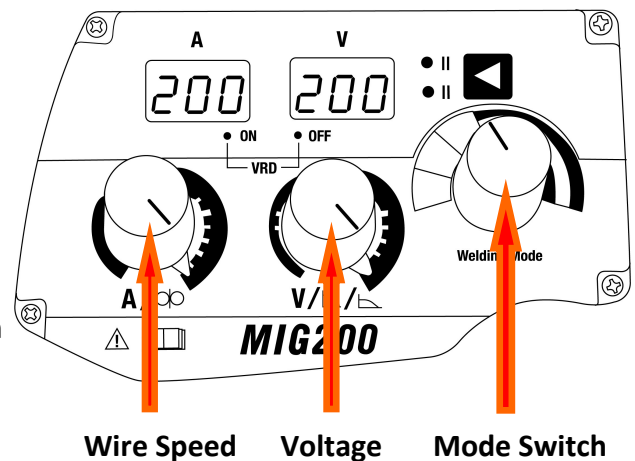

### Voltage setting

The voltage polarity in MIG/MAG welding is in the majority of cases with the positive (+). This means that the majority of the heat is in the electrode wire. Certain special wires may require the polarity to be reversed i.e. electrode wire negative (-) polarity. Always consult the manufacturer's data sheet for the best operating parameters.

The voltage is often referred to as the “heat setting”. This will be altered dependent on the material type, thickness, gas type, joint type and position of the weld. Combined with the wire speed it is the main control adjusted by the welder. The voltage setting varies depending on the type and size of electrode wire being used.

Most MIG/MAG welders are CV or Constant Voltage power sources which means the voltage does not vary much during welding. Modern inverter power sources also have control circuits to monitor conditions to ensure voltage remains constant.

The voltage determines height and width of the weld bead. If the operator has no reference to settings required the best method of set up is to use scrap material of the same thickness to obtain the correct setting. If there is too much voltage the arc will be long and uncontrollable and cause the wire to fuse to the contact tip. If the voltage is too low then there will not be enough heat to melt the wire and then stubbing occurs.

To obtain a satisfactory weld a balance needs to be made between voltage and wire speed.

Characteristics of the voltage are that the higher voltage produces a flatter and wider weld bead but care must be taken to avoid undercut. The lower the voltage the weld bead becomes narrow and higher.

# GUIDE TO MIG/MAG WELDING



Before starting any welding activity ensure that you have suitable eye protection and protective clothing. Also take the necessary steps to protect any persons within the welding area.

## Burn back control

In the event that the welder was to stop welding and all functions of the machine stopped simultaneously then the consumable filler wire would in all likelihood freeze in the weld pool. In order to avoid this happening the burn back feature is present on this machine.

This facility is usually an adjustable control within these Jasic compact MIG machines and it will allow the power and gas shield to be maintained on the consumable filler wire when it has stopped feeding thereby burning clear of the weld.

The Jasic 200CS has an inbuilt burn back facility which is automatically set by the weld parameters selected by the operator.

## Some quick reference handy tips for the MIG/MAG welding process are:

- When welding, try to use an electrode stick out (the distance between the weld and the contact tip) of around 6-8mm
- When welding thin materials try and use smaller MIG wire diameters and for thicker materials use thicker wires
- Make sure you select the correct MIG wire type for the material to be welded
- Ensure the MIG welding gun has the correct sized contact tip and type of liner
- Always ensure you have the correct size drive rolls and torch liner for the wire size selected
- Select the correct gas to achieve the correct weld characteristics and finish
- For optimum control of the weld keep the wire at the leading edge of the weld pool
- Before commencing welding, ensure a comfortable and stable position
- Try to keep the welding torch as straight as possible when welding to ensure the best feed
- Carry out daily housekeeping on the condition of the welding torch and drive rolls
- Keep any consumables clean and dry to avoid contamination such as oxidation and damp

# MIG WELDING GUIDE

## MIG Set-Up Guide

Please Note: This information is intended to act as a guide only

Material	Wire Type	Polarity	Shielding Gas (20-30 CFH Flow Rate)	Wire Dia.	0.5mm	0.6mm	0.8mm	1.0mm	1.2mm	1.6mm	3.0mm	4.5mm	6.0mm	6.0mm	8.0mm	10.0mm	
Steel	Solid Wire ER70S-6	DCEP	C25	0.6	15.5/3.2	15.5/3.6	16/4.3	16.5/5.6	17/6.4	17.5/7.8	18/9.7	18.5/10.5	-	-	-	-	
				0.8	15.5/2.3	15.5/2.4	16/2.8	16.5/3.8	17/5.1	18.5/6.4	19/7	19.5/7.9	20/8.9	20/8.9	21.5/10.5		
				1.0	15.5/1.8	15.5/2	16/2	16.5/2.8	17/3.6	18.5/4.5	19.5/5.1	19.5/7.9	20/5.7	20/5.7	21/7.6		
	Flux-Cored E71T-11	DCEN	-	0.6	16.5/3.2	16.5/3.6	17/4.3	18/5.6	18.5/6.4	19/8.6	19.5/9.9	20/10.5	20/10.5	-	-	-	-
				0.8	16.5/2.3	16.5/2.4	17/2.8	18/3.8	18.5/5.1	19.5/6.4	20.5/7	22/7.9	22/7.9	23.5/8.6	25/9.2		
				1.0	16.5/1.8	16.5/2	17/2	18/2.8	18.5/3.6	21/4.1	22/5.5	22/6	22/6	23.5/7	24.5/8		
	Stainless Steel	DCEP	Tri-Mix	0.6	-	18/4.1	18.5/4.6	19/5.6	19.5/6.4	20/8.3	20/8.3	21.5/10.2	22/9.2	22/9.2	22/9.2	22/9.2	23/10.2
				0.8	-	18/2.7	18.5/3.0	19/3.8	19.5/4.1	20/5.1	21.5/6.6	22/8.1	22/9.2	22/9.2	22/9.2	22/9.2	23/10.2
				1.0	-	18/2	18.5/2.2	18.5/2.8	19/3.1	21/4.8	21/5/6	22/6.1	22/6.1	22/6.1	22/6.1	23/7	
Aluminium	Aluminium ER4043	DCEP	Argon	0.8	-	-	-	13/7.6	14/8.1	14.5/10.2	20/8.9	21/9.3	-	-	-	-	
				1.0	-	-	-	14.5/6.1	16/7.1	17/8.6	22/9.2	22/9.2	23/9.7	23/9.7	-	-	

# MIG WELDING PROBLEMS



Before starting any welding activity ensure that you have suitable eye protection and protective clothing. Also take the necessary steps to protect any persons within the welding area.

## MIG welding defects and prevention methods

<u>Defect</u>	<u>Possible cause</u>	<u>Action</u>
Porosity (within or outside the bead)	Poor material	Check the material is clean
	Insufficient shield gas flow	Check hoses and MIG torch for blockages
	Gas flow too low/high	Check the regulator setting or that it is not frozen due to a high flow
	Leaking hoses	Check all hoses for leaks
	Faulty gas valve	Call a service engineer
	Working in open area with drafts	Put screens up around the weld area
Poor or inconsistent wire feed	Incorrect pressure on wire drive causing burn back to contact tip or bird nesting at the feed roll	Readjust the upper feed pressure  Increase the pressure to eliminate burn back to tip  Decrease pressure to eliminate bird nesting
	Damage to torch liner	Replace torch liner
	Welding wire contaminated or rusty	Replace wire
	Worn welding tip	Check and replace welding tip
No operation when the torch switch is operated	Torch switch faulty	Check the torch switch continuity and replace if faulty
	Fuse blown	Check fuses and replace if necessary
	Faulty PCB inside the equipment	Call a service engineer
Low output current	Loose or defective work clamp	Tighten/replace clamp
	Loose cable plug	Re-fix plug
	Power source faulty	Call a service engineer
No operation	No operation and mains lamp not lit	Check mains fuse and replace if required
	Faulty power source	Call a service engineer
Excessive spatter	Wire feed speed too high or welding voltage too low	Reset the parameters according to the weld to be made
Excessive penetration, the weld metal is below the surface level of the material and hangs below	Heat input too high	Reduce the amperage or use a smaller electrode and lower amperage
	Poor weld technique	Use correct welding travel speed

# MIG WELDING PROBLEMS



Before starting any welding activity ensure that you have suitable eye protection and protective clothing. Also take the necessary steps to protect any persons within the welding area.

## MIG welding defects and prevention methods

<u>Defect</u>	<u>Possible cause</u>	<u>Action</u>
Burning through – Holes within the material where no weld exists	Heat input too high	Use lower amperage or smaller electrode Use correct welding travel speed
Poor fusion – Failing of weld material to fuse either with the material to be welded or previous weld beads	Insufficient heat level Poor welding technique Work piece dirty	Increase the amperage or increase the electrode size and amperage Joint design must allow for full access to the root of the weld Alter welding technique to ensure penetration such as weaving, arc positioning or stringer bead technique Remove all contaminant from the material i.e. oil, grease, rust, moisture prior to welding
Irregular weld bead and shape	Incorrect voltage/wire feed settings. If its convex then the voltage is too low and if its concave then the voltage is too high. Insufficient or excessive heat input Wire is wandering Incorrect shielding gas	Adjust voltage and/or wire feed speed Adjust the wire feed speed dial or the voltage control Replace contact tip Check and change the shielding gas as required
Your weld is cracking	The weld beads too small Weld penetration narrow and deep Excessive voltage Weld/material cooling rate too fast	Try decreasing the travel speed Try reducing the wire feed speed current and voltage or increase MIG torch travel speed Decrease voltage control dial Slow the cooling rate by preheating part to be welded or cool slowly
The welding arc does not have a crisp sound that short arc exhibits when the wire feed speed or voltage are adjusted correctly	The MIG torch may have been connected to the wrong output voltage polarity on the front panel	Ensure that the MIG torch polarity lead is connected to the positive (+) welding terminal for solid wires and gas shielded flux cored wires



# MIG WELDING TORCH: JM-200CS

## MIG Welding Torch Air Cooled - Model: T150

Rating 180A Co2 / 150A Mixed Gases @ 60% Duty Cycle - EN60974-7 Wire Size 0.6mm to 1.0mm



### Torch Packages

T150-3    T150-4    T150-5  
 3 metre    4 metre    5 metre  
 \*Euro Fitting and Bladeswitch

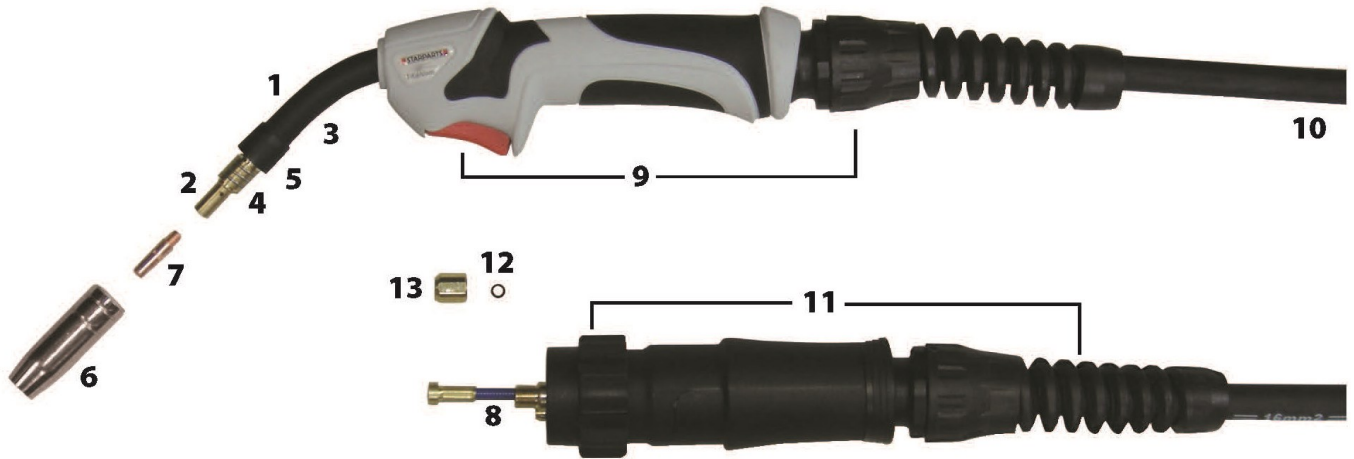

### Main Consumables

	Code	Description	Pack Qty
1	SP1554	Swan Neck Complete	1
2	SP1507	Tip Adaptor-Right Hand	5
	SP1507-LH	Tip Adaptor-Left Hand	5
3	SP1555	Insulation Sleeve	5
4	SP1557	Shroud Spring	10
5	SP1556	Insulator	5
6	SP1570	Nozzle Conical	5
	SP1571	Nozzle Cylindrical	5
	SP1572	Nozzle Tapered	5
	SP1574	Spot Welding Nozzle	5

### Contact Tips (ECU M6 x 25mm)

7	SP1506	0.6mm Steel Wire	25
	SP1508	0.8mm Steel / 0.6mm Alum Wire	25
	SP1509	0.9mm Steel Wire	25
	SP1510	1.0mm Steel / 0.8mm Alum Wire	25

### Liners (Steel Plastic Coated)

8	SP1539	0.6 - 0.9mm x 3m - P.C Blue	1
	SP1549	0.6 - 0.9mm x 4m - P.C Blue	1
	SP1559	0.6 - 0.9mm x 5m - P.C Blue	1
	SP2432	1.0 - 1.2mm x 3m - P.C Red	1
	SP2442	1.0 - 1.2mm x 4m - P.C Red	1
	SP2452	1.0 - 1.2mm x 5m - P.C Red	1

### Liners (PTFE)

	Code	Description	Pack Qty
	SP1538T	0.6 - 0.8mm x 3m - P.C Blue	1
	SP1548T	0.6 - 0.8mm x 4m - P.C Blue	1
	SP1558T	0.6 - 0.8mm x 5m - P.C Blue	1
	SP2432T	1.0 - 1.2mm x 3m - P.C Red	1
	SP2442T	1.0 - 1.2mm x 4m - P.C Red	1
	SP2452T	1.0 - 1.2mm x 5m - P.C Red	1
	SP1511	Liner Collet	5
	SP1517	Liner 'O' Ring	10

### Secondary Consumables

9	SP1625	Complete Bladeswitch Handle c/w Cable Support	1
10	SP1503	Cable Assy 3m	1
	SP1504	Cable Assy 4m	1
	SP1505	Cable Assy 5m	1
11	SP8003	Complete Euro Connection Kit c/w Support	1
12	SP1596	Gun Plug 'O' Ring	10
13	SP1597	Liner Retaining Nut	5

# GUIDE TO TIG WELDING



Before starting any welding activity ensure that you have suitable eye protection and protective clothing. Also take the necessary steps to protect any persons within the welding area.

## DC welding

Direct current welding is when the current flows in one direction only. Compared with AC welding the current once flowing will not go to zero until welding has ended.

The Jasic TIG Series polarity should generally be set up for Direct Current - Electrode Negative (DCEN) as this method of welding can be used for a wide range of materials.

The TIG welding torch is connected to the negative output of the machine and the work return cable to the positive output.

When the arc is established the current flows in the circuit and the heat distribution in the arc is around 33% in the negative side of the arc (the welding torch) and 67% in the positive side of the arc (the work piece). This balance gives deep arc penetration of the arc into the work piece and reduces heat in the electrode.

This reduced heat in the electrode allows more current to be carried by smaller electrodes compared to other polarity connections. This method of connection is often referred to as straight polarity and is the most common connection used in DC welding.

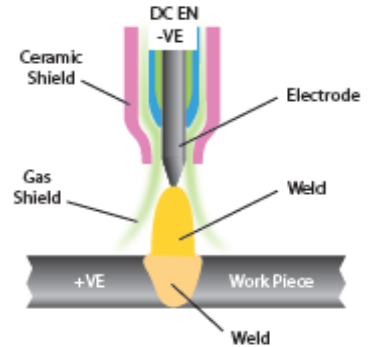

## TIG welding techniques

- Before welding (especially with mild steel) you should ensure all material being welded are clean, as particulates can weaken the weld
- The torch angle is best kept at 15 - 20° (from vertical) away from the direction of travel. This assists with visibility of the weld area and allows easier access for the filler material
- The filler metal should be fed in at a low angle to help avoid touching the tungsten electrode and contaminating it
- The TIG welding arc melts the base material and the molten puddle melts the filler rod, it is important you resist the urge to melt the filler material directly into the welding arc
- For thinner sheet materials, a filler material may not be needed
- Prepare the tungsten correctly, using a diamond grinding wheel will give you the best results for a sharp point see page 36
- For welding stainless steel, be careful of applying too much heat. If the colour is dark grey and looks dirty and heavily oxidized then too much heat has been applied, this could also cause the material to warp. Reducing the amperage and increase travel speed may correct this problem, you could also consider using a smaller diameter filler material, as that will require less energy to melt

## TIG welding amperage guide

Base Metal Thickness	Mild Steel DC Current	Stainless Steel DC Current	Tungsten Electrode Diameter	Filler Wire Diameter (If required)	Argon Gas Flow Rate (Litres/Min)	Joint Types
1.0mm	40-50	25-35	1.0mm	1.6mm	5-7	Butt/Corner/Fillet/Lap
1.2mm	50-60	35-50	1.0mm	1.6mm	5-7	Butt/Corner/Fillet/Lap
1.6mm	70-90	50-70	1.6mm	1.6mm	6-8	Butt/Corner/Fillet/Lap
3.2mm	90-115	90-110	1.6mm	2.4mm	7-9	Butt/Corner/Fillet/Lap
4.8mm	140-165	125-150	2.4mm	3.2mm	10-12	Butt/Corner/Fillet/Lap
6.4mm	170-200	160-180	3.2mm	4.0mm	10-12	Butt/Corner/Fillet/Lap

# GUIDE TO TIG WELDING



Before starting any welding activity ensure that you have suitable eye protection and protective clothing. Also take the necessary steps to protect any persons within the welding area.

## TIG torch body and components

The torch body holds the various welding consumables in place as shown and is covered by a either a rigid phenolic or rubberised covering.

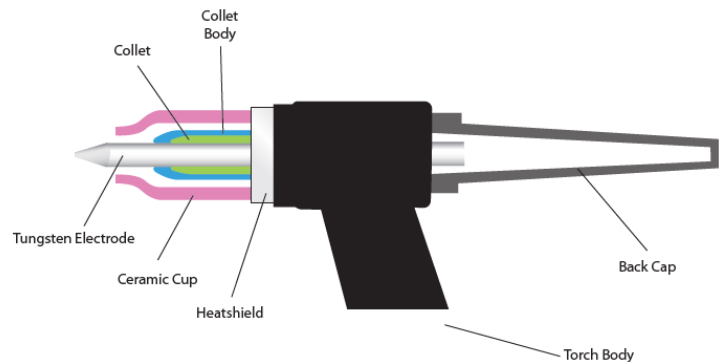

### Collet body

 The collet body screws into the torch body. It is replaceable and is changed to accommodate the different size tungsten's and their respective collets.

### Collets

 The welding electrode (tungsten) is held in the torch by the collet. The collet is usually made of copper or a copper alloy. The collet's grip on the electrode is secured when the torch back cap is tightened in place. Good electrical contact between the collet and tungsten electrode is essential for good welding current transfer.

### Gas lens body

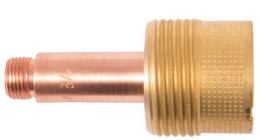
 A gas lens is a device that can be used in place of the normal collet body. It screws into the torch body and is used to reduce turbulence in the flow of shield gas and produce a stiff column of undisturbed flow of shielding gas. A gas lens will allow the welder to move the nozzle further away from the joint allowing increased visibility of the arc. A much larger diameter nozzle can be used which will produce a large blanket of shielding gas. This can be very useful in welding material like titanium. The gas lens will also enable the welder to reach joints with limited access such as inside corners.

### Ceramic cups

 Gas cups are made of various types of heat resistant materials in different shapes, diameters and lengths. The cups are either screwed onto the collet body or gas lens body or in some cases pushed in place. Cups can be made of ceramic, metal, metal-jacketed ceramic, glass or other materials. The ceramic type is quite easily broken so take care when putting the torch down.

Gas cups must be large enough to provide adequate shielding gas coverage to the weld pool and surrounding area. A cup of a given size will allow only a given amount of gas to flow before the gas flow becomes disturbed due to the speed of flow. Should this condition exist the size of cup should be increased to allow the flow speed to reduce and once again establish an effective regular shield.

### Back cap

The back cap screws into the rear on the torch head and applies pressure to the back end of the collet which in turn forces up against the collet body, the resulting pressure holds the tungsten in place to ensure it does not move during the welding process. Back caps are made from a rigid phenolic material and generally come in 3 sizes, short, medium and long.

# GUIDE TO TIG WELDING



Before starting any welding activity ensure that you have suitable eye protection and protective clothing. Also take the necessary steps to protect any persons within the welding area.

## TIG welding electrodes

TIG welding electrodes are a 'non consumable' as it is not melted into the weld pool and great care should be taken not to let the electrode contact the welding pool to avoid weld contamination. This would be referred to as tungsten inclusion and may result in weld failure.

Electrodes will often contain small quantities of metallic oxides which can offer the following benefits:

- Assist in arc starting
- Improve current carrying capacity of the electrode
- Reduce the risk of weld contamination
- Increase electrode life
- Increase arc stability

Oxides used are primarily zirconium, thorium, lanthanum or cerium. These are added usually 1% - 4%.



Tungsten Electrode Colour Chart - DC

Welding Mode	Tungsten Type	Colour
DC or AC/DC	Ceriated 2%	Grey
DC or AC/DC	Lanthanated 1%	Black
DC or AC/DC	Lanthanated 1.5%	Gold
DC or AC/DC	Lanthanated 2%	Blue
DC	Thoriated 1%	Yellow
DC	Thoriated 2%	Red

Tungsten Electrode Current Ranges

Tungsten Electrode Size	DC Current Amp
1.0mm	30 - 60
1.6mm	60 - 115
2.4mm	100 - 165
3.2mm	135 - 200
4.0mm	190 - 280
4.8mm	250 - 340

## Tungsten electrode preparation - DC

When welding at low current the electrode can be ground to a point. At higher current a small flat on the end of the electrode is preferable as this helps with arc stability.

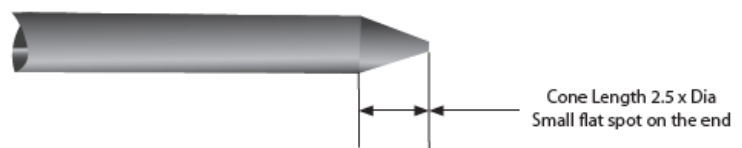

On inverter controlled AC & DC machines use tungsten electrode with cone length around 2.5 times the tungsten diameter

## Electrode grinding

It is important when grinding the electrode to take all necessary precautions such as wearing eye protection and ensuring adequate protection against breathing in any grinding dust.

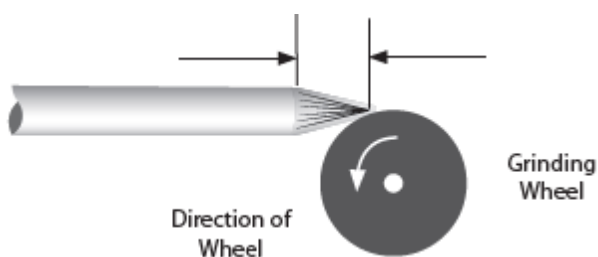

Tungsten electrodes should always be ground lengthwise (as shown) and not in a radial operation. Electrodes ground in a radial operation tend to contribute to arc wander due to the arc transfer from the grinding pattern. Always use a grinder solely for grinding electrodes to avoid contamination.

# GUIDE TO TIG WELDING



Before starting any welding activity ensure that you have suitable eye protection and protective clothing. Also take the necessary steps to protect any persons within the welding area.

## TIG welding consumables

The consumables of the TIG welding process are filler wires and shield gas.

### Filler wires

Filler wires come in many different material types and usually as cut lengths, unless some automated feeding is required where it will be in reel form.

Filler wire is generally fed in by hand.

Always consult the manufacturer's data and welding requirements.

Filler Wire Diameter	DC Current Range (Amps)
1.0mm	20-90
2.4mm	65-115
3.2mm	100-165
4.8mm	200-350

Filler Wire Selection Guide

### Gases

Shielding gas is required when welding to keep the weld pool free of oxygen. Whether you are welding mild steel or stainless steel the most commonly used shielding gas used in TIG welding is argon, for more specialised applications an argon helium mix or pure helium maybe used.

### TIG welding arc starting - Lift TIG (lift arc)

Not to be confused with scratch start, this arc starting method allows the tungsten to be in direct contact with the work piece first but with minimal current so as not to leave a tungsten deposit when the tungsten is lifted and an arc is established.

With lift TIG start the open circuit voltage (OCV) of the welder folds back to a very low voltage output when the unit senses it has made continuity with the work piece. Once the torch is lifted the unit increases output as the tungsten leaves the surface. This creates little contamination and preserves the point on the tungsten although this is still not a 100% clean process. The tungsten can still get contaminated but lift TIG is still a much better option than scratch starting for mild and stainless steel although these methods of arc starting are not a good option when welding aluminium.

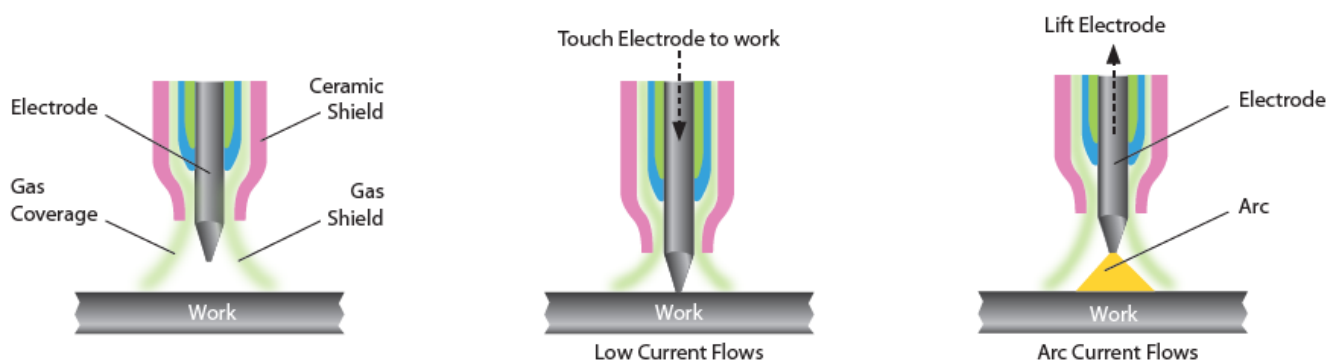

# TIG WELDING TORCH: EURO TYPE FOR JM-200CS

## TIG Welding Torch Air Cooled - Model TIG54

Rating 350A DC, 260A AC @ 100% Duty Cycle EN60974-7 • 0.5mm to 4.0mm Electrodes

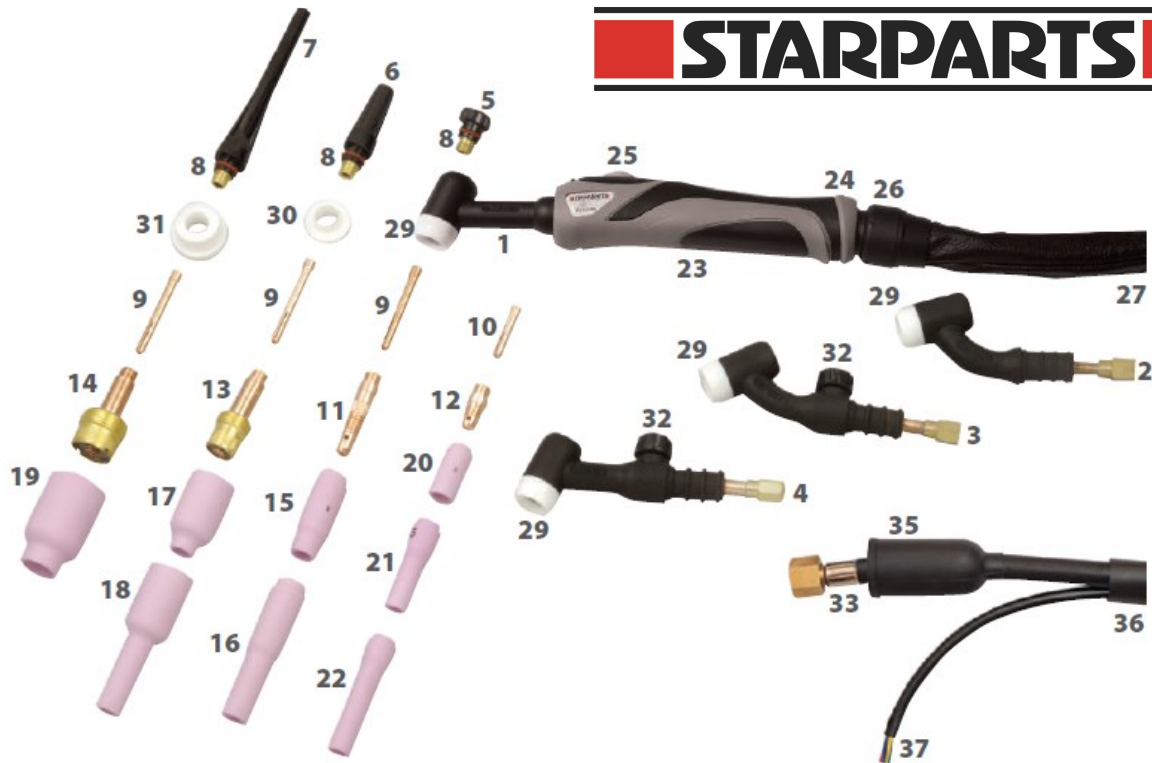

### Main Consumables

No	Code	Description
1	WP17	Rigid Torch Body
2	WP17F	Flexible Torch Body
3	WP17FV	Flexible Torch Body c/w Valve
4	WP17V	Torch Body c/w Argon Valve
5	57Y04	Short Back Cap
6	300M	Medium Back Cap
7	57Y02	Long Back Cap
8	98W18	Back Cap 'O' Ring

### Collets

9	10N21	Standard .020" (0.5mm)
	10N22	Standard .040" (1.0mm)
	10N23	Standard 1/16" (1.6mm)
	10N26	Standard 5/64" (2.0mm)
	10N24	Standard 3/32" (2.4mm)
	10N25	Standard 1/8" (3.2mm)
10	10N21S	Stubby .020" (0.5mm)
	10N22S	Stubby .040" (1.0mm)
	10N23S	Stubby 1/16" (1.6mm)
	10N24S	Stubby 3/32" (2.4mm)
	10N25S	Stubby 1/8" (3.2mm)

### Collet Bodies

11	10N29	Standard .020" (0.5mm)
	10N30	Standard .040" (1.0mm)
	10N31	Standard 1/16" (1.6mm)
	10N31M	Standard 5/64" (2.0mm)
	10N32	Standard 3/32" (2.4mm)
	10N28	Standard 1/8" (3.2mm)
12	17CB20	Stubby .020"- 1/8" (0.5 - 3.2mm)

### Gas Lens Bodies

13	45V29	Standard .020" (0.5mm)
	45V24	Standard .040" (1.0mm)
	45V25	Standard 1/16" (1.6mm)
	45V25M	Standard 5/64" (2.0mm)
	45V26	Standard 3/32" (2.4mm)
	45V27	Standard 1/8" (3.2mm)

### Gas Lens Bodies

14	45V0204	Large Dia .020"-.040" (0.5 - 1.0mm)
	45V116	Large Dia 1/16" (1.6mm)
	45V64	Large Dia 3/32" (2.4mm)
	995795	Large Dia 1/8" (3.2mm)

### Ceramic Cups

15	10N50	Standard Cup 1/4" Bore
	10N49	Standard Cup 5/16" Bore
	10N48	Standard Cup 3/8" Bore
	10N47	Standard Cup 7/16" Bore
	10N46	Standard Cup 1/2" Bore
	10N45	Standard Cup 5/8" Bore
	10N44	Standard Cup 3/4" Bore
16	10N50L	Long Cup 1/4" Bore
	10N49L	Long Cup 5/16" Bore
	10N48L	Long Cup 3/8" Bore
	10N47L	Long Cup 7/16" Bore

### Gas Lens Cups

17	54N18	Standard Cup 1/4" Bore
	54N17	Standard Cup 5/16" Bore
	54N16	Standard Cup 3/8" Bore
	54N15	Standard Cup 7/16" Bore
	54N14	Standard Cup 1/2" Bore
	54N19	Standard Cup 11/16" Bore
18	54N17L	Long Cup 5/16" Bore
	54N16L	Long Cup 3/8" Bore
	54N15L	Long Cup 7/16" Bore
	54N14L	Long Cup 1/2" Bore
19	57N75	Large Dia Cup 3/8" Bore
	57N74	Large Dia Cup 1/2" Bore
	53N88	Large Dia Cup 5/8" Bore
	53N87	Large Dia Cup 3/4" Bore

### Ceramic Cups for use with item 12

20	13N08	Standard Cup 1/4" Bore
	13N09	Standard Cup 5/16" Bore
	13N10	Standard Cup 3/8" Bore
	13N11	Standard Cup 7/16" Bore
	13N12	Standard Cup 1/2" Bore
	13N13	Standard Cup 5/8" Bore
21	796F70	Long Cup 3/16" Bore
	796F71	Long Cup 1/4" Bore
	796F72	Long Cup 5/16" Bore
	796F73	Long Cup 3/8" Bore
22	796F74	X - Long Cup 3/16" Bore
	796F75	X - Long Cup 1/4" Bore
	796F76	X - Long Cup 5/16" Bore
	796F77	X - Long Cup 3/8" Bore

### Secondary Consumables

23	SP9110	LH & RH Handle Shell
24	SP9111	Handle Screw
25	SP9120	Single Button Switch
	SP9121	2 Button Switch
	SP9122	5K Potentiometer Switch
	SP9123	10K Potentiometer Switch
	SP9128	47K Potentiometer Switch
	SP9129	4 Button Switch
26	SP9113	Handle Ball Joint
27	SP9116	Leather Cover 800mm
28	SP9118	Cable Cover Joint (not illustrated)
29	18CG	Standard Heat Shield
30	54N01	Gas Lens Heat Shield
31	54N63	Large Gas Lens Insulator
32	VS-2	Valve Stem WP17V & WP17FV
33	57Y01	Mono Power Cable 12.5ft - 3/8"
	57Y03	Mono Power Cable 25ft - 3/8" Bsp
34	57Y01-2D	2 Piece Power Cable Assy 12.5ft
	57Y03-2D	2 Piece Power Cable Assy 25ft
35	0315071	Insulation Boot
36	SP9002	Neoprene Protective Cover 1m
37	SP9126	4m Switch Cable
	SP9127	8m Switch Cable
--	JSP-01	2 Pin Control Plug (TIG Torch)
--	10004655	5 Pin Control Plug (Remote)

PLEASE NOTE:

Check torch supplied with your package to ensure it matches the above details

# TIG WELDING PROBLEMS



Before starting any welding activity ensure that you have suitable eye protection and protective clothing. Also take the necessary steps to protect any persons within the welding area.

## TIG welding defects and prevention methods

<u>Defect</u>	<u>Possible cause</u>	<u>Action</u>
Excessive tungsten use	Set up for DCEP	Change to DCEN
	Insufficient shield gas flow	Check for gas restriction and correct flow rates. Check for drafts in the weld area.
	Electrode size too small	Select correct size
	Electrode contamination during cooling time	Extend post flow gas time
Porosity/weld contamination	Loose torch or hose fitting	Check and tighten all fittings
	Inadequate shield gas flow	Adjust flow rate - normally 8-12L/m
	Incorrect shield gas	Use correct shield gas
	Gas hose damaged	Check and repair any damaged hoses
	Base material contaminated	Clean material properly
	Incorrect filler material	Check correct filler wire for grade of use
No operation when torch switch is operated	Torch switch or cable faulty	Check the torch switch continuity and repair or replace as required
	ON/OFF switch turned off	Check position of ON/OFF switch
	Mains fuses blown	Check fuses and replace as required
	Fault inside the machine	Call for a repair technician
Low output current	Loose or defective work clamp	Tighten/replace clamp
	Loose cable plug	Check and tighten all plugs
	Power source faulty	Call a repair technician
Will not strike an arc	Weld/power cable open circuit	Check all cables and connections for continuity, especially the torch cables
	No shield gas flowing	Check cylinder contents, regulator and valves, also check the power source
Unstable arc when welding in DC	Tungsten contaminated	Break off contaminated end and regrind the tungsten
	Arc length incorrect	Arc length should be between 3-6mm
	Material contaminated	Clean all base and filler material
	Electrode connected to the wrong polarity	Reconnect to correct polarity
Arc is difficult to start	Incorrect tungsten type	Check and fit correct tungsten
	Incorrect shield gas	Use argon shield gas

# TIG WELDING PROBLEMS



Before starting any welding activity ensure that you have suitable eye protection and protective clothing. Also take the necessary steps to protect any persons within the welding area.

## TIG welding defects and prevention methods

<u>Defect</u>	<u>Possible cause</u>	<u>Action</u>
Excessive bead build up, poor penetration or poor fusion at the edges of the weld	Weld current too low	Increase the welding amperage Poor material prep
Weld bead flat and too wide or undercut at the weld edge or burning through	Weld current too high	Decrease the welding amperage
Weld bead too small or insufficient penetration	Welding travel speed too fast	Reduce your welding travel speed
Weld bead too wide or excessive bead build up	Welding travel speed too slow	Increase your welding travel speed
Uneven leg length in fillet joint	Wrong placement of filler rod	Re-position filler rod
Tungsten melts or oxidises when welding arc is made	TIG torch lead connected to + Little or no gas flow to weld pool  Gas cylinder or hoses contain impurities The tungsten is too small for the weld current TIG/MMA selector set to MMA	Connect to - polarity Check gas apparatus as well as torch and hoses for breaks or restrictions Change gas cylinder and blow out torch and gas hoses Increase the size of the tungsten  Ensure you have the power source set to TIG function



## MAINTENANCE



The following operation requires sufficient professional knowledge on electric aspects and comprehensive safety knowledge. Make sure the input cable of the machine is disconnected from the electricity supply and wait for 5 minutes before removing the machine covers.

In order to guarantee that the arc welding machine works efficiently and in safety, it must be maintained regularly. Operators should understand the maintenance methods and means of arc welding machine operation. This guide should enable customers to carry out simple examination and safeguarding by oneself, try to reduce the fault rate and repair times of the arc welding machine, so as to lengthen service life of the MIG welding machine.

### Period

### Maintenance item

<b>Daily examination</b>	<ul style="list-style-type: none"> <li>• Check the condition of the machine, mains cables, welding cables and connections</li> <li>• Check for any warnings LEDs and machine operation</li> </ul>
<b>Monthly examination</b>	<ul style="list-style-type: none"> <li>• Disconnect from the mains supply and wait for at least 5 minutes before removing the cover</li> <li>• Check internal connections and tighten if required</li> <li>• Clean the inside of the machine with a soft brush and vacuum cleaner</li> <li>• Take care not to remove any cables or cause damage to components</li> <li>• Ensure that ventilation grills are clear</li> <li>• Carefully replace the covers and test the unit</li> </ul> <p><b>This work should be carried out by a suitably qualified competent person</b></p>
<b>Yearly examination</b>	<ul style="list-style-type: none"> <li>• Carry out an annual service to include safety check in accordance with the manufacturers standard (EN 60974-1)</li> </ul> <p><b>This work should be carried out by a suitably qualified competent person</b></p>

⇒ **Ensure the power is disconnected before working on the machine.**

⇒ **Always wait 5 minutes after power switch off before opening the case.**

## SERVICE SCHEDULE RECORD

Date	Type of service and work carried out	Serviced by	Due date for next check

## TROUBLESHOOTING



The following operation requires sufficient professional knowledge on electric aspects and comprehensive safety knowledge. Make sure the input cable of the machine is disconnected from the electricity supply and wait for 5 minutes before removing the machine covers.

Before arc welding machines are dispatched from the factory, they have already been checked thoroughly. The machine should not be tampered with or altered. Maintenance must be carried out carefully. If any wire becomes loose or is misplaced, it maybe potentially dangerous to the user!

Only professional maintenance personnel should repair the machine!

Ensure the power is disconnected before working on the machine. Always wait 5 minutes after power switch off before removing the panels.

Description of fault	Possible cause
The digital display is OFF and the fan is not functioning	The primary supply voltage has not been switched ON or input fuse has blown
	The welding power source input switch is switched OFF
	Loose connections internally
The digital display is ON but the fan is not running	The machine fan blades may be jammed The machine fan may not be functional Check the wiring and the supply voltage to the fan
Wire feed motor does not rotate when the MIG torch trigger switch is depressed	Check wire feed speed, to ensure its not set to zero
	Check supply to wire feed motor
	Possible motor PCB fault
Output current reduces when welding	Poor work lead connection to the work piece
TIG electrode melts when arc is struck	TIG torch is connected to the (+) VE terminal
No gas flow when the MIG torch trigger switch is depressed	Empty gas cylinder
	Gas regulator is turned off
	Gas hose is blocked or cut
	Torch trigger switch lead is disconnected or switch/lead is faulty
Difficult to ignite the arc	The welding voltage is too low or the wire feed speed is set too high
The electrode holder becomes very hot	The rated current of the electrode holder is smaller than its actual working current, replace it with a higher rated current capacity
Excessive spatter in MMA welding	The output polarity connection is incorrect, exchange the polarity
Other malfunction	Contact your supplier
Overheat error code lights up	Let the machine cool, it will automatically start again
	Insufficient cooling air
	Cooling fan is not running
Wire continues to feed through when the MIG torch switch is released	The trigger mode switch is set to 4T rather than 2T Faulty MIG torch switch
Error code 'Err 0' on display	Over current protection has engaged - power machine off and then back on
Error code 'Err 1' on display	Mains input voltage too low - check mains supply
Error code 'Err 2' on display	Overheat protection - Allow machine to cool down
Error code 'Err 3' on display	Overload protection - power machine off and then back on

## WEEE disposal

The equipment is manufactured with materials which do not contain any toxic or poisonous materials dangerous to the operator.

When the equipment is scrapped, it should be dismantled separating components according to the type of materials.

Do not dispose of the equipment with normal waste. The European Directive 2002/96/EC and United Kingdom's Directive The Waste Electrical and Electronic Equipment (WEEE) regulations 2013 states that electrical equipment that has reached its end of life must be collected separately and returned to an environmentally compatible recycling facility.

Jasic has a relevant recycling system which is compliant and registered in the UK with the environment agency. Our registration reference is WEEMM3813AA.

In order to comply with WEEE regulations outside the UK you should contact your supplier.

## RoHS Compliance Declaration

We herewith confirm, that the above mentioned product does not contain any of the restricted substances as listed in EU Directive 2011/65/EU and the UK directive ROHS Regulations 2012 in concentrations above the limits as specified therein.

## UKCA Declaration of Conformity

The manufacturer, or its legal representative Wilkinson Star Limited, declares that the equipment described below is designed and produced according to following UK legislation:

- Electrical equipment safety 2016
- Electromagnetic compatibility (EMC) regulations 2016
- The restrictions of the use of certain hazardous substances in electrical and electronic equipment regulations 2012

And inspected according to following designated standards:

- EN 60 974-1:2018+A1:2019
- EN 60 974-10:2014+A1:2015

Any alteration or change to these machines by any unauthorized person makes this declaration invalid.

**Model:**

**JM-200CS**

**Authorised Representative:**

Wilkinson Star Limited  
Shield Drive  
Wardley Industrial Estate  
Worsley  
Manchester  
M28 2WD

### **Disclaimer:**

Please note that this confirmation is given to the best of our present knowledge and belief. Nothing herein represents and/or may be interpreted as warranty within the meaning of the applicable warranty law.

# EC Declaration of Conformity

## EC DECLARATION OF CONFORMITY

The manufacturer, or its legal representative **Wilkinson Star Limited**, declares that the equipment described below is designed and produced according to following EU Directives:

- Low Voltage Directive (LVD), No.: 2014/35/EU
- Electromagnetic compatibility (EMC) Directive, No.: 2014/30/EU

And inspected according to following

EU - Norms:

- EN 60 974-1:2012
- EN 60 974-10:2014+A1

Any alteration or change to these machines by any unauthorized person makes this Declaration invalid.

### Wilkinson Star model

JM-160C  
JM-200C  
JM-200CS

### Jasic Model

MIG 160 (N219)  
MIG 200 (N220)  
MIG 200 (N229)

### Authorised Representative

Wilkinson Star Limited  
Shield Drive, Wardley Industrial Estate,  
Worsley, Manchester M28 2WD  
Tel 0161 793 8127

### Manufacturer

Shenzhen Jasic Technology Co LTD  
No3 Qinglan, 1st Road  
Pingshan District  
Shenzhen, China

Signature

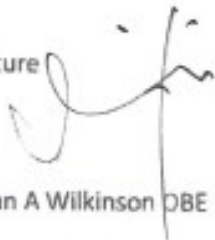

Dr John A Wilkinson DBE

Position Chairman

Signature



Shenzhen Jasic Technology Co LTD

Position

Date



Date



## STATEMENT OF WARRANTY

All new JASIC welders, plasma cutters and multi-process units sold through our partner Wilkinson Star Limited within the United Kingdom and Ireland shall be warranted to the original owner, non transferable, against failure due to defective materials or production. The warranty period is 5 years following the date of purchase. We recommend you register your product within 28 days of purchase. The original invoice is documentation for the standard warranty period. The warranty period is based on a single shift pattern.

Defective units shall be repaired or replaced by the company at our workshop. The company may opt to refund the purchase price (less any costs and depreciation due to use and wear). The company reserves the right to alter the warranty conditions at any time with effect for the future.

A prerequisite for the full warranty is that products are operated in accordance with the operating instructions supplied, observing the relevant installation and any legal requirements recommendations and guidelines and carrying out the maintenance instructions shown in the operator manual. This should be carried out by a suitably qualified competent person.

In the unlikely event of a problem, this should be reported to Jasic technical support team to review the claim.

The customer has no claim to loan or replacement products whilst repairs are being performed.

The following falls outside the scope of the warranty:

- Defects due to natural wear and tear
- Failure to observe the operating and maintenance instructions
- Connection to an incorrect or faulty mains supply
- Overloading during use
- Any modifications that are made to the product without the prior written consent
- Software errors due incorrect operation
- Any repairs that are carried out using non-approved spare parts
- Any transport or storage damage
- Direct or indirect damage as well as any loss of earnings are not covered under the warranty
- External damage such as fire or damage due to natural causes e.g. flooding

**NOTE:** Under the terms of the warranty, welding torches, their consumable parts, wire feed unit drive rolls and guide tubes, work return cables and clamps, electrode holders, connection and extension cables, mains and control leads, plugs, wheels, coolant etc. are covered with a 3 month warranty.

Jasic shall in no event be responsible for any third party expenses or expenses/costs or any indirect or consequential expenses/costs.

Jasic will submit an invoice for any repair work performed outside the scope of the warranty. A quotation for any non warranty will be raised prior to any repairs being carried out.

The decision about repair or replacement of the defective part(s) is made by Jasic. The replaced part(s) remain(s) Jasic property.

Warranty extends only to the machine, its accessories and parts contained inside. No other warranty is expressed or implied. No warranty is expressed or implied in regards to the fitness of the product for any particular application or use.

For further information on Jasic product warranty terms and product warranty registration please visit:

**[www.jasic-warranty.co.uk/terms](http://www.jasic-warranty.co.uk/terms)**

**[www.jasic-warranty.co.uk](http://www.jasic-warranty.co.uk)**

# SCHEMATIC

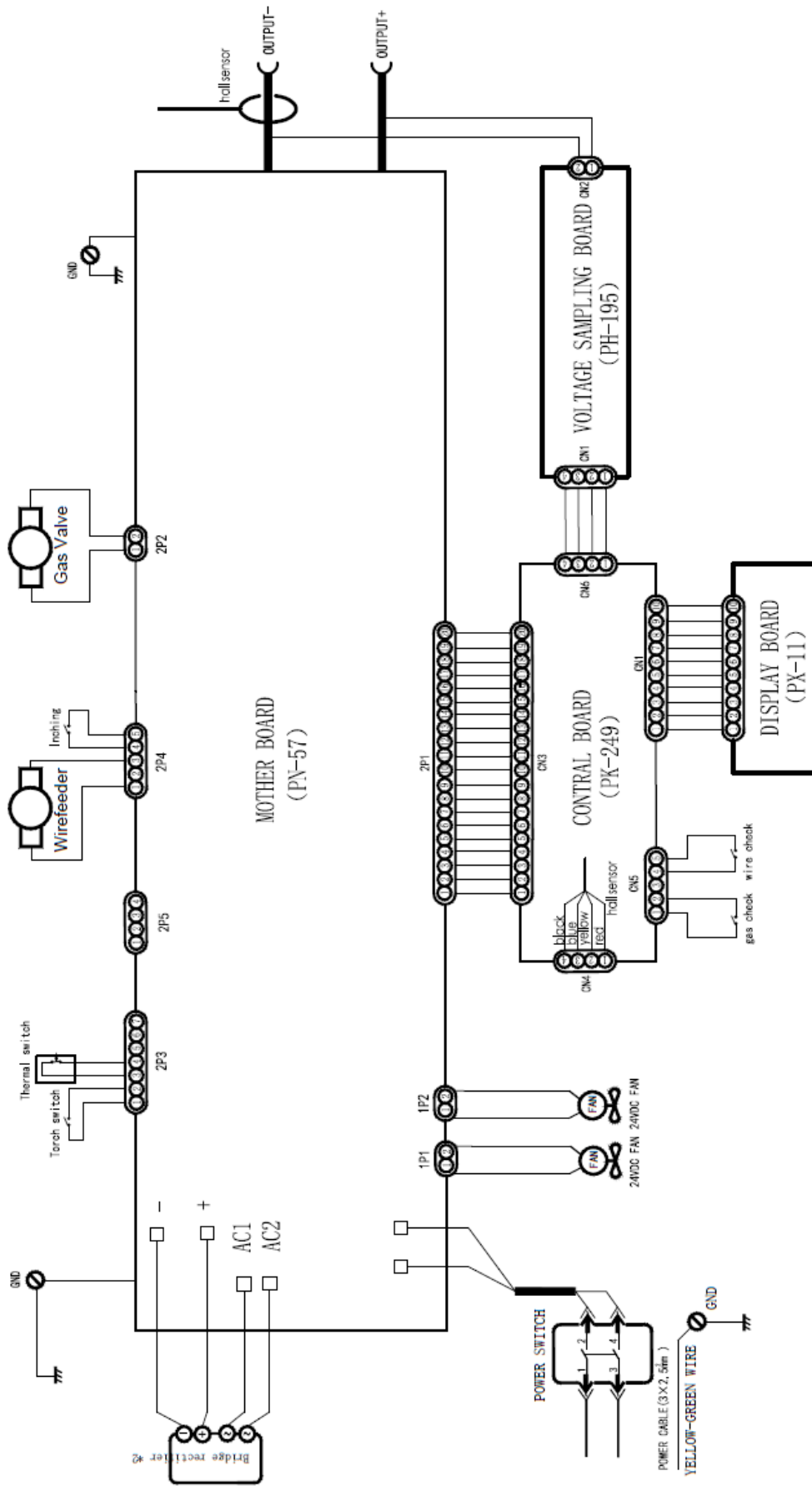

## OPTIONS AND ACCESSORIES

Part Number	Description
T150-3	Titanium 150 MIG Torch 3mtr Euro
T150-4	Titanium 150 MIG Torch 4mtr Euro
T150-5	Titanium 150 MIG Torch 5mtr Euro
WCS25-3WEL	Welding Cable Set (MMA) 3m
WC-2-03LD	Electrode Holder and Lead 3m
EC-2-03LD	Work Return Lead and Clamp 3m
WP26-12JE	WP26 Euro Style TIG Torch 4m
WP26-25JE	WP26 Euro Style TIG Torch 8m
CP3550	Cable Plug 35-50mm
JIT-01	Trolley
JH-HDX	Jasic HD True Colour Auto Darkening Welding Helmet
SSARG2G	Single Stage 2 Gauge Argon Regulator
WTLHK2	2mtr Gas Hose and Quick Gas Connector
10048354	"V" Groove 0.6mm/0.8mm
10048356	"V" Groove 0.8mm/1.0mm
10048347	"V" Groove 1.0mm/1.2mm
B6200ZZ	Flat Pressure Roll
10048338	Knurled 0.8mm/1.0mm (FCW)
10048352	"U" Groove 0.6mm/0.8mm
10048349	"U" Groove 0.8mm/1.0mm
10048353	"U" Groove 1.0mm/1.2mm



Jasic Auto Darkening HD  
Welding Helmet  
with True Colour Technology  
JH-HDX









**Wilkinson Star Limited**

Shield Drive

Wardley Industrial Estate

Worsley

Manchester

UK

M28 2WD

**+44 (0)161 793 8127**



[www.jasic.co.uk](http://www.jasic.co.uk)  
November 2022 Issue 7