

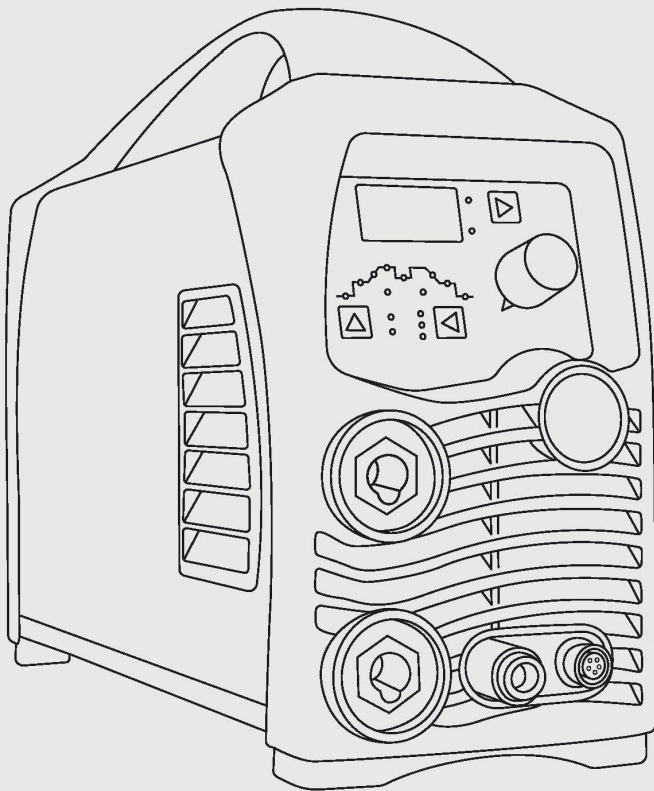

TIG Series

TIG 200 Pulse PFC (JT-200P-PFC)



Operator Manual



Intertek

CE

UK
CA



Your new product

Thank you for selecting this Jasic product.

This product manual has been designed to ensure that you get the most from your new product. Please ensure that you are fully conversant with the information provided paying particular attention to the safety precautions. The information will help protect yourself and others against the potential hazards that you may come across.

Please ensure that you carry out daily and periodic maintenance checks to ensure years of reliable and trouble free operation.

Please call your Jasic distributor in the unlikely event of a problem occurring.
Please record below the details from your product as these will be required for warranty purposes and to ensure you get the correct information should you require assistance or spare parts.

Date purchased _____

From where _____

Serial number _____

(The serial number is normally located on the top or underside of the machine and will begin with AA).

For further information on your Jasic product warranty registration please visit:

www.jasic-warranty.co.uk

Disclaimer

Whilst every effort has been made to ensure that the information contained within this manual is complete and accurate, no liability can be accepted for any errors or omissions.

Please note:

Products are subject to continual development and may be subject to change without notice.

Regularly check our product pages at www.Jasic.co.uk for revision updated operating manuals.

No part of this manual may be copied or reproduced by any means without the written permission of Wilkinson Star Limited.

CONTENTS

Index	Page
Your New Product	2
Index	3
Safety Instruction	4
General electrical safety	4
General operating safety	4
PPE	5
Welding processes lens shade selector guide	5
Fume and welding gases	6
Fire risks	6
The working environment	7
Protection from moving parts	7
Magnetic fields	7
Compressed gas cylinders and regulators	7
RF declaration	8
LF declaration	8
Materials and their disposal	8
Product Overview	9
Technical Specifications	10
Description of Controls	11
Installation	15
Operation MMA	17
Operation TIG	19
Remote Control Socket	24
Guide to MMA Welding	25
MMA Welding Problems	29
Guide to TIG Welding	30
TIG Welding Torch	36
TIG Welding Problems	37
Maintenance	39
Service Schedule Record	39
Troubleshooting	40
WEEE Disposal	41
RoHS Compliance Declaration	41
UKCA Declaration of Conformity	41
EC Declaration of Conformity	42
Statement of Warranty	43
Options and Accessories	44
Schematic	45
Notes	46
Jasic Contact Details	48

SAFETY INSTRUCTIONS

These general safety norms cover both arc welding machines and plasma cutting machines unless otherwise noted.

It is important that users of this equipment protect themselves and others from harm or even death. The equipment must only be used for the purpose it was designed for. Using it in any other way could result in damage or injury and in breach of the safety rules.

Only suitably trained and competent persons should use the equipment.

Pacemaker wearers should consult their doctor prior to using this equipment.

PPE and workplace safety equipment must be compatible for the application of the work involved.

Always carry out a risk assessment before undertaking any welding or cutting activity

General electrical safety



The equipment should be installed by a qualified person and in accordance with current local electrical safety standards. It is the users responsibility to ensure that the equipment is connected to a suitable power supply. Consult with your utility supplier if required.

Do not use the equipment with the covers removed.

Do not touch live electrical parts or parts which are electrically charged.

Turn off all equipment when not in use.

In the case of abnormal behaviour of the equipment, the equipment should be checked by a suitably qualified service engineer.

If earth bonding of the work piece is required, bond it directly with a separate cable with a current carrying capacity capable of carrying the maximum capacity of the machine current.

Cables (both primary supply and welding) should be regularly checked for damage and overheating.

Never use worn, damaged, under sized or poorly jointed cables.

Insulate yourself from work and earth using dry insulating mats or covers big enough to prevent any physical contact.

Never touch the electrode if you are in contact with the work piece return.

Do not wrap cables over your body.

Ensure that you take additional safety precautions when you are welding in electrically hazardous conditions such as damp environments, wearing wet clothing and metal structures.

Try to avoid welding in cramped or restricted positions.

Ensure that the equipment is well maintained. Repair or replace damaged or defective parts immediately.

Carry out any regular maintenance in accordance with the manufacturers instructions.

The EMC classification of this product is class A in accordance with electromagnetic compatibility standards CISPR 11 and IEC 60974-10 and therefore the product is designed to be used in industrial environments only.

WARNING: This class A equipment is not intended for use in residential locations where the electrical power is provided by a public low-voltage supply system. In those locations it may be difficult to ensure the electromagnetic compatibility due to conducted and radiated disturbances.

General operating safety

Never carry the equipment or suspend it by the carrying strap or handles during welding.

Never pull or lift the machine by the welding torch or other cables. Always use the correct lift points or handles. Always use the transport under gear as recommended by the manufacturer.

Never lift a machine with the gas cylinder mounted on it.

If the operating environment is classified as dangerous, only use S-marked welding equipment with a safe idle voltage level. Such environments may be for example: humid, hot or restricted accessibility spaces.

SAFETY INSTRUCTIONS

Use of Personal Protective Equipment (PPE)

Welding arc rays from all welding processes produce intense, visible and invisible (ultraviolet and infrared) rays that can burn eyes and skin.

- Wear an approved welding helmet fitted with an appropriate shade of filter lens to protect your face and eyes when welding or watching.
- Wear approved safety glasses with side shields under your helmet.
- Never use broken or faulty welding helmets.
- Always ensure there are adequate protective screens or barriers to protect others from flash, glare and sparks from the welding area.
- Ensure that there are adequate warnings that welding or cutting is taking place.
- Wear suitable protective flame resistant clothing, gloves and footwear.
- Check and be sure the area is safe and clear of inflammable material before carrying out any welding.

Some welding and cutting operations may produce noise. Wear safety ear protection to protect your hearing if the ambient noise level exceeds the local allowable limit (e.g: 85 dB).



Welding and Cutting Lens Shade Selector Guide

CURRENT	MMA ELECTRODES	MIG LIGHT ALLOYS	MIG HEAVY METALS	MAG	TIG ON ALL METALS	PLASMA CUTTING	PLASMA WELDING	GOUGING ARC/AIR
10	8							
15								
20	9	10	10	10	10			
30								
40	10					11	11	10
60								
80	11	11		11	11			
100								
125	12		11	12	12		12	
150								
175	13	13					13	11
200								
225	14	14	13	13	13	12		12
250								
275	15	15					14	13
300								
350	16	16			14	13	14	14
400								
450	17	17	14	15				15
500								

SAFETY INSTRUCTIONS

Safety against fumes and welding gases



Warning
Fumes and
Gases

The HSE have identified welders as being an 'at risk' group for occupational diseases arising from exposure to dusts, gases, vapours and welding fumes. The main identified health effects are pneumonia, asthma, chronic obstructive pulmonary disease (COPD), lung and kidney cancer, metal fume fever (MFF) and lung function changes.

During welding and hot cutting 'hot work' operations, fumes are produced which are collectively known as welding fume. Depending upon the type of welding process being performed, the resultant fume generated is a complex and highly variable mixture of gases and particulates.

Regardless of the length of welding being carried out, all welding fume, including mild steel welding, requires suitable engineering controls to be in place which is usually Local Exhaust Ventilation (LEV) extraction to reduce the exposure to welding fume indoors and, where LEV does not adequately control exposure, it should also be enhanced by using suitable respiratory protective equipment (RPE) to assist with protecting against residual fume.

When welding outdoors appropriate RPE should be used.

Prior to undertaking any welding tasks an appropriate risk assessment should be carried out to ensure expected control measures are in place.

Locate the equipment in a well-ventilated position and keep your head out of the welding fume.

Do not breathe the welding fume.

Ensure the welding zone is well-ventilated and provision should be made for suitable local fume extraction system to be in place.

If ventilation is poor, wear an approved airfed welding helmet or respirator.

Read and understand the Material Safety Data Sheets (MSDS's) and the manufacturer's instructions for metals, consumables, coatings, cleaners and de-greasers.

Do not weld in locations near any de-greasing, cleaning or spraying operations.

Be aware that heat and rays of the arc can react with vapours to form highly toxic and irritating gases.

For further information please refer to the HSE website www.hse.gov.uk for related documentation.



An example of personal fume protection

Precautions against fire and explosion



Warning
Fire Risk

Avoid causing fires due to sparks and hot waste or molten metal.

Ensure that appropriate fire safety devices are available near the welding and cutting area.

Remove all flammable and combustible materials from the welding, cutting and surrounding areas.

Do not weld or cut fuel and lubricant containers, even if empty. These must be carefully cleaned before they can be welded or cut.

Always allow the welded or cut material to cool before touching it or placing it in contact with combustible or flammable material.

Do not work in atmospheres with high concentrations of combustible fumes, flammable gases and dust.

Always check the work area half an hour after cutting to make sure that no fires have begun.

Take care to avoid accidental contact of electrode to metal objects. This could cause arcs, explosion, overheating or fire.



Understand your fire extinguishers

SAFETY INSTRUCTIONS

The working environment

Ensure the machine is mounted in a safe and stable position allowing for cooling air circulation.

Do not operate equipment in an environment outside the laid down operating parameters.

The welding power source is not suitable for use in rain or snow.

Always store the machine in a clean, dry space.

Ensure the equipment is kept clean from dust build up.

Always use the machine in an upright position.

Protection from moving parts

When the machine is in operation keep away from moving parts such as motors and fans.

Moving parts, such as the fan, may cut fingers and hands and snag garments.

Protections and coverings may be removed for maintenance and controls only by qualified personnel after first disconnecting the power supply cable.

Replace the coverings and protections and close all doors when the intervention is finished and before starting the equipment.

Take care to avoid getting fingers trapped when loading and feeding wire during set up and operation.

When feeding wire be careful to avoid pointing it at other people or towards your body.

Always ensure machine covers and protective devices are in operation.

Risks due to magnetic fields



The magnetic fields created by high currents may affect the operation of pacemakers or electronically controlled medical equipment.

Wearers of vital electronic equipment should consult their physician before beginning any arc welding, cutting, gouging or spot welding operations.

Do not go near welding equipment with any sensitive electronic equipment as the magnetic fields may cause damage.

Keep the torch cable and work return cable as close to each other as possible throughout their length.

This can help minimise your exposure to harmful magnetic fields.

Do not wrap the cables around the body.

Handling of compressed gas cylinders and regulators

Mishandling gas cylinders can lead to rupture and the release of high pressure gas.



Always check the gas cylinder is the correct type for the welding to be carried out.

Always store and use cylinders in an upright and secure position.

All cylinders and pressure regulators used in welding operations should be handled with care.

Never allow the electrode, electrode holder or any other electrically “hot” parts to touch a cylinder.

Keep your head and face away from the cylinder valve outlet when opening the cylinder valve.

Always secure the cylinder safely and never move with regulator and hoses connected.

Use a suitable trolley for moving cylinders.

Regularly check all connections and joints for leaks.

Full and empty cylinders should be stored separately.

Never deface or alter any cylinder

SAFETY INSTRUCTIONS

RF Declaration

Equipment that complies with directive 2014/30/EU concerning electromagnetic compatibility (EMC) and the technical requirements of EN60974-10 is designed for use in industrial buildings and not those for domestic use where electricity is provided via the low voltage public distribution system. Difficulties may arise in assuring class A electromagnetic compatibility for systems installed in domestic locations due to conducted and radiated emissions. In the case of electromagnetic problems, it is the responsibility of the user to resolve the situation. It may be necessary to shield the equipment and fit suitable filters on the mains supply.

LF Declaration

Consult the data plate on the equipment for the power supply requirements. Due to the elevated absorbance of the primary current from the power supply network, high power systems affect the quality of power provided by the network. Consequently, connection restrictions or maximum impedance requirements permitted by the network at the public network connection point must be applied to these systems. In this case, the installer or the user is responsible for ensuring the equipment can be connected, consulting the electricity provider if necessary.

Materials and their disposal

Welding equipment is manufactured with BSI published standards meeting CE requirements of materials which do not contain any toxic or poisonous materials dangerous to the operator. Do not dispose of the equipment with normal waste. The European Directive 2012/19/EU on Waste Electrical and Electronic Equipment states that electrical equipment that has reached its end of life must be collected separately and returned to an environmentally compatible recycling facility for disposal.

For more detailed information please refer to the HSE website www.hse.gov.uk

PRODUCT OVERVIEW

The Jasic TIG inverter range of welding machines have been designed as integrated and portable welding power supply units incorporating the most advanced IGBT inverter technology in power electronics with easy operation and adjustment due to friendly user interface.

Unique electric structure and air channel design in this series of machines can speed up the heat dissipation of the power device as well as improving the duty cycles of the machines. The unique heat rejection efficiency of the air channel can effectively prevent the power devices and control circuits from being damaged by the dust absorbed by the fan and thereby, the reliability of the machine is greatly improved.

The entire machine is in form of coherent streamline, the front and rear panels are naturally integrated via large-radian transition manner. The front panel and the rear panel of the machine and the handle are coated with rubber oil, so the machine has soft texture, good hand feeling that feels warm and comfortable to hold.

Jasic TIG 200 Pulse PFC Product Features:

- Compact size, lightweight and modern design
- The 200P has wide voltage input of 95V - 265V
- PFC Energy Saving pulse TIG inverter welder
- DC pulse TIG with excellent HF arc ignition which offers high reliability arc starting
- Suitable for a wide range of DC MMA welding electrodes
- Advanced IGBT inverter technology with digital control panel with parameter autosaving
- 40Khz inverter frequency, high efficiency
- Full control of pulse parameters in TIG mode
- Full adjustable upslope/downslope in TIG mode including pre/post flow gas control
- Built in hot start arc ignition function which ensures excellent arc ignition
- Built in self adaptive arc force technology which maintains the optimum MMA arc conditions during operation even with long welding cables offering excellent weld characteristics
- Remote control output suitable for foot pedal use
- Auto compensation for mains voltage fluctuation
- Easy arc starting, low spatter, stable current which offers good weld bead shape
- High quality tactile finish to mouldings and handle



TECHNICAL SPECIFICATIONS

Technical Parameter		Unit	TIG 200P PFC
Rated input voltage		V	95-265V AC 50/60Hz
Input current I _{eff}	115V	A	27.7
	230V		14.2
Welding current range	MMA	A	10 – 125 (115V)
		A	10 – 180 (230V)
	TIG	A	10 – 160 (115V)
		A	10 – 200 (230V)
No load voltage	MMA	V	65
	TIG		65
Duty cycle	MMA	%	125@60 (115V)
			180@25 (230V)
	TIG		160@60 (115V)
			200@30 (230V)
Pre flow time		S	0.1 ~ 2.0
Initial current		A	10 ~ 200
Upslope time		A	0 ~ 10
Background current (pulse mode)		%	10 ~ 100
Pulse frequency		Hz	0.5 ~ 200
Pulse width/duty		%	10 ~ 90
Downslope time		S	0 ~ 10
Final current		A	10 ~ 200
Post flow time		S	1 ~ 20
Spot Time		S	0.2 ~ 5.0
Efficiency		%	82
Idle State Power		W	< 50
Housing protection grade		IP	21S
Power factor		cosφ	0.99
Insulation grade		-	F
Arc ignition mode		-	HF arc ignition
Standard		-	IEC60974-1
Noise		Db	<70
Operating temperature range		°C	-10 ~ +40
Storage temperature range		°C	-25 ~ +55
Size	Without handle	mm	420 x 135 x 235
	With handle		420 x 135 x 277
Weight		Kg	7.2
Remote control option		-	Yes

Please Note

Due to variations in manufactured products all claimed performance ratings, capacities, measurements, dimensions and weights quoted are approximate only. Achievable performance and ratings when in use can depend upon correct installation, applications and use along with regular maintenance and service.

CONTROLS

Front view Jasic TIG 200P PFC

1. Digital display
2. Parameter selection area
3. Parameter selector switch
4. 2T/4T and spot mode control switch
5. "+" Output terminal*: To connect the work clamp
6. "-" Output terminal*: To connect the TIG torch
7. Gas outlet fitting for the gas hose of the TIG torch
8. 5 pin remote connection socket
9. Cooling air vent
10. Parameter adjustment encoder dial
11. Welding process LED's
12. Process selector switch
13. Mains LED (bottom) and overheat LED (top)

* Panel socket size is 35/50mm

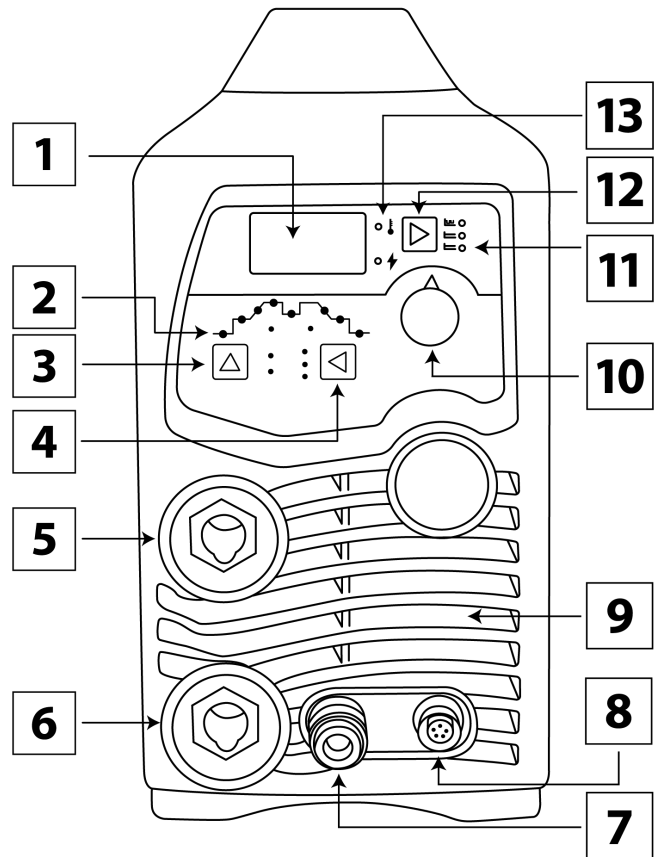

Rear view Jasic TIG 200P PFC

14. Power switch
15. Mains input cable
16. Air vent and fan
17. Input shield gas

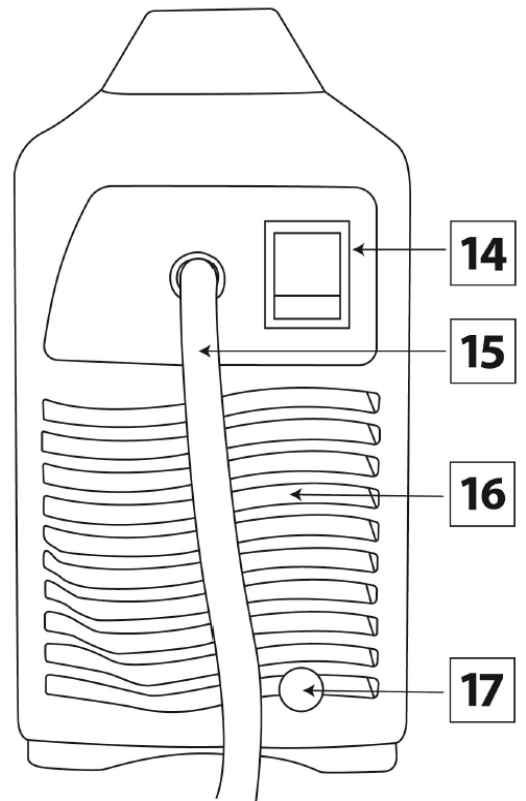

CONTROLS

Control panel view Jasic TIG 200P PFC

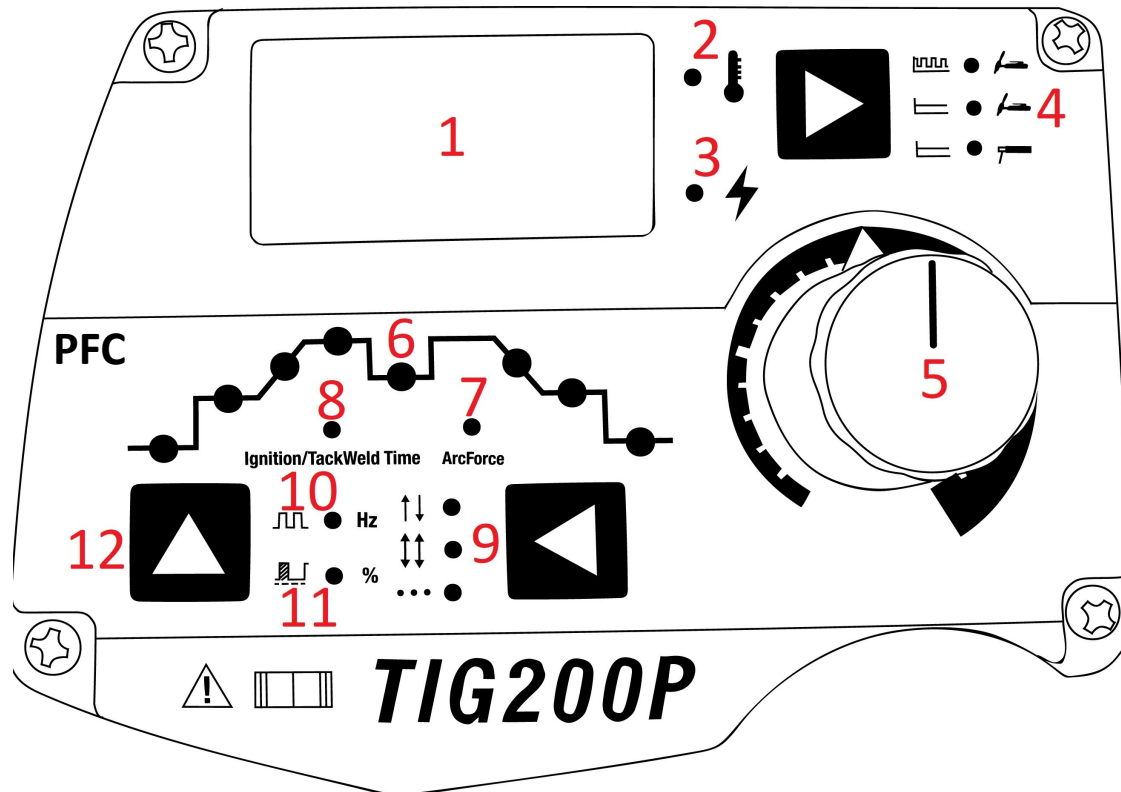

1. Digital meter: Displays pre-set and actual current before and during welding. Also used to display any error message codes
2. Overheat LED: This LED will be lit when the machine enters overheat conditions. Welding will cease whilst this LED is lit
3. Power LED: This LED will be lit when the mains supply is connected and the mains switch is on
4. Welding mode selection zone: Welding mode selection zone contains welding mode indicators and selection key. Welding modes include DC TIG, Pulse TIG, DC MMA. Press the welding mode selection key to choose the according welding mode. The welding mode selected will be indicated by the corresponding LED being lit and there is welding current flowing
5. Adjustment knob: Rotate this control dial to increase or decrease selected parameters
6. Parameter selection area: Pushing the parameter selection button (12) will highlight the parameter LED which can then be adjusted with the rotary dial (5)
7. Arc force LED: When selected and lit, arc force in MMA mode can be adjusted.
Please Note: In TIG mode this LED indicates that remote control has been activated, which is required when using a remote control device such as a foot pedal (see page 24 for further details)
8. Ignition/Spot LED: MMA arc ignition and spot weld time indicator
9. Latch/Spot selector switch: Use this selector to choose 2T, 4T or spot mode
10. Frequency LED: When lit the pulse frequency can be adjusted
11. Pulse duty LED: When lit the time on peak current during each pulse can be adjusted
12. Parameter selection switch: Pressing this switch will highlight the LED of the parameter to be adjusted in the selection area (6) via the rotary control dial (5)

CONTROLS

Control panel functions Jasic TIG 200P PFC

Press the relevant selector switch until the LED is lit against the required parameter.

The parameter can then be adjusted.

Note: The JT-200P-PFC has inbuilt autosave memory, so when you shutdown the machine, on switch on it will go back to the last weld setup.

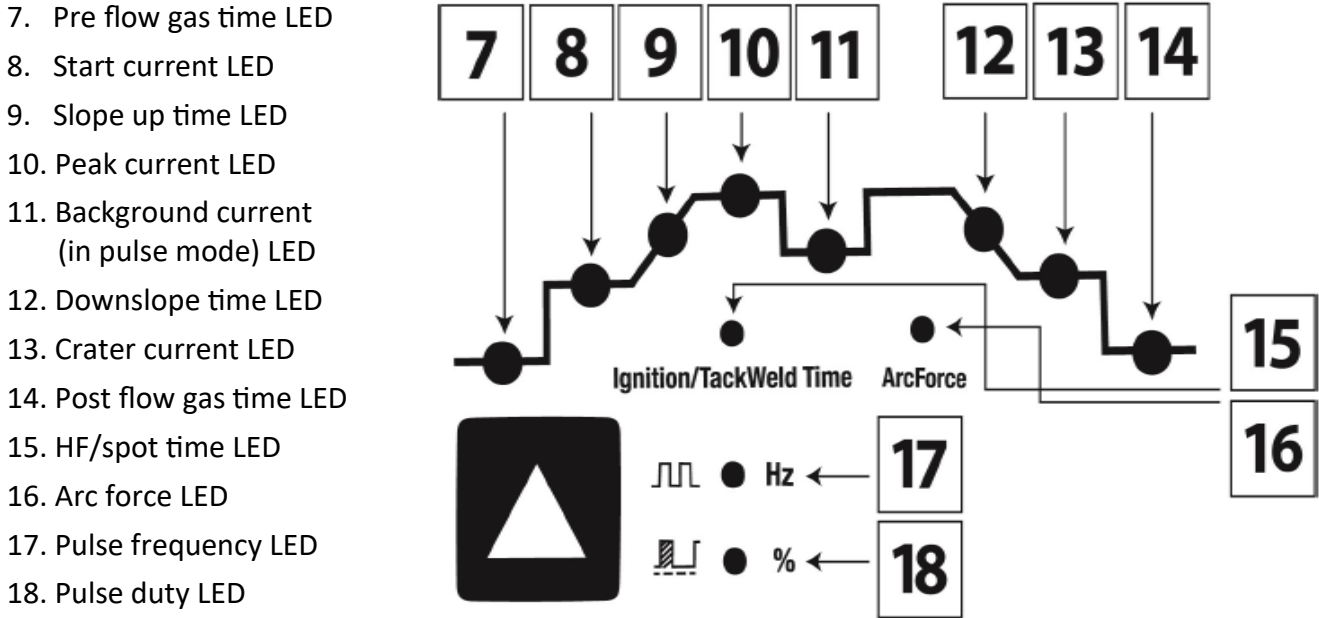
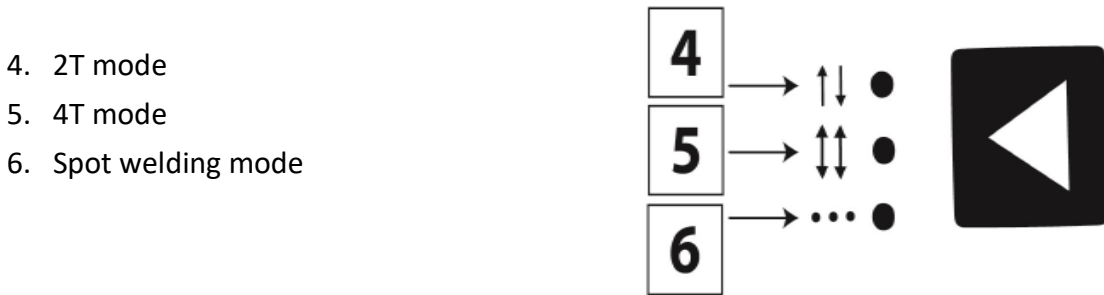

CONTROLS

Control panel functions Jasic TIG 200P PFC

Parameter autosaving

The parameters having been adjusted will be autosaved in the parameter group currently used (no autosaving will be done in the case that no operation is done after parameters are adjusted and the machine was turned off in 5 seconds time). When the machine is next turned on, the parameters in this parameter group are just the parameters used last time. When the welding mode and operation mode are reselected, autosaving will be done in 10 seconds. No special save key and manual saving operation is available for this machine.

Protection error codes

When the overcurrent indicator illuminates and the digital meter displays "E-1" it indicates that overcurrent occurs. Restart the machine and welding can be continued.



When the under voltage indicator illuminates and the digital meter displays "E-2" it indicates that the mains voltage is overly low and welding can be recovered when the mains voltage goes into normal.



When the overheating indicator illuminates and the digital meter displays "E-3" it indicates that welding is forced to stop because the main circuit of the machine gets overheated. In this condition, it is unnecessary to turn off the machine but just wait a few minutes and then welding can be continued.



When the current sensor fails and the digital meter displays "E-4" welding may still be carried out. However, the current value at this time is inaccurate.



INSTALLATION

Unpacking

Check the packaging for any signs of damage.

Carefully remove the machine and retain the packaging until the installation is complete.

Location

The machine should be located in a suitable position and environment. Care should be taken to avoid moisture, dust, steam, oil or corrosive gases.

Place on a secure level surface and ensure that there is adequate clearance around the machine to ensure natural airflow.

Input connection

Before connecting the machine you should ensure that the correct supply is available.

Details of the machine requirements can be found on the data plate of the machine or in the technical parameters shown in the manual.

The equipment should be connected by a suitably qualified competent person. Always ensure the equipment has a proper grounding.

Never connect the machine to the mains supply with the panels removed.

Output connections

Electrode polarity

In general when using manual arc welding electrodes the electrode holder is connected to the positive terminal and the work return to the negative terminal.

"+" output terminal: For MMA connect the electrode holder

"-" output terminal: For MMA connect the work return lead

Always consult the electrode manufacturer's data sheet if you have any doubts.

When using the machine for TIG welding the TIG torch should be connected to the negative terminal and the work return to the positive terminal.

"+" output terminal: For TIG connect the work return lead

"-" output terminal: For TIG connect the TIG torch

Gas connections

Connect the gas hose to the regulator/flowmeter located on the shield gas cylinder and connect the other end to the machine.

Please Note:

Check these power connections daily to ensure they have not become loose otherwise arcing may occur when used under load.

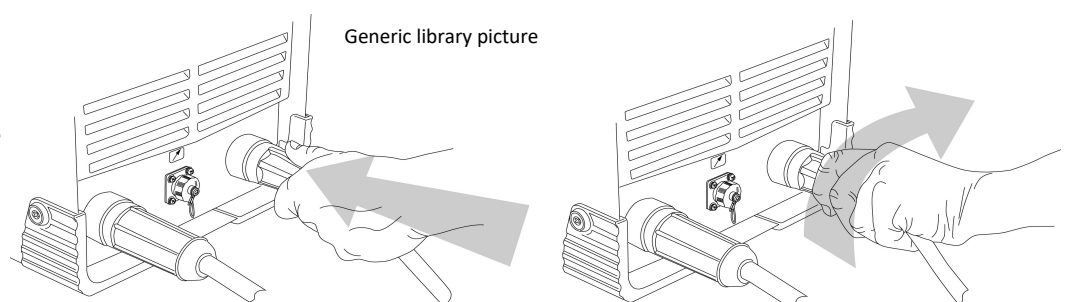

INSTALLATION

MMA welding

Insert the cable plug with electrode holder into the “+” socket on the front panel of the welding machine and tighten it clockwise.

Insert the cable plug of the work return lead into the “-” socket on the front panel of the welding machine and tighten it clockwise. Example shown below:

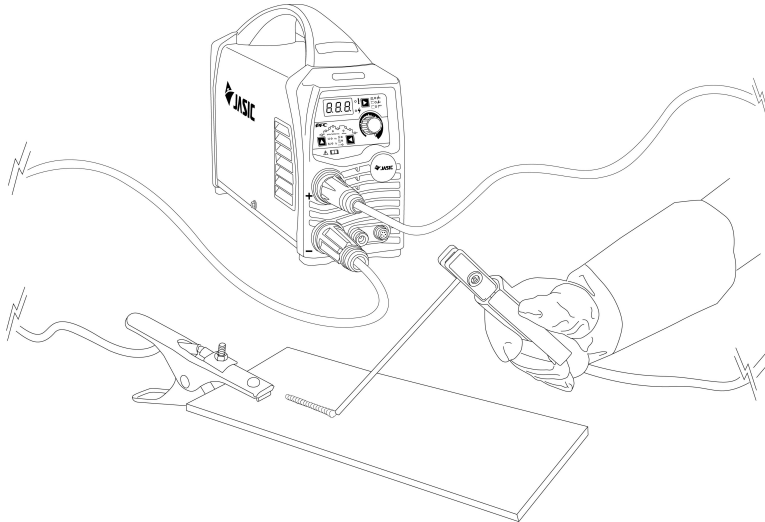

TIG welding

Insert the cable plug with the work clamp into the “+” socket on the front panel of the welding machine and tighten it clockwise.

Insert the cables plug of the TIG torch into the “-” socket on the front panel of the machine and tighten clockwise. Connect the gas quick connector into the outlet on the machine front.

Connect the torch switch plug into the socket on the front panel.

Connect the gas hose to the regulator/flowmeter located on the shield gas cylinder and connect the other end to the machine. Example shown below:

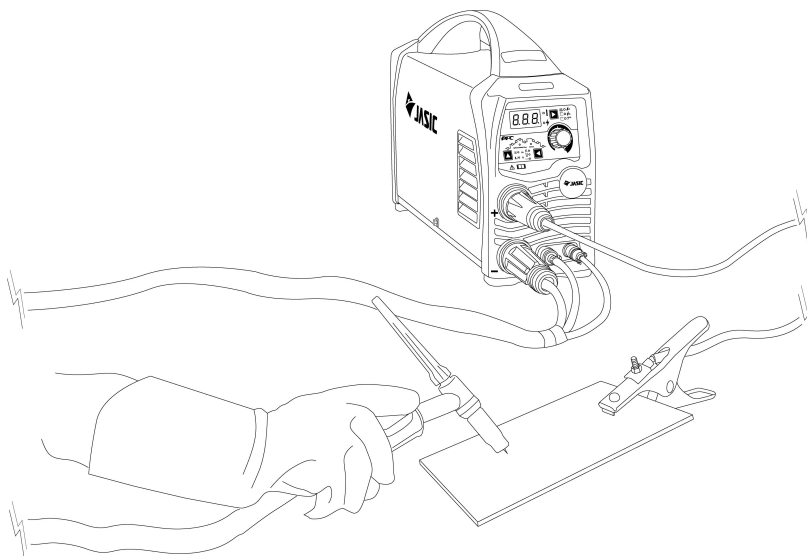

Before starting any welding activity ensure that you have suitable eye protection, protective clothing and all required PPE. Also take the necessary steps to protect any persons within the area.

OPERATION - MMA



Before starting any welding activity ensure that you have suitable eye protection and protective clothing. Also take the necessary steps to protect any persons within the welding area.

MMA welding mode

MMA (Manual Metal Arc), SMAW (Shielded Metal Arc Welding) or just Stick Welding.

Stick welding is an arc welding process which melts and joins metals by heating them with an arc between a covered metal electrode and the work.

Shielding is obtained from the electrode outer coating, often called flux. Filler metal is primarily obtained from the electrode core.

The electrodes outer coating called flux assists in creating the arc and provides a shielding gas on cooling forms a slag covering to protect the weld from contamination.

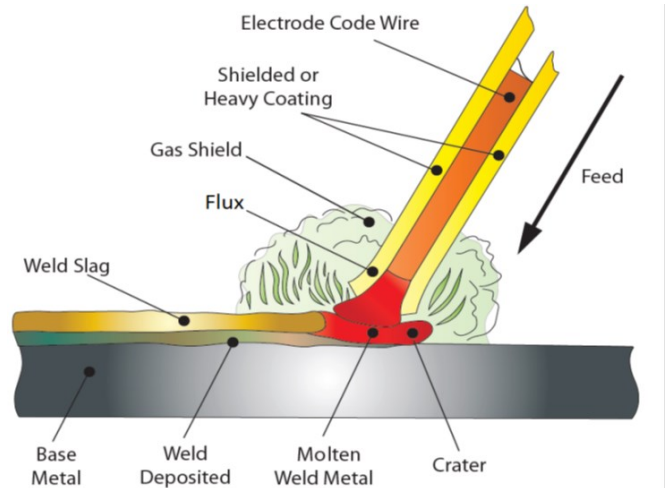

When the electrode is moved along the work piece at the correct speed the metal core deposits a uniform layer called the weld bead.

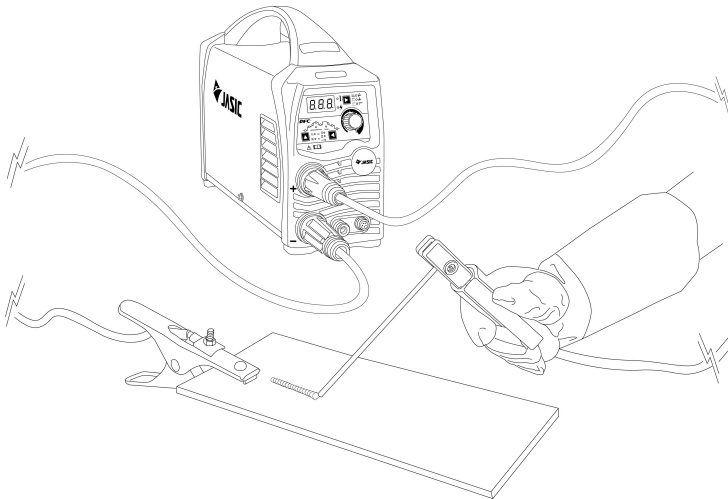

MMA operation steps

After connecting the welding leads as detailed you will need to switch the power switch on the back panel of the machine to "ON".

Select MMA mode by pressing the welding mode selecting key and MMA can be carried out. There is voltage output at both output terminals.

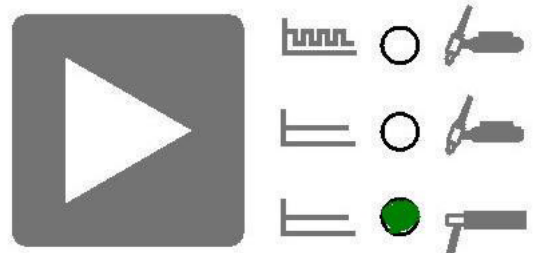

At this time, the voltage indicator illuminates and welding can be carried out.



OPERATION - MMA



Before starting any welding activity ensure that you have suitable eye protection and protective clothing. Also take the necessary steps to protect any persons within the welding area.

MMA operation steps

Select the welding current setting function by pressing the welding parameter selecting key (A) and welding current in MMA can be set using the rotary dial. Welding current setting can be carried out during welding.

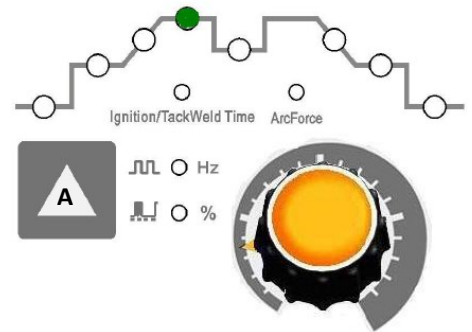

Select the arc ignition time setting function (this function also changes spot welding time when setting function is in TIG spot welding mode) by pressing the welding parameter selection key (A) the arc ignition time in MMA can be set using the rotary dial. Arc ignition time setting can be carried out during welding.

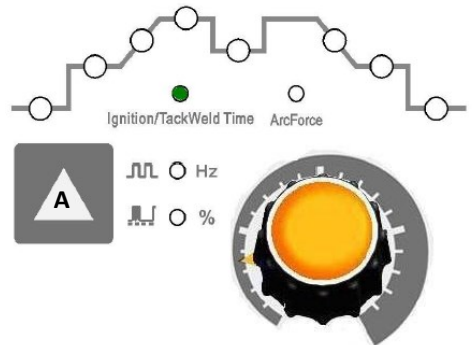

Select the arc force current setting function by pressing the welding parameter selection key (A), and arc force current in MMA can be set using the rotary dial. The arc force current setting can also be adjusted during welding.

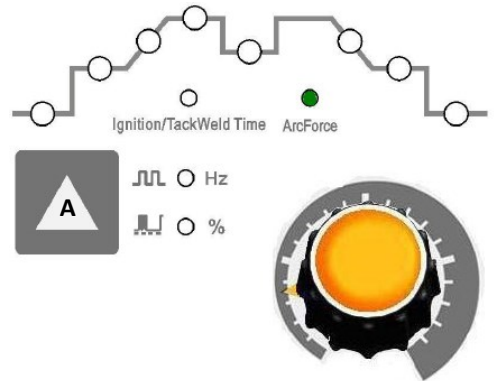

If the secondary cables (welding cable and earth cable) are long, select cable with larger cross-section to reduce the voltage drop.

Preset the welding current according to the type and size of the electrode, clip the electrode and then welding can be carried out by short circuit arc ignition. For welding parameters, please refer to the opposite table.

Electrode Diameter (mm)	Recommended Welding Current (A)	Recommended Welding Voltage (V)
1.0	20 ~ 60	20.8 ~ 22.4
1.6	44 ~ 84	21.76 ~ 23.46
2.0	60 ~ 100	22.4 ~ 24
2.5	80 ~ 120	23.2 ~ 24.8
3.2	108 ~ 148	24.32 ~ 24.92
4.0	140 ~ 180	24.6 ~ 27.2

OPERATION - TIG



Before starting any welding activity ensure that you have suitable eye protection and protective clothing. Also take the necessary steps to protect any persons within the welding area.

TIG welding mode

Terms used: TIG – Tungsten Inert Gas, GTAW – Gas Tungsten Arc Welding.

TIG welding is an arc welding process that uses a non-consumable tungsten electrode to produce the heat for welding.

The weld area is protected from atmospheric contamination by a shielding gas (usually an inert gas such as argon or helium) and a filler rod matching the base material is normally used, though some welds, known as autogenous welds, are carried out without the need for filler wire.

TIG process can be either DC or AC modes:

DC - Direct current for welding steel, stainless steel, copper etc.

AC - Alternating current for welding aluminium and it's alloys.

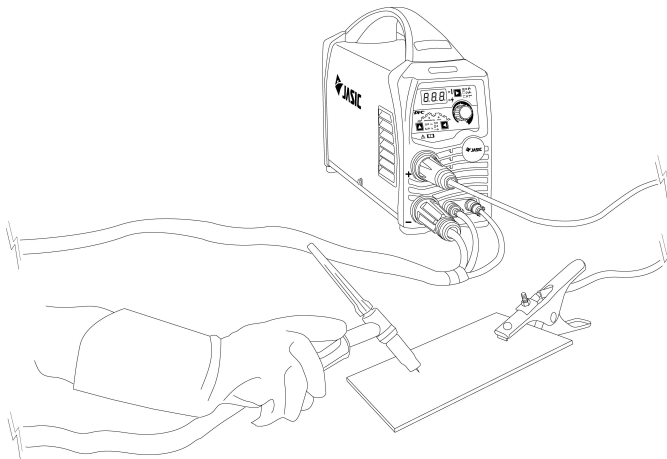
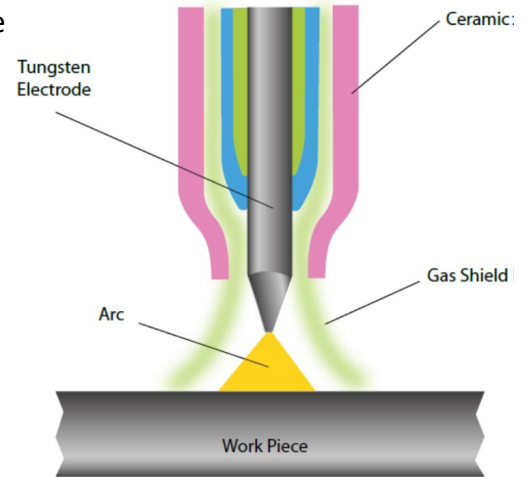

Connect the TIG torch connector to the “-” quick socket on the machine panel and tighten it clockwise.

Connect the switch plug on the TIG torch to the corresponding socket on the machine panel, this is a quick connector so it is not necessary to turn the plug.

Insert the quick plug on the work return cable into the “+” quick socket on the machine panel and tighten it clockwise. Clamp the work clamp to the work piece.

Connect the gas hose of the TIG torch to the quick connector on the machine front.

Connect the gas hose to the gas inlet on the back panel of the machine. The other end of the supply hose connects to the gas regulator on the cylinder.

Press the torch trigger briefly, the solenoid valve will operate and gas will flow.

Adjust the welding current according to the thickness of the work piece to be welded (for a guide to welding parameters, please refer to the table below).

Hold the torch 2-4mm away from the work piece and then press the torch trigger. After arc is ignited, the HF discharge will cease, the current will maintain the preset value and welding can be carried out.

After releasing the torch trigger, the welding arc stops but gas continues flowing for the post flow time and welding ends.

The amperage guide for TIG welding tungsten sizes can vary depending on material, work piece thickness, welding position and joint form.

Tungsten Size	DC – Electrode Negative
1.0mm	15 – 80A
1.6mm	70 – 150A
2.4mm	150 – 250A
3.2mm	250A – 400A
4.0mm	400A – 500A
6.0mm	750A – 1000A

OPERATION - TIG



Before starting any welding activity ensure that you have suitable eye protection and protective clothing. Also take the necessary steps to protect any persons within the welding area.

TIG operation steps

Select the DC TIG mode by pressing the welding mode selecting key.

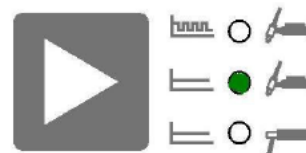

Select the 2T mode by pressing the operation mode selecting key.



Select the pre flow time setting function by pressing the welding parameter selecting key (A) and set the pre flow time using the rotary dial.

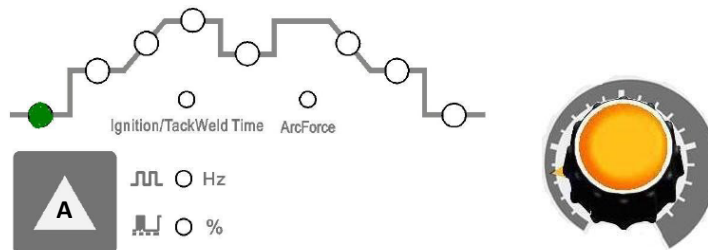

Select the initial current setting function by pressing the welding parameter selecting key (A) and set the initial current using the rotary dial.

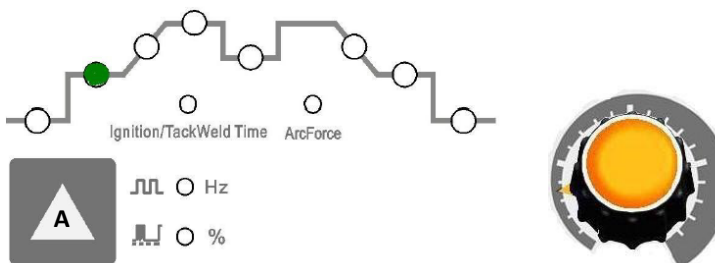

Select the upslope time setting function by pressing the welding parameter selecting key (A) and set the upslope time using the rotary dial.

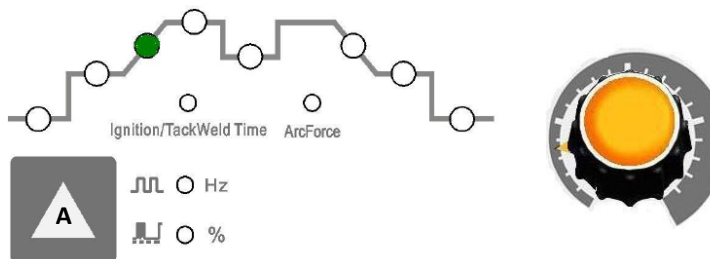

Select the welding current setting function by pressing the welding parameter selecting key (A) and set the welding current using the rotary dial.

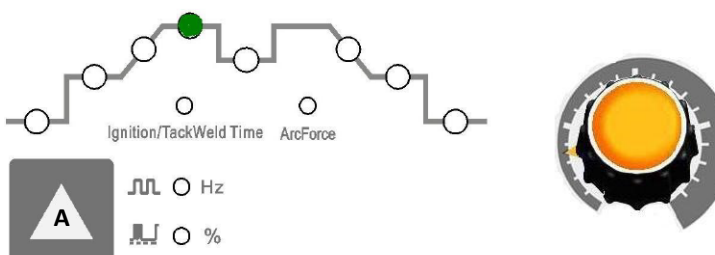

OPERATION - TIG



Before starting any welding activity ensure that you have suitable eye protection and protective clothing. Also take the necessary steps to protect any persons within the welding area.

TIG operation steps

Select the downslope time setting function by pressing the welding parameter selecting key (A) and set the downslope time using the rotary dial.

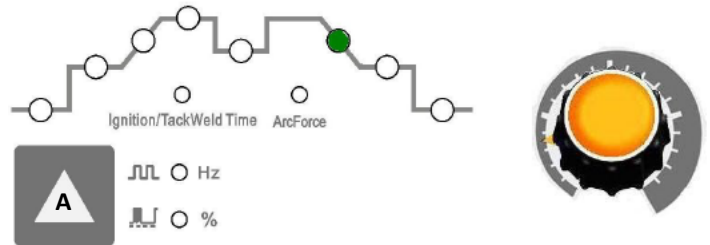

Select the crater current setting function by pressing the welding parameter selecting key (A) and set the pilot arc current using the rotary dial.

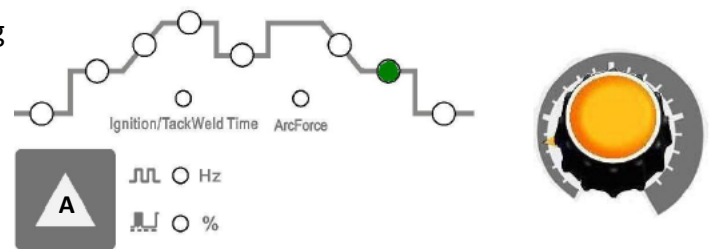

Select the post flow time setting function by pressing the welding parameter selecting key (A) and set the post flow time using the rotary dial.

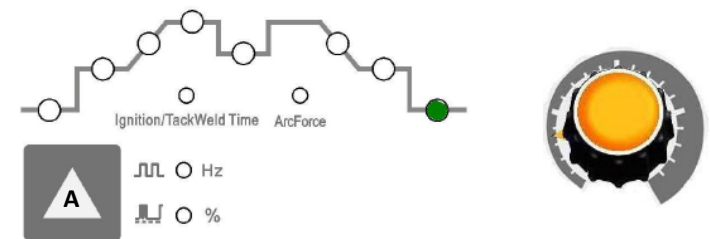

After the parameters are set appropriately, open the gas valve of the cylinder and adjust the gas regulator to the desired flow value.

Keep the torch 2-4mm away from the work piece and then press the torch trigger, the solenoid valve will operate, gas will flow and HF starts.

After arc is ignited, the HF discharge rustling disappears, the current rises up to the preset value and welding can be carried out. After releasing the torch trigger, the current begins to decrease automatically to the crater current value. Then, arc stops with gas kept flowing for the post flow time and welding ends.

Pulsed TIG

Select the pulsed TIG mode by pressing the welding mode selecting key.

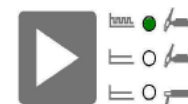

Select the 2T mode by pressing the operation mode selecting key.



Proceed with the set up as for standard TIG. The welding current setting now becomes the peak welding current of the pulse. The next step will allow setting of the base current. This is only allowed when the pulse mode is selected.

OPERATION - TIG



Before starting any welding activity ensure that you have suitable eye protection and protective clothing. Also take the necessary steps to protect any persons within the welding area.

TIG operation steps

Select the peak welding current setting function by pressing the welding parameter selecting key (A) and set the peak welding current using the rotary dial.

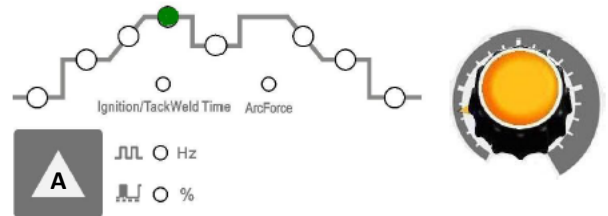

Select the base current setting function by pressing the welding parameter selecting key (A) and set the base current using the rotary dial.

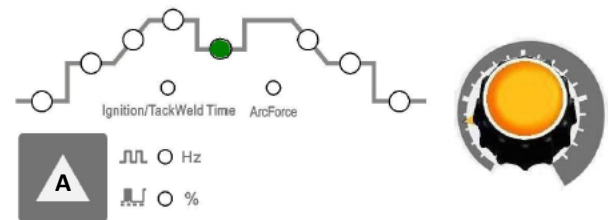

Select the downslope time, crater current and post flow gas time as standard TIG.

Select pulse duty ratio setting function by pressing the welding parameter selecting key (A) and set the pulse duty ratio using the rotary dial.

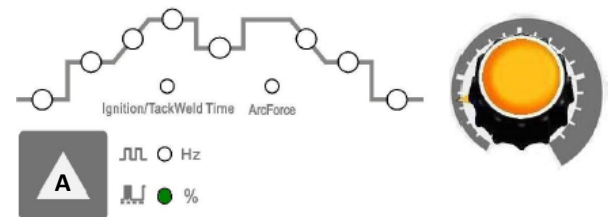

Select pulse frequency setting function by pressing the welding parameter selecting key (A) and set the pulse frequency using the rotary dial.

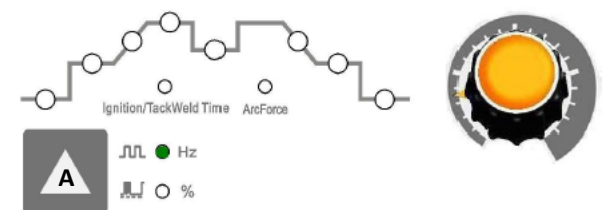

Pulsing the welding arc in DC TIG welding offers a number of advantages, including lower heat input and consequently reduces distortion and warpage when working with thin materials. Pulse TIG also allows for greater control of the weld pool, and can increase weld penetration, welding speed, and quality.

After the parameters are set appropriately, open the gas valve of the cylinder, and adjust the gas regulator to the desired gas flow.

Keep the torch 2-4mm away from the work piece and then press the torch trigger.

Gas will flow followed by the HF and the arc is ignited.

Once the arc is ignited the HF will cease and the current rises up to the preset value and welding can be carried out.

After releasing the torch trigger, the current begins to decrease automatically to the crater current value. Then, arc stops with gas keeping flowing for the post flow time and welding ends.

OPERATION - TIG



Before starting any welding activity ensure that you have suitable eye protection and protective clothing. Also take the necessary steps to protect any persons within the welding area.

TIG operation steps

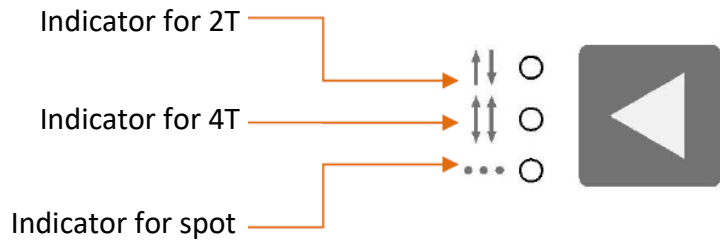

2T (normal trigger control)

This light will illuminate when the power source is in 2T welding mode. In this mode, the torch trigger must remain depressed for the welding output to be active.

Press and hold the torch trigger to activate the power source (weld).

Release the torch trigger switch to cease welding.

4T (latch trigger control)

This light will illuminate when the power source is in 4T welding mode.

This mode of welding is mainly used for long welding runs to reduce operator fatigue. In this mode the operator can press and release the torch trigger and the output will remain active. To stop welding, the trigger switch must again be depressed and released. This function eliminates the need for the operator to hold the torch trigger.

Spot welding

Select the spot welding time setting function by pressing the welding parameter selecting key (A) and set the spot welding time using the rotary dial.

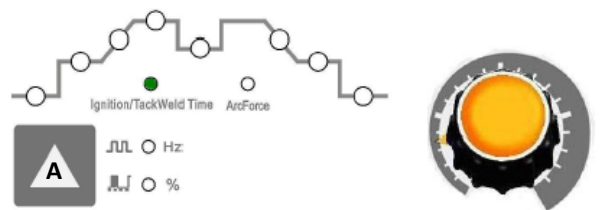

Operation steps in spot welding

Keep the torch 2-4mm away from the work piece.

Press the torch trigger, gas valve opens and HF starts and this ignites the arc.

When the arc is established the HF stops and the current goes to the preset value.

Welding begins and it ends when the spot welding time is up.

There is no current upslope and downslope in spot welding mode.

TIG REMOTE CONTROL SET-UP PROCEDURE

The 5 pin remote control socket located on the front panel is used to connect a TIG torch trigger switch and/or torch mounted current adjustment dial as well as a foot pedal or similar remote device.

Remote plug wiring

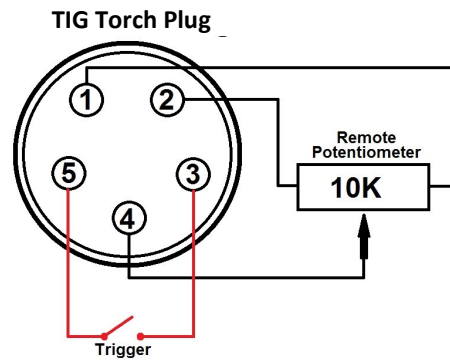

Pin	Description
1	Potentiometer max
2	Potentiometer min
3	Torch switch
4	Potentiometer wiper
5	Torch switch

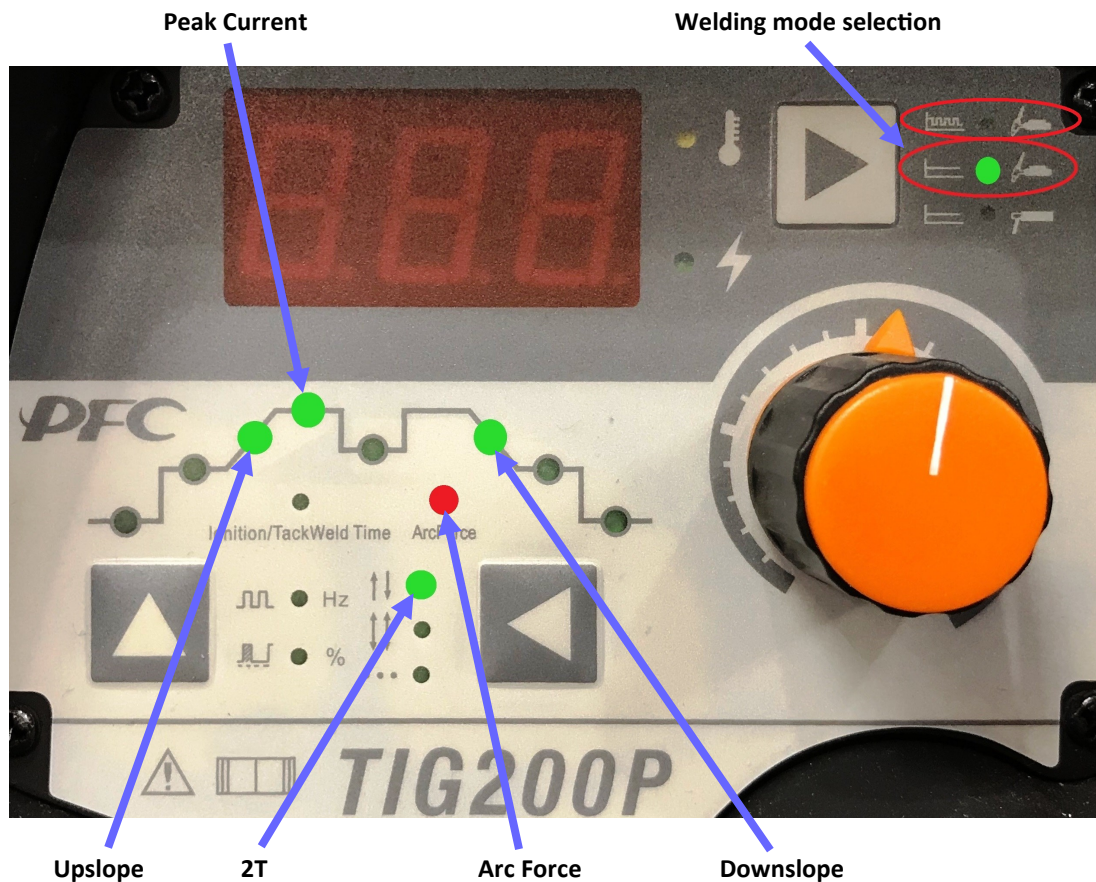

Remote device activation

1. Turn the machine ON.
2. Set machine to either TIG standard or TIG pulse mode in the welding mode selection area.
3. Set peak current to 200amps.*
4. Place upslope and downslope time to 0 (zero).
5. Set machine to 2T trigger mode.

Press and hold the trigger switch for 7 seconds until the front panel Arc Force indicator illuminates. Remote current control is now active. (* Setting the current to 200A allows full range current adjustment via the remote device connected).

Please note:

- The maximum output current must be set on the power source control panel by the user prior to the foot control being connected.
- Remote control deactivation is done by pressing the trigger switch for 7 seconds until the Arc Force indicator turns off which indicates that you are now out of remote current control mode.

GUIDE TO MMA WELDING



Before starting any welding activity ensure that you have suitable eye protection and protective clothing. Also take the necessary steps to protect any persons within the welding area.

Notes for the welding beginner

This section is designed to give the beginner who has not previously done any welding some information to get them going. The simplest way to start is to practice by running weld beads on a piece of scrap plate. Start by using mild steel (paint free) plate of 6.0mm thick and using 3.2mm electrodes. Clean any grease, oil and loose scale from the plate and fix firmly to your work bench so that welding can be carried out. Make sure that the work return clamp is secure and making good electrical contact with the mild steel plate, either directly or through the work table. For best results always clamp the work lead directly to the material being welded, otherwise you may experience a poor electrical circuit.

Welding position

When welding, ensure you place yourself in a comfortable position for welding and your welding application before you begin to weld. This may be by sitting at a suitable height which often is the best way to weld, ensuring you are relaxed and not tense. A relaxed posture will ensure the welding task becomes much easier.

Please ensure you always wear suitable PPE and use suitable fume extraction when welding.

Place the work so that the direction of welding is across, rather than to or from your body.

The electrode holder lead should always be clear of any obstruction so that you can move your arm freely along as the electrode burns down. Some experienced welders prefer to have the welding lead over their shoulder, this allows greater freedom of movement and can reduce the weight from your hand. Always inspect your welding equipment, welding cables and electrode holder before each use to ensure it is not faulty or worn as you may be at risk of an electric shock.

MMA process features and benefits

The versatility of the process and the skill level required to learn along with the basic simplicity of the equipment make the MMA process one of the most common used throughout the world.

The MMA process can be used to weld a wide variety of materials and is normally used in the horizontal position but can be used in vertical or overhead with the correct selection of electrode and current. In addition, it can be used to weld at long distances from the power source subject to the correct cable sizing. The self-shielding effect of the electrode coating makes the process suitable for welding in external environments. It is the dominant process used in maintenance and repair industries and is used extensively in structural and fabrication work.

The process is well able to cope with less than ideal material conditions such as dirty or rusty material. Disadvantages of the process are the short welds, slag removal and stop/starts which lead to poor weld efficiency which is in the region of 25%. The weld quality is also highly dependent on the skill of the operator and many welding problems can exist.

GUIDE TO MMA WELDING



Before starting any welding activity ensure that you have suitable eye protection and protective clothing. Also take the necessary steps to protect any persons within the welding area.

MMA process tips and guides

Typical welder set up

1. Electrode holder
2. Work return clamp
3. Work piece
4. Weld material covered by electrode flux or slag
5. Electrode
6. Distance from work to electrode (arc length)

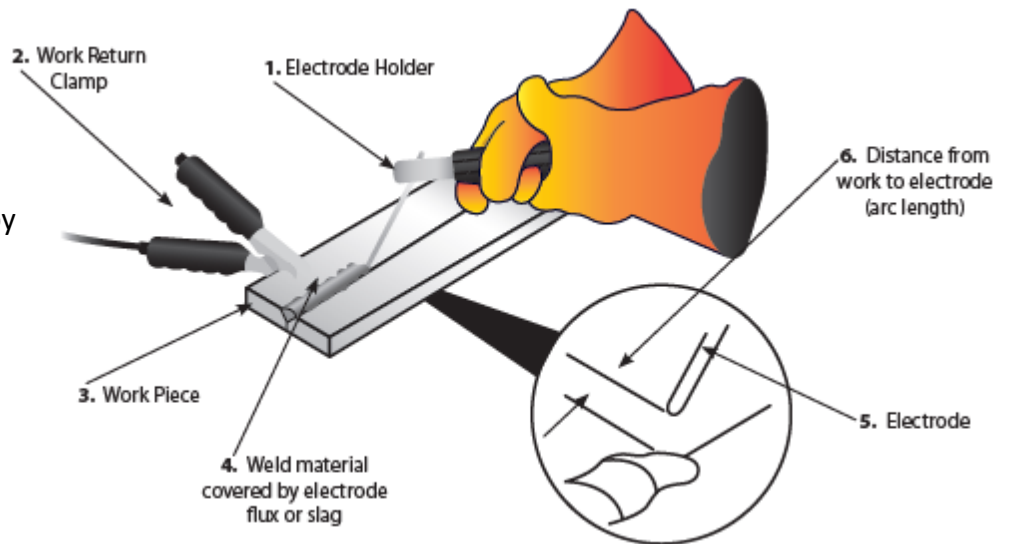

Welding current will flow in the circuit as soon as the electrode contacts the work piece. The welder should always ensure a good connection of the work clamp. The nearer the clamp is placed to the welding area the better.

When the arc is struck the distance between the end of the electrode and the work will determine the arc voltage and also affect the weld characteristic. As a guide the arc length for electrodes up to 3.2mm diameter should be around 1.6mm and for electrodes over 3.2mm it will be around 3mm.

Upon completion of the weld the welding flux or slag will need to be removed usually with a chipping hammer and wire brush.

Joint form in MMA

In MMA welding, the common basic joint forms are: butt joint, corner joint, lap joint & T joint.

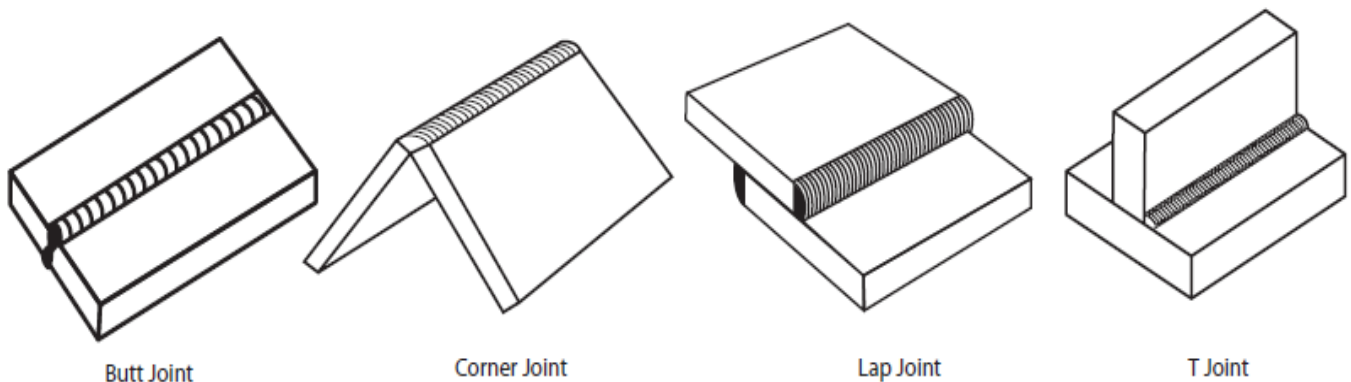

GUIDE TO MMA WELDING



Before starting any welding activity ensure that you have suitable eye protection and protective clothing. Also take the necessary steps to protect any persons within the welding area.

MMA arc striking

Tap technique - Lift the electrode upright and bring it down to strike the work piece. After forming short circuit, quickly lift up about 2~4mm and arc will be ignited. This method is difficult to master.

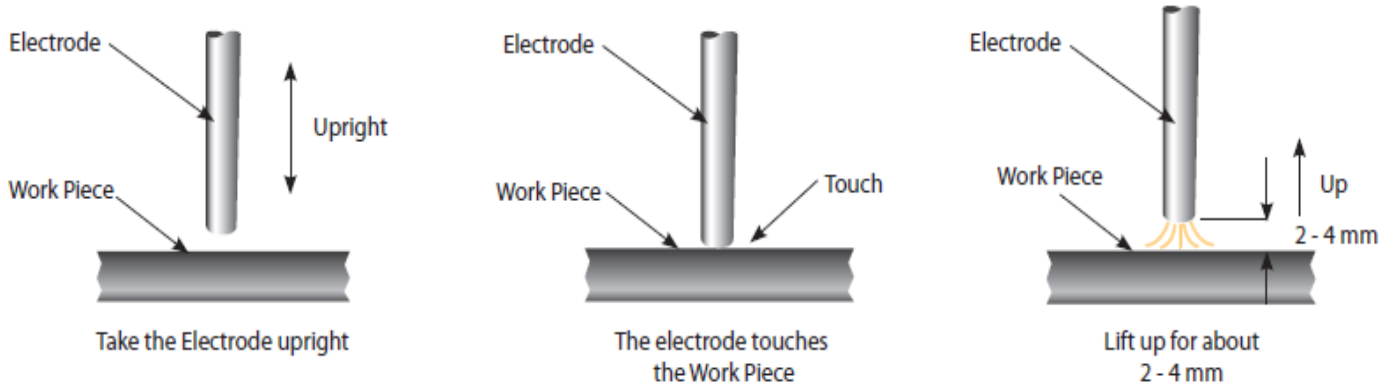

Scratch technique - Drag the electrode and scratch the work piece as if striking a match. Scratching the electrode may cause the arc to burn along the scratch path, so care should be taken to scratch in the weld zone. When the arc is struck adopt the correct welding position.

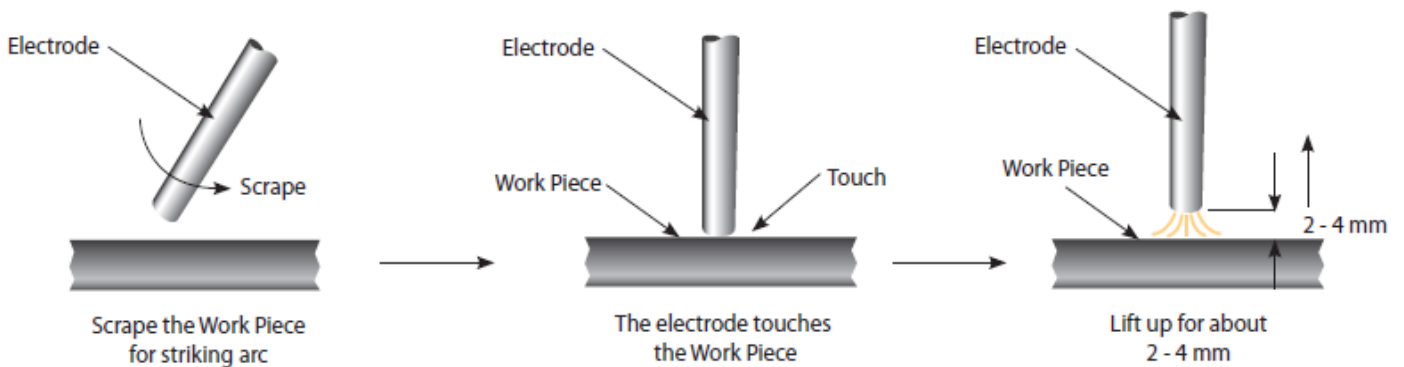

Electrode positioning

Horizontal or flat position

The electrode should be positioned at right angles to the plate and inclined in the direction of travel at around 10°-30°.

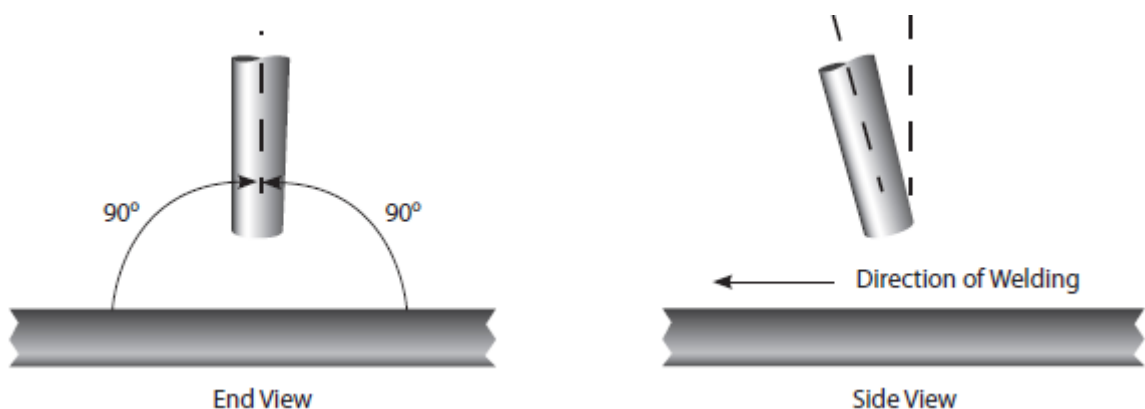

GUIDE TO MMA WELDING



Before starting any welding activity ensure that you have suitable eye protection and protective clothing. Also take the necessary steps to protect any persons within the welding area.

Fillet welding

The electrode should be positioned to split the angle i.e. 45° . Again, the electrode should be inclined in the direction of travel at around 10° - 30° .

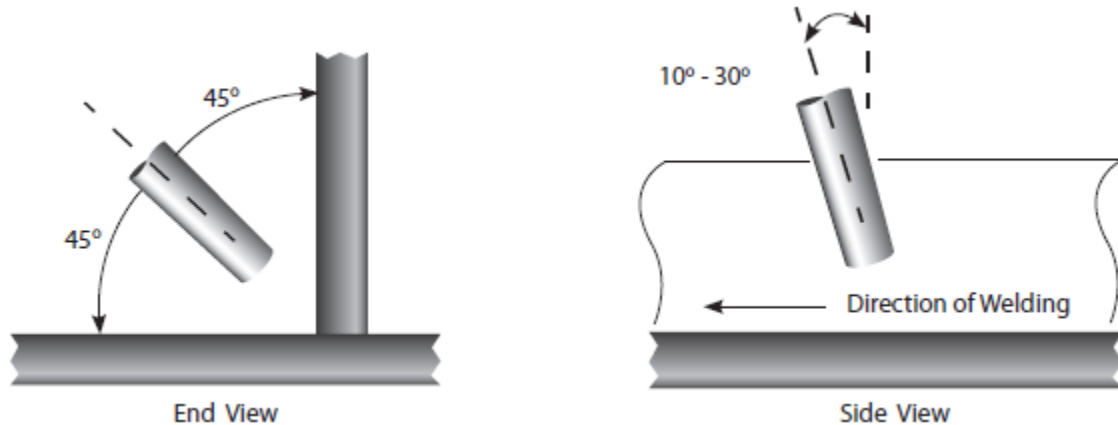

Manipulation of electrode

In MMA welding there are three motions used at the end of electrode:

1. The electrode feeding to the molten pool along axis 3
2. The electrode swings from right and left
3. The electrode moving in the weld direction

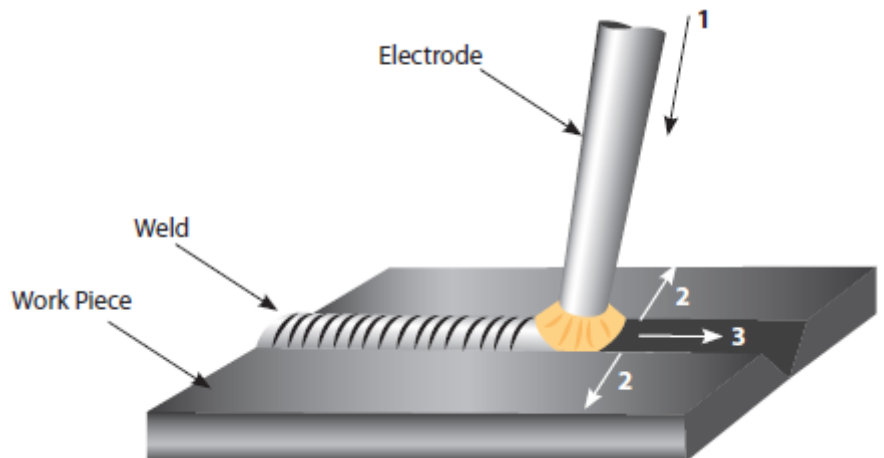

The operator can choose the manipulation of the electrode based on welding joint, welding position, electrode spec, welding current and operation skill etc.

Weld characteristics

A good weld bead should exhibit the following characteristics:

1. Uniform weld bead
2. Good penetration into the base material
3. No overlap
4. Fine spatter level

A poor weld bead will exhibit the following characteristics:

1. Uneven and erratic bead
2. Poor penetration into the base material
3. Bad overlap
4. Excessive spatter levels
5. Weld crater

MMA WELDING PROBLEMS



Before starting any welding activity ensure that you have suitable eye protection and protective clothing. Also take the necessary steps to protect any persons within the welding area.

Arc welding defects and prevention methods

<u>Defect</u>	<u>Possible cause</u>	<u>Action</u>
Excessive spatter (beads of metal scattered around the weld area)	Amperage too high for the selected electrode	Reduce amperage or utilise larger diameter electrode
	Voltage too high or arc length too long	Reduce arc length or voltage
Uneven and erratic weld bead and direction	Weld bead is inconsistent and misses joint due to operator	Operator training required
Lack of penetration – The weld bead fails to create complete fusion between material to be welded, often surface appears okay but weld depth is shallow	Poor joint preparation	Joint design must allow for full access to the root of the weld
	Insufficient heat input	Material too thick Increase the amperage or increase the electrode size and amperage
	Poor weld technique	Reduce travel speed Ensure the arc is on the leading edge of the weld puddle
Porosity – Small holes or cavities on the surface or within the weld material	Work piece dirty	Remove all contaminant from the material i.e. oil, grease, rust, moisture prior to welding
	Electrode is damp	Replace or dry the electrode
	Arc length is excessive	Reduce the arc length
Excessive penetration – The weld metal is below the surface level of the material and hangs below	Heat input too high	Reduce the amperage or use a smaller electrode and lower amperage
	Poor weld technique	Use correct welding travel speed
Burning through – Holes within the material where no weld exists	Heat input too high	Use lower amperage or smaller electrode Use correct welding travel speed
Poor fusion – Failing of weld material to fuse either with the material to be welded or previous weld beads	Insufficient heat level	Increase the amperage or increase the electrode size and amperage
	Poor welding technique	Joint design must allow for full access to the root of the weld Alter welding technique to ensure penetration such as weaving, arc positioning or stringer bead technique
	Work piece dirty	Remove all contaminant from the material i.e. oil, grease, rust, moisture prior to welding

GUIDE TO TIG WELDING



Before starting any welding activity ensure that you have suitable eye protection and protective clothing. Also take the necessary steps to protect any persons within the welding area.

TIG torch body and components

The torch body holds the various welding consumables in place as shown and is covered by either a rigid phenolic or rubberised covering.

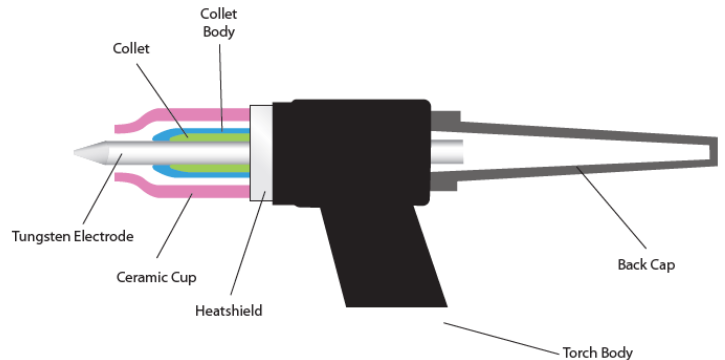

Collet body

 The collet body screws into the torch body. It is replaceable and is changed to accommodate the different size tungstens and their respective collets.

Collets

 The welding electrode (tungsten) is held in the torch by the collet. The collet is usually made of copper or a copper alloy. The collet's grip on the electrode is secured when the torch back cap is tightened in place. Good electrical contact between the collet and tungsten electrode is essential for good welding current transfer.

Gas lens body

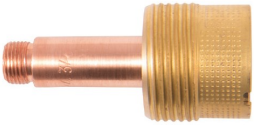
 A gas lens is a device that can be used in place of the normal collet body. It screws into the torch body and is used to reduce turbulence in the flow of shield gas and produce a stiff column of undisturbed flow of shielding gas. A gas lens will allow the welder to move the nozzle further away from the joint allowing increased visibility of the arc. A much larger diameter nozzle can be used which will produce a large blanket of shielding gas. This can be very useful in welding material like titanium. The gas lens will also enable the welder to reach joints with limited access such as inside corners.

Ceramic cups

 Gas cups are made of various types of heat resistant materials in different shapes, diameters and lengths. The cups are either screwed onto the collet body or gas lens body or in some cases pushed in place. Cups can be made of ceramic, metal, metal-jacketed ceramic, glass or other materials. The ceramic type is quite easily broken so take care when putting the torch down.

Gas cups must be large enough to provide adequate shielding gas coverage to the weld pool and surrounding area. A cup of a given size will allow only a given amount of gas to flow before the gas flow becomes disturbed due to the speed of flow. Should this condition exist the size of cup should be increased to allow the flow speed to reduce and once again establish an effective regular shield.

Back cap

The back cap screws into the rear of the torch head and applies pressure to the back end of the collet which in turn forces up against the collet body, the resulting pressure holds the tungsten in place to ensure it does not move during the welding process.

Back caps are made from a rigid phenolic material and generally come in 3 sizes, short, medium and long.

GUIDE TO TIG WELDING



Before starting any welding activity ensure that you have suitable eye protection and protective clothing. Also take the necessary steps to protect any persons within the welding area.

TIG welding electrodes

TIG welding electrodes are a 'non consumable' as it is not melted into the weld pool and great care should be taken not to let the electrode contact the welding pool to avoid weld contamination. This would be referred to as tungsten inclusion and may result in weld failure.

Electrodes will often contain small quantities of metallic oxides which can offer the following benefits:

- Assist in arc starting
- Improve current carrying capacity of the electrode
- Reduce the risk of weld contamination
- Increase electrode life
- Increase arc stability

Oxides used are primarily zirconium, thorium, lanthanum or cerium. These are added usually between 1% to 4%.



Tungsten Electrode Colour Chart - DC

Welding Mode	Tungsten Type	Colour
DC or AC/DC	Ceriated 2%	Grey
DC or AC/DC	Lanthanated 1%	Black
DC or AC/DC	Lanthanated 1.5%	Gold
DC or AC/DC	Lanthanated 2%	Blue
DC	Thoriated 1%	Yellow
DC	Thoriated 2%	Red

Tungsten Electrode Current Ranges

Tungsten Electrode Size	DC Current Amp
1.0mm	30 - 60
1.6mm	60 - 115
2.4mm	100 - 165
3.2mm	135 - 200
4.0mm	190 - 280
4.8mm	250 - 340

Tungsten electrode preparation - AC and DC

When welding at low current the electrode can be ground to a point. At a higher current a small flat on the end of the electrode is preferable as this helps with arc stability.

A balled tip is generally used with the AC welding process. To ball the end of the tungsten properly, simply apply the AC amperage recommended for a given electrode diameter and a ball will form on the end of the electrode.

Electrode grinding

It is important when grinding the electrode to take all necessary precautions such as wearing PPE such as eye protection and ensuring adequate protection against breathing in any grinding dust.

Tungsten electrodes should always be ground lengthwise (as shown) and not in a radial operation. Electrodes ground in a radial operation tend to contribute to arc wander due to the arc transfer from the grinding pattern. Always use a grinder solely for grinding electrodes to avoid contamination.

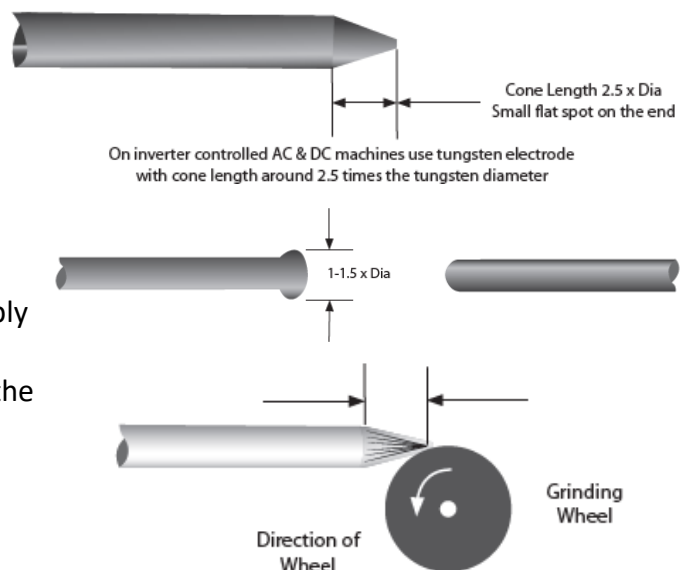

GUIDE TO TIG WELDING



Before starting any welding activity ensure that you have suitable eye protection and protective clothing. Also take the necessary steps to protect any persons within the welding area.

TIG welding consumables

The consumables of the TIG welding process are filler wires and shield gas.

Filler wires

Filler wires come in many different material types and usually as cut lengths, unless some automated feeding is required where it will be in reel form. Filler wire is generally fed in by hand. Always consult the manufacturer's data and welding requirements.

Filler Wire Diameter	DC Current Range (Amps)
1.0mm	20-90
2.4mm	65-115
3.2mm	100-165
4.8mm	200-350

Filler Wire Selection Guide

Gases

Shielding gas is required when welding to keep the weld pool free of oxygen. Whether you are welding mild steel or stainless steel the most commonly used shielding gas used in TIG welding is argon, for more specialised applications an argon helium mix or pure helium may be used.

TIG welding - arc starting

The TIG process can use both non contact and contact methods to provide arc starting. Depending on the Jasic model, the options are indicated on a selector switch on the front control panel of the power source. The most common method of arc starting is 'HF' start. This term is often used for a variety of starting methods and covers many different types of start.

Arc starting - scratch start

This system is where the electrode is scratched along the work piece like striking a match. This is a basic way of turning any DC stick welder into a TIG welder without much work. It is not considered suitable for high integrity welding due to the fact that the tungsten can be melted on the work piece thereby contaminating the weld.

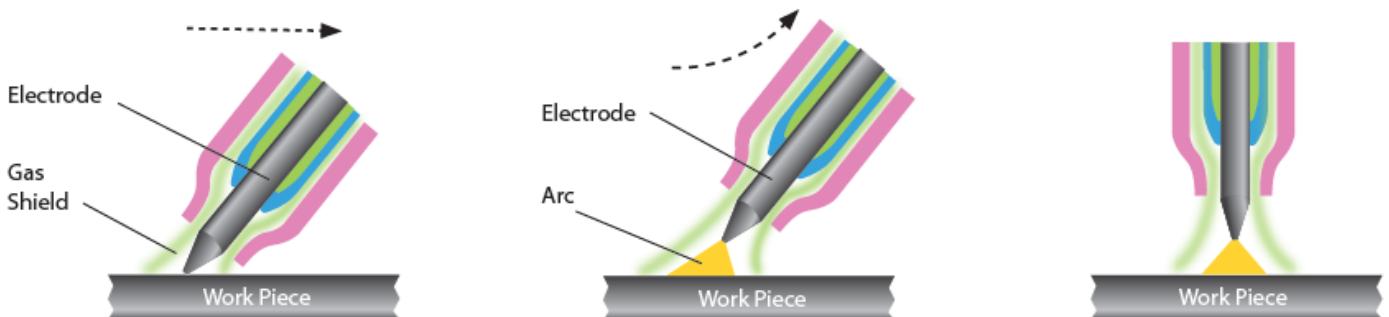

The main challenge with scratch start TIG welding is keeping your electrode clean. While a quick strike with the electrode on the metal is essential and then not lifting it more than 3mm away to create the arc will help, you also need to ensure your metal is completely clean.

GUIDE TO TIG WELDING



Before starting any welding activity ensure that you have suitable eye protection and protective clothing. Also take the necessary steps to protect any persons within the welding area.

Arc starting - lift TIG (lift arc)

Not to be confused with scratch start, this arc starting method allows the tungsten to be in direct contact with the work piece first but with minimal current so as not to leave a tungsten deposit when the tungsten is lifted and an arc is established.

With lift TIG start the open circuit voltage (OCV) of the welder folds back to a very low voltage output when the unit senses the tungsten has made continuity with the work piece. Once the torch is lifted the unit increases output as the tungsten leaves the surface. This creates little contamination and preserves the point on the tungsten although this is still not a 100% clean process. The tungsten still can get contaminated but lift TIG is a much better option than scratch starting for mild and stainless steel although these methods of arc starting are not a good option when welding aluminium.

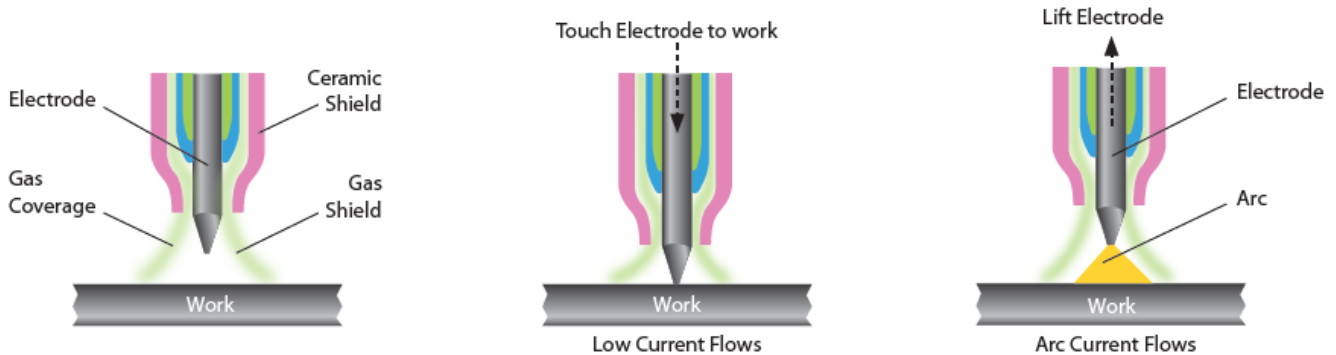

Arc starting - HF start

Non contact High Frequency (HF) start method is a high voltage and low amperage generated using a spark gap assembly and is the most popular and generally considered best TIG arc starting method. The High Frequency (HF) start generates a high frequency arc that ionizes the gas bridging the gap between the tungsten point and the work piece. This touchless method creates almost no contamination unless the tungsten has been over sharpened or the start amperage is too high. It is an excellent choice for all material being welded especially aluminium although, unless you need to weld aluminium, you don't have to use HF start steel/stainless.

The HF frequency varies with the spark gap and can be around 16000 Hz to 100000 Hz depending on spark gap width so consideration should be given with this method as it can cause electrical interference to nearby electrical equipment such as computers, CNC controls and phone systems.

If the spark gap is widened, the HF can become erratic.



GUIDE TO DC TIG WELDING



Before starting any welding activity ensure that you have suitable eye protection and protective clothing. Also take the necessary steps to protect any persons within the welding area.

DC TIG welding

Direct current welding is when the current flows in one direction only. Compared with AC welding the current once flowing will not go to zero until welding has ended.

The Jasic TIG Series polarity should generally be set up for Direct Current - Electrode Negative (DCEN) as this method of welding can be used for a wide range of materials.

The TIG welding torch is connected to the negative output of the machine and the work return cable to the positive output.

When the arc is established the current flows in the circuit and the heat distribution in the arc is around 33% in the negative side of the arc (the welding torch) and 67% in the positive side of the arc (the work piece). This balance gives deep arc penetration of the arc into the work piece and reduces heat in the electrode.

This reduced heat in the electrode allows more current to be carried by smaller electrodes compared to other polarity connections. This method of connection is often referred to as straight polarity and is the most common connection used in DC welding.

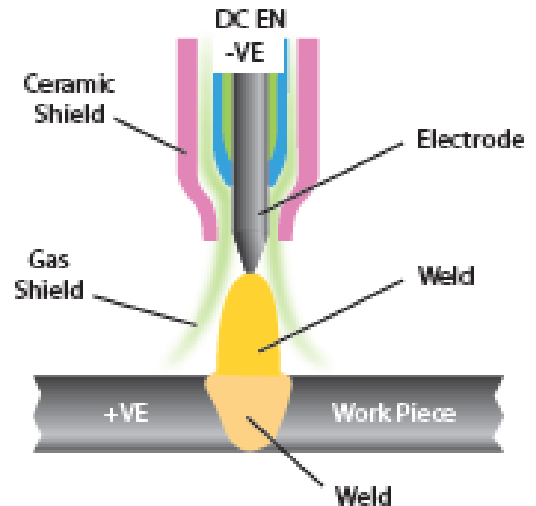

TIG welding techniques

- Before welding (especially with mild steel) you should ensure all material being welded are clean, as particulates can weaken the weld.
- The torch angle is best kept at 15 - 20° (from vertical) away from the direction of travel. This assists with visibility of the weld area and allows easier access for the filler material.
- The filler metal should be fed in at a low angle to help avoid touching the tungsten electrode and contaminating it.
- The TIG welding arc melts the base material and the molten puddle melts the filler rod, it is important you resist the urge to melt the filler material directly into the welding arc.
- For thinner sheet materials, a filler material may not be needed.
- Prepare the tungsten correctly, using a diamond grinding wheel will give you the best results for a sharp point (see page 35).
- For welding stainless steel, be careful of applying too much heat. If the colour is dark grey and looks dirty and heavily oxidized then too much heat has been applied, this could also cause the material to warp. Reducing the amperage and increase travel speed may correct this problem, you could also consider using a smaller diameter filler material, as that will require less energy to melt.

See the following page for a TIG DC welding amperage guide

GUIDE TO DC TIG WELDING



Before starting any welding activity ensure that you have suitable eye protection and protective clothing. Also take the necessary steps to protect any persons within the welding area.

Manual DC TIG Welding Amperage Guide- Mild Steel and Stainless Steel

Base Metal Thickness mm	Base Metal Thickness Inch	Tungsten Electrode Diameter	Output Polarity	Filler Wire Diameter (If Required)	Argon Gas Flow Rate (Litres/Min)	Joint Types	Amperage Range
1.6mm	1/16"	1.6mm	DC	1.6mm	5 - 8	Butt	50 - 80
1.6mm	1/16"	1.6mm	DC	1.6mm	5 - 8	Corner	50 - 80
1.6mm	1/16"	1.6mm	DC	1.6mm	5 - 8	Fillet	60 - 90
1.6mm	1/16"	1.6mm	DC	1.6mm	5 - 8	Lap	60 - 90
2.4mm	3/32"	1.6/2.4mm	DC	1.6/2.4mm	5 - 9	Butt	80 - 110
2.4mm	3/32"	1.6/2.4mm	DC	1.6/2.4mm	5 - 9	Corner	80 - 110
2.4mm	3/32"	1.6/2.4mm	DC	1.6/2.4mm	5 - 9	Fillet	90 - 120
2.4mm	3/32"	1.6/2.4mm	DC	1.6/2.4mm	5 - 9	Lap	90 - 120
3.2mm	1/8"	2.4mm	DC	2.4mm	5 - 10	Butt	80 - 120
3.2mm	1/8"	2.4mm	DC	2.4mm	5 - 10	Corner	90 - 120
3.2mm	1/8"	2.4mm	DC	2.4mm	5 - 10	Fillet	100 - 140
3.2mm	1/8"	2.4mm	DC	2.4mm	5 - 10	Lap	100 - 140
4.8mm	3/16"	2.4mm	DC	2.4mm	6 - 11	Butt	120 - 200
4.8mm	3/16"	2.4mm	DC	2.4mm	6 - 11	Corner	150 - 200
4.8mm	3/16"	2.4mm	DC	2.4mm	6 - 11	Fillet	170 - 220
4.8mm	3/16"	2.4mm	DC	2.4mm	6 - 11	Lap	150 - 200
6.4mm	1/4"	2.4mm	DC	3.2mm	7 - 12	Butt	225 - 300
6.4mm	1/4"	2.4mm	DC	3.2mm	7 - 12	Corner	250 - 300
6.4mm	1/4"	2.4mm	DC	3.2mm	7 - 12	Fillet	250 - 320
6.4mm	1/4"	2.4mm	DC	3.2mm	7 - 12	Lap	250 - 320
9.5mm	3/8"	3.2mm	DC	3.2mm	7 - 12	Butt	250 - 360
9.5mm	3/8"	3.2mm	DC	3.2mm	7 - 12	Corner	260 - 360
9.5mm	3/8"	3.2mm	DC	3.2mm	7 - 12	Fillet	270 - 380
9.5mm	3/8"	3.2mm	DC	3.2mm	7 - 12	Lap	230 - 380
12.7mm	1/2"	3.2/4mm	DC	3.2mm	8 - 13	Butt	300 - 400
12.7mm	1/2"	3.2/4mm	DC	3.2mm	8 - 13	Corner	320 - 420
12.7mm	1/2"	3.2/4mm	DC	3.2mm	8 - 13	Fillet	320—420
12.7mm	1/2"	3.2/4mm	DC	3.2mm	8 - 13	Lap	320 - 420

Please Note:

- All above guide settings are approximate and will vary depending on application, prep, passes and type of welding equipment used.
- The welds would need to be tested to ensure they comply to your welding specifications.

TIG TORCH SPARE PARTS LIST



TIG Welding Torch Air Cooled - Model TIG71 (Type WP17)

Rating 150A DC, 115A AC @ 60% Duty Cycle EN60974-7 • 0.5mm to 3.2mm Electrodes

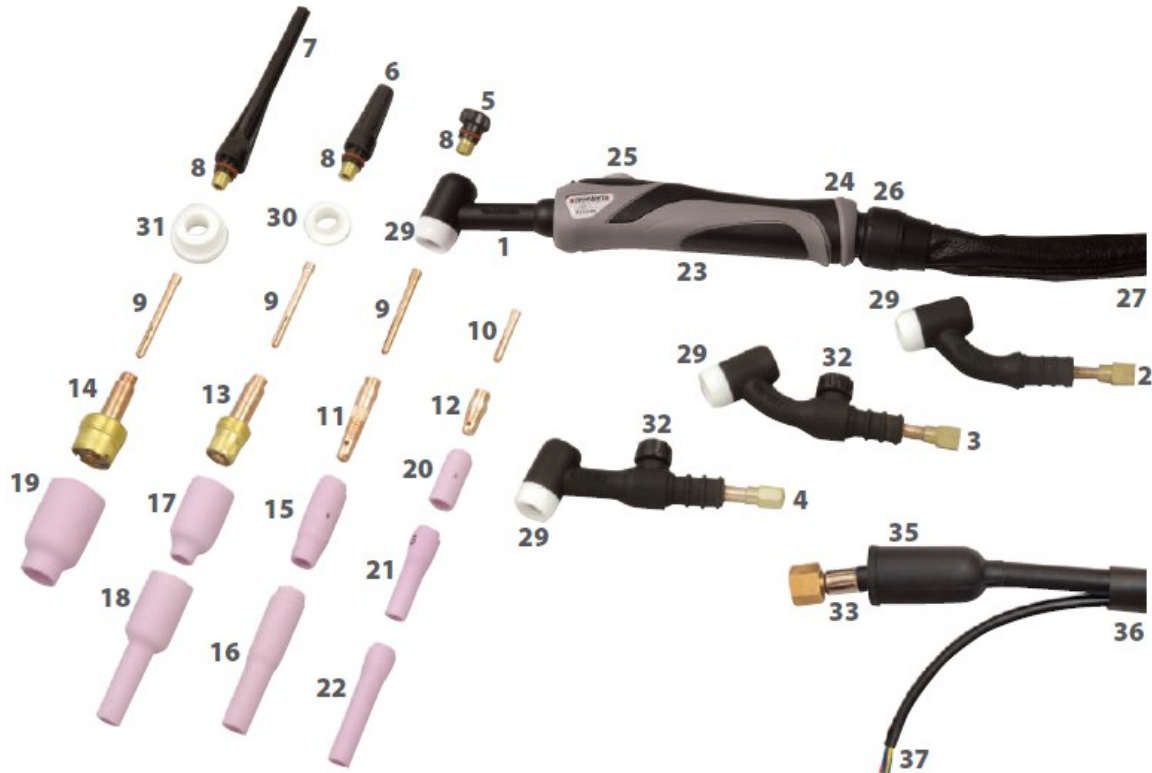

Main Consumables

No	Code	Description
1	WP17	Rigid Torch Body
2	WP17F	Flexible Torch Body
3	WP17FV	Flexible Torch Body c/w Valve
4	WP17V	Torch Body c/w Argon Valve
5	57Y04	Short Back Cap
6	300M	Medium Back Cap
7	57Y02	Long Back Cap
8	98W18	Back Cap 'O' Ring

Collets

9	10N21	Standard .020" (0.5mm)
	10N22	Standard .040" (1.0mm)
	10N23	Standard 1/16" (1.6mm)
	10N26	Standard 5/64" (2.0mm)
	10N24	Standard 3/32" (2.4mm)
	10N25	Standard 1/8" (3.2mm)
10	10N21S	Stubby .020" (0.5mm)
	10N22S	Stubby .040" (1.0mm)
	10N23S	Stubby 1/16" (1.6mm)
	10N24S	Stubby 3/32" (2.4mm)
	10N25S	Stubby 1/8" (3.2mm)

Collet Bodies

11	10N29	Standard .020" (0.5mm)
	10N30	Standard .040" (1.0mm)
	10N31	Standard 1/16" (1.6mm)
	10N31M	Standard 5/64" (2.0mm)
	10N32	Standard 3/32" (2.4mm)
	10N28	Standard 1/8" (3.2mm)
12	17CB20	Stubby .020"- 1/8" (0.5 - 3.2mm)

Gas Lens Bodies

13	45V29	Standard .020" (0.5mm)
	45V24	Standard .040" (1.0mm)
	45V25	Standard 1/16" (1.6mm)
	45V25M	Standard 5/64" (2.0mm)
	45V26	Standard 3/32" (2.4mm)
	45V27	Standard 1/8" (3.2mm)

Gas Lens Bodies

14	45V0204	Large Dia .020"-.040" (0.5 - 1.0mm)
	45V116	Large Dia 1/16" (1.6mm)
	45V64	Large Dia 3/32" (2.4mm)
	995795	Large Dia 1/8" (3.2mm)

Ceramic Cups

15	10N50	Standard Cup 1/4" Bore
	10N49	Standard Cup 5/16" Bore
	10N48	Standard Cup 3/8" Bore
	10N47	Standard Cup 7/16" Bore
	10N46	Standard Cup 1/2" Bore
	10N45	Standard Cup 5/8" Bore
	10N44	Standard Cup 3/4" Bore
16	10N50L	Long Cup 1/4" Bore
	10N49L	Long Cup 5/16" Bore
	10N48L	Long Cup 3/8" Bore
	10N47L	Long Cup 7/16" Bore

Gas Lens Cups

17	54N18	Standard Cup 1/4" Bore
	54N17	Standard Cup 5/16" Bore
	54N16	Standard Cup 3/8" Bore
	54N15	Standard Cup 7/16" Bore
	54N14	Standard Cup 1/2" Bore
	54N19	Standard Cup 11/16" Bore
18	54N17L	Long Cup 5/16" Bore
	54N16L	Long Cup 3/8" Bore
	54N15L	Long Cup 7/16" Bore
	54N14L	Long Cup 1/2" Bore
19	57N75	Large Dia Cup 3/8" Bore
	57N74	Large Dia Cup 1/2" Bore
	53N88	Large Dia Cup 5/8" Bore
	53N87	Large Dia Cup 3/4" Bore

Ceramic Cups for use with item 12

No	Code	Description
20	13N08	Standard Cup 1/4" Bore
	13N09	Standard Cup 5/16" Bore
	13N10	Standard Cup 3/8" Bore
	13N11	Standard Cup 7/16" Bore
	13N12	Standard Cup 1/2" Bore
	13N13	Standard Cup 5/8" Bore
21	796F70	Long Cup 3/16" Bore
	796F71	Long Cup 1/4" Bore
	796F72	Long Cup 5/16" Bore
	796F73	Long Cup 3/8" Bore
22	796F74	X - Long Cup 3/16" Bore
	796F75	X - Long Cup 1/4" Bore
	796F76	X - Long Cup 5/16" Bore
	796F77	X - Long Cup 3/8" Bore

Secondary Consumables

23	SP9110	LH & RH Handle Shell
24	SP9111	Handle Screw
25	SP9120	Single Button Switch
	SP9121	2 Button Switch
	SP9122	5K Potentiometer Switch
	SP9123	10K Potentiometer Switch
	SP9128	47K Potentiometer Switch
	SP9129	4 Button Switch
26	SP9113	Handle Ball Joint
27	SP9116	Leather Cover 800mm
28	SP9118	Cable Cover Joint (not illustrated)
29	18CG	Standard Heat Shield
30	54N01	Gas Lens Heat Shield
31	54N63	Large Gas Lens Insulator
32	VS-2	Valve Stem WP17V & WP17FV
33	57Y01	Mono Power Cable 12.5ft - 3/8"
	57Y03	Mono Power Cable 25ft - 3/8" Bsp
34	57Y01-2D	2 Piece Power Cable Assy 12.5ft
	57Y03-2D	2 Piece Power Cable Assy 25ft
35	0315071	Insulation Boot
36	SP9002	Neoprene Protective Cover 1m
37	SP9126	4m Switch Cable
	SP9127	8m Switch Cable
--	JSP-01	2 Pin Control Plug (TIG Torch)
--	1004655	5 Pin Control Plug (TIG Torch)

TIG WELDING PROBLEMS



Before starting any welding activity ensure that you have suitable eye protection and protective clothing. Also take the necessary steps to protect any persons within the welding area.

TIG welding defects and prevention methods

<u>Defect</u>	<u>Possible cause</u>	<u>Action</u>
Excessive tungsten use	Set up for DCEP	Change to DCEN
	Insufficient shield gas flow	Check for gas restriction and correct flow rates. Check for drafts in the weld area.
	Electrode size too small	Select correct size
	Electrode contamination during cooling time	Extend post flow gas time
Porosity/weld contamination	Loose torch or hose fitting	Check and tighten all fitting
	Inadequate shield gas flow	Adjust flow rate - normally 8-12L/m
	Incorrect shield gas	Use correct shield gas
	Gas hose damaged	Check and repair any damaged hoses
	Base material contaminated	Clean material properly
	Incorrect filler material	Check correct filler wire for grade of use
No operation when torch switch is operated	Torch switch or cable faulty	Check the torch switch continuity and repair or replace as required
	ON/OFF switch turned off	Check position of ON/OFF switch
	Mains fuses blown	Check fuses and replace as required
	Fault inside the machine	Call for a repair technician
Low output current	Loose or defective work clamp	Tighten/replace clamp
	Loose cable plug	Check and tighten all plugs
	Power source faulty	Call a repair technician
High frequency will not strike the arc	Weld/power cable open circuit	Check all cables and connections for continuity, especially the torch cables
	No shield gas flowing	Check cylinder contents, regulator and valves, also check the power source
Unstable arc when welding in DC	Tungsten contaminated	Break off contaminated end and regrind the tungsten
	Arc length incorrect	Arc length should be between 3-6mm
	Material contaminated	Clean all base and filler material
	Electrode connected to the wrong polarity	Reconnect to correct polarity
Arc is difficult to start	Incorrect tungsten type	Check and fit correct tungsten
	Incorrect shield gas	Use argon shield gas

TIG WELDING PROBLEMS



Before starting any welding activity ensure that you have suitable eye protection and protective clothing. Also take the necessary steps to protect any persons within the welding area.

TIG welding defects and prevention methods

<u>Defect</u>	<u>Possible cause</u>	<u>Action</u>
Excessive bead build up, poor penetration or poor fusion at the edges of the weld	Weld current too low	Increase the welding amperage Poor material prep
Weld bead flat and too wide or undercut at the weld edge or burning through	Weld current too high	Decrease the welding amperage
Weld bead too small or insufficient penetration	Welding travel speed too fast	Reduce your welding travel speed
Weld bead too wide or excessive bead build up	Welding travel speed too slow	Increase your welding travel speed
Uneven leg length in fillet joint	Wrong placement of filler rod	Re-position filler rod
Tungsten melts or oxidises when welding arc is made	TIG torch lead connected to + Little or no gas flow to weld pool Gas cylinder or hoses contain impurities The tungsten is too small for the weld current TIG/MMA selector set to MMA	Connect to - polarity Check gas apparatus as well as torch and hoses for breaks or restrictions Change gas cylinder and blow out torch and gas hoses Increase the size of the tungsten Ensure you have the power source set to TIG function

MAINTENANCE



The following operation requires sufficient professional knowledge on electric aspects and comprehensive safety knowledge. Make sure the input cable of the machine is disconnected from the electricity supply and wait for 5 minutes before removing the machine covers.

In order to guarantee that the arc welding machine works efficiently and in safety, it must be maintained regularly. Operators should understand the maintenance methods and means of arc welding machine operation. This guide should enable customers to carry out simple examination and safeguarding by themselves, and to reduce the fault rate and repair times of the arc welding machine, so as to lengthen the service life of the arc welding machine.

Period

Maintenance item

Daily examination	<ul style="list-style-type: none"> • Check the condition of the machine, mains cables, welding cables and connections. • Check for any warnings LEDs and machine operation.
Monthly examination	<ul style="list-style-type: none"> • Disconnect from the mains supply and wait for at least 5 minutes before removing the cover. • Check internal connections and tighten if required. • Clean the inside of the machine with a soft brush and vacuum cleaner. • Take care not to remove any cables or cause damage to components. • Ensure that ventilation grills are clear. • Carefully replace the covers and test the unit. <p>This work should be carried out by a suitably qualified competent person.</p>
Yearly examination	<ul style="list-style-type: none"> • Carry out an annual service to include a safety check in accordance with the manufacturers standard (EN 60974-1). <p>This work should be carried out by a suitably qualified competent person.</p>

⇒ Ensure the power is disconnected before working on the machine.

⇒ Always wait 5 minutes after power switch off before opening the case.

SERVICE SCHEDULE RECORD

Date	Type of service and work carried out	Serviced by	Due date for next check

TROUBLESHOOTING



The following operation requires sufficient professional knowledge on electric aspects and comprehensive safety knowledge. Make sure the input cable of the machine is disconnected from the electricity supply and wait for 5 minutes before removing the machine covers.

Before arc welding machines are dispatched from the factory, they have already been checked thoroughly. The machine should not be tampered with or altered. Maintenance must be carried out carefully. If any wire becomes loose or is misplaced, it maybe potentially dangerous to the user!

Only professional maintenance personnel should repair the machine!

Ensure the power is disconnected before working on the machine. Always wait 5 minutes after power switch off before removing the panels.

Description of fault	Possible cause
The power LED is OFF and the fan is not functioning	The primary supply voltage has not been switched ON or input fuse has blown The welding power source input switch is switched OFF Loose connections internally
The fault LED is ON and the fan is running	The machine is under over-heating protection status and will recover automatically after the welding machine has cooled down Check incoming mains supply to ensure it is within 230V +/- 15%
No high frequency is produced	Process selection switch is set to manual metal arc (MMA) Torch trigger switch lead is disconnected or switch/lead is faulty High frequency spark gap too wide or short circuited
Welding current reduces when welding	Poor work lead connection to the work piece
TIG electrode melts when arc is struck	TIG torch is connected to the (+) VE terminal
No gas flow when the TIG torch trigger switch is depressed	Empty gas cylinder Gas regulator is turned off Gas hose is blocked or cut Torch trigger switch lead is disconnected or switch/lead is faulty
Difficult to ignite the arc	The arc ignition current is too low or the arc ignition time is too short
The electrode holder becomes very hot	The rated current of the electrode holder is smaller than its actual working current, replace it with a higher rated current capacity
Excessive spatter in MMA welding	The output polarity connection is incorrect, exchange the polarity
Other malfunction	Contact your supplier

WEEE disposal

The equipment is manufactured with materials which do not contain any toxic or poisonous materials dangerous to the operator.

When the equipment is scrapped, it should be dismantled separating components according to the type of materials.

Do not dispose of the equipment with normal waste. The European Directive 2002/96/EC and United Kingdom's Directive The Waste Electrical and Electronic Equipment (WEEE) regulations 2013 states that electrical equipment that has reached its end of life must be collected separately and returned to an environmentally compatible recycling facility.

Jasic has a relevant recycling system which is compliant and registered in the UK with the environment agency. Our registration reference is WEEMM3813AA.

In order to comply with WEEE regulations outside the UK you should contact your supplier.

RoHS Compliance Declaration

We herewith confirm, that the above mentioned product does not contain any of the restricted substances as listed in EU Directive 2011/65/EU and the UK directive ROHS Regulations 2012 in concentrations above the limits as specified therein.

UKCA Declaration of Conformity

The manufacturer, or its legal representative Wilkinson Star Limited, declares that the equipment described below is designed and produced according to following UK legislation:

- Electrical equipment safety 2016
- Electromagnetic compatibility (EMC) regulations 2016
- The restrictions of the use of certain hazardous substances in electrical and electronic equipment regulations 2012

And inspected according to following designated standards:

- EN 60 974-1:2018+A1:2019
- EN 60 974-10:2014+A1:2015

Any alteration or change to these machines by any unauthorized person makes this declaration invalid.

Model:

JT-200P

Authorised Representative:

Wilkinson Star Limited
Shield Drive
Wardley Industrial Estate
Worsley
Manchester
M28 2WD

Disclaimer:

Please note that this confirmation is given to the best of our present knowledge and belief. Nothing herein represents and/or may be interpreted as warranty within the meaning of the applicable warranty law.

EC Declaration of Conformity

EC DECLARATION OF CONFORMITY

The manufacturer, or its legal representative **Wilkinson Star Limited**, declares that the equipment described below is designed and produced according to following EU Directives:

- Low Voltage Directive (LVD), No.: 2014/35/EU
- Electromagnetic compatibility (EMC) Directive, No.: 2014/30/EU

And inspected according to following

EU - Norms:

- EN 60 974-1:2012
- EN 60 974-10:2014+A1

Any alteration or change to these machines by any unauthorized person makes this Declaration invalid.

Wilkinson Star model
JT-200P PFC

Jasic Model
TIG 200P DC PFC (W218)

Authorised Representative

Wilkinson Star Limited
Shield Drive, Wardley Industrial Estate,
Worsley, Manchester M28 2WD
Tel 0161 793 8127

Manufacturer

Shenzhen Jasic Technology Co LTD
No3 Qinglan, 1st Road
Pingshan District
Shenzhen, China

Signature

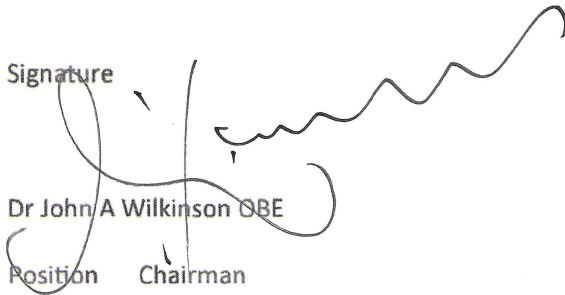

Dr John A Wilkinson OBE

Position Chairman

Signature

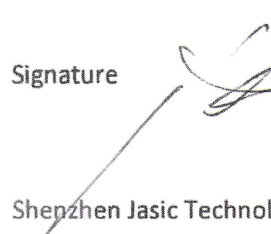

Shenzhen Jasic Technology Co LTD

Position

Date



Date



STATEMENT OF WARRANTY

All new JASIC welders, plasma cutters and multi-process units sold through our partner Wilkinson Star Limited within the United Kingdom and Ireland shall be warranted to the original owner, non transferable, against failure due to defective materials or production. The warranty period is 5 years following the date of purchase. We recommend you register your product within 28 days of purchase. The original invoice is documentation for the standard warranty period. The warranty period is based on a single shift pattern.

Defective units shall be repaired or replaced by the company at our workshop. The company may opt to refund the purchase price (less any costs and depreciation due to use and wear). The company reserves the right to alter the warranty conditions at any time with effect for the future.

A prerequisite for the full warranty is that products are operated in accordance with the operating instructions supplied, observing the relevant installation and any legal requirements recommendations and guidelines and carrying out the maintenance instructions shown in the operator manual. This should be carried out by a suitably qualified competent person.

In the unlikely event of a problem, this should be reported to Jasic technical support team to review the claim.

The customer has no claim to loan or replacement products whilst repairs are being performed.

The following falls outside the scope of the warranty:

- Defects due to natural wear and tear
- Failure to observe the operating and maintenance instructions
- Connection to an incorrect or faulty mains supply
- Overloading during use
- Any modifications that are made to the product without the prior written consent
- Software errors due incorrect operation
- Any repairs that are carried out using non-approved spare parts
- Any transport or storage damage
- Direct or indirect damage as well as any loss of earnings are not covered under the warranty
- External damage such as fire or damage due to natural causes e.g. flooding

NOTE: Under the terms of the warranty, welding torches, their consumable parts, wire feed unit drive rolls and guide tubes, work return cables and clamps, electrode holders, connection and extension cables, mains and control leads, plugs, wheels, coolant etc. are covered with a 3 month warranty.

Jasic shall in no event be responsible for any third party expenses or expenses/costs or any indirect or consequential expenses/costs.

Jasic will submit an invoice for any repair work performed outside the scope of the warranty. A quotation for any non warranty will be raised prior to any repairs being carried out.

The decision about repair or replacement of the defective part(s) is made by Jasic. The replaced part(s) remain(s) Jasic property.

Warranty extends only to the machine, its accessories and parts contained inside. No other warranty is expressed or implied. No warranty is expressed or implied in regards to the fitness of the product for any particular application or use.

For further information on Jasic product warranty terms and product warranty registration please visit:

www.jasic-warranty.co.uk/terms

www.jasic-warranty.co.uk

OPTIONS AND ACCESSORIES

Part Number	Description
TIG-71	Titanium 17 TIG Torch 12.5ft c/w Dinse Adaptor and 5 Pin Switch Plug
TIG-71-8M	Titanium 17 TIG Torch 25ft c/w Dinse Adaptor and 5 Pin Switch Plug
TIG-71-8MFLEXI	Titanium 17F TIG Torch 25ft c/w Flexi Torch Head, Dinse Adaptor and 5 Pin Switch Plug
10004655	TIG Torch Switch Plug (5 Pin)
TIG-37ERGO *	Titanium 17 TIG Torch 12.5ft c/w Dinse Adaptor and 2 Pin Switch Plug
TIG-37FERGO *	Titanium 17F TIG Torch 12.5ft c/w Flexi Torch Head, Dinse Adaptor and 2 Pin Switch Plug
TIG-37-8MERGO *	Titanium 17 TIG Torch 25ft c/w Dinse Adaptor and 2 Pin Switch Plug
TIG-37F-8MERGO *	Titanium 17F TIG Torch 25ft c/w Flexi Torch Head, Dinse Adaptor and 2 Pin Switch Plug
JSP-01 *	TIG Torch Switch Plug (2 Pin)
WCS25-3WEL	Welding Cable Set (MMA) 3m
WC-2-03LD	Electrode Holder and Lead 3m
EC-2-03LD	Work Return Lead and Clamp 3m
CP3550	Cable Plug 35-50mm
JSS-01	Jasic Carry Strap
JSB-01	Jasic Site Bag
JIT-01	Trolley
JH-HDX	Jasic HD True Colour Auto Darkening Welding Helmet
SSARG2G	Single Stage 2 Gauge Argon Regulator
WTLHK2	2m Gas Hose and Quick Gas Connector

* Please Note:

Older JT200P-PFC machines were fitted with a 2 pin control socket where as all new JT200P-PFC units now have a 5 pin control socket.



SCHEMATIC

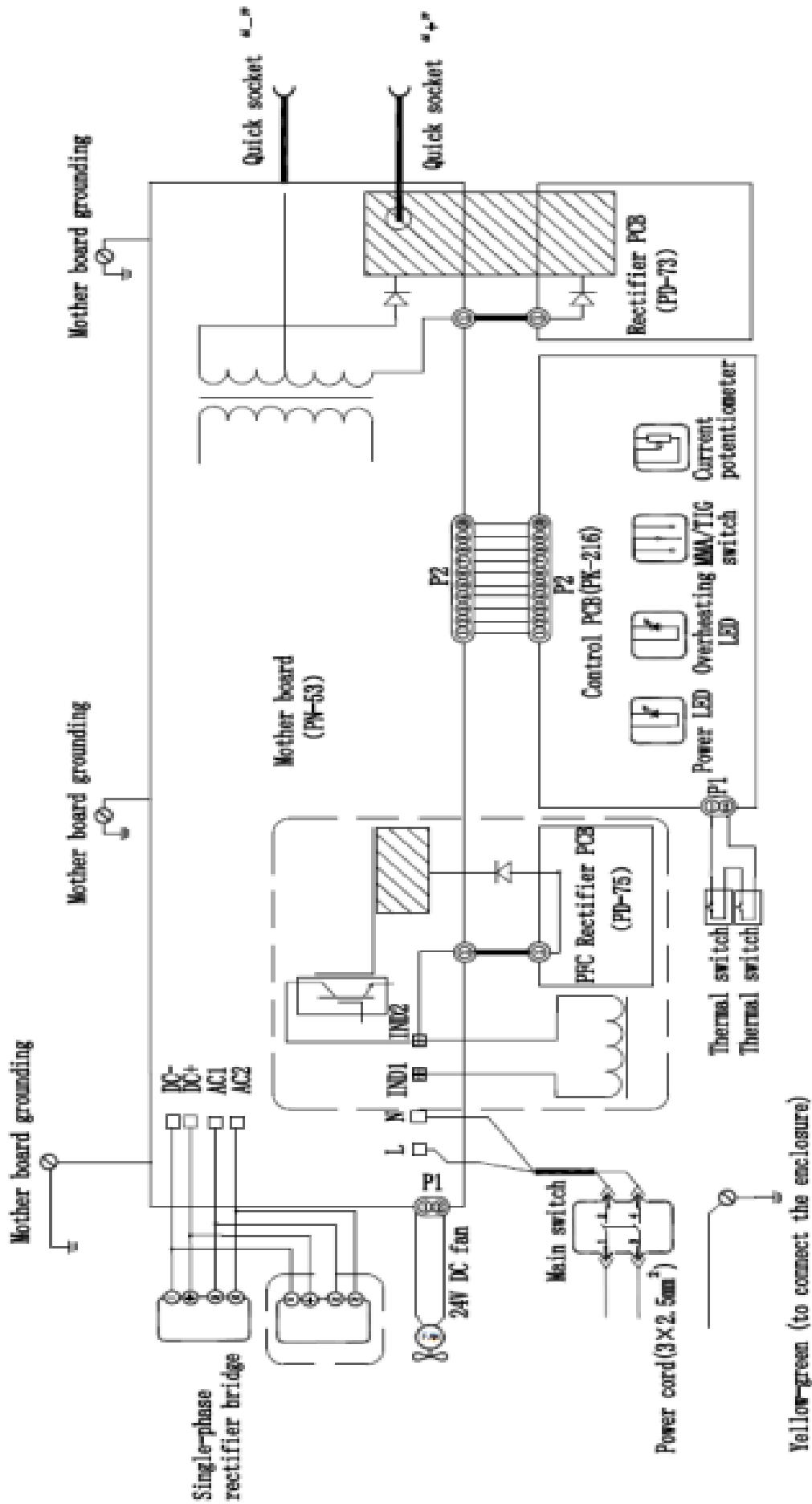

Wilkinson Star Limited

Shield Drive
Wardley Industrial Estate
Worsley
Manchester
UK
M28 2WD

+44 (0)161 793 8127



www.jasic.co.uk
November 2022 - Issue 8