

ProfiMaster, one exhaust arm

Art. No.: 60 650 100



Technical Data

Filter	
Filter stages	2
Filter method	Storage Filter
Filter surface	17 m ²
Type of filter	Filter cassette
Filter material	Non-woven fibre
Filter efficiency	> 99,5 %
Filter class	E12
Additional filters	Pre-filter
Basic data	
Extraction capacity	1100 m ³ /h
Maximum vacuum	2100 Pa
Dimensions (w x t x h)	797 x 828 x 977 mm
Weight	109 kg
Motor power	1.1 kW
Power supply	3 x 400 V / 50 Hz
Rated current	2.3 A
Control voltage	24 V, DC
Noise level	72 dB(A)
Additional information	
IFA-Certification	W3-Approved
Fan type	Radial fan
Quantity of extraction arms	1
Exhaust arm type	flexible exhaust arm
Diameter extraction arm	150 mm
Length of exhaust arm	2 m

Applications

- Suitable for all materials, including high-alloy steel
- Low to medium levels of smoke and dust
- Occasional to frequent use

Benefits

- Safe operation by rotation field control
- Maintenance door allows easy filter change
- Exhaust arm requires less adjustment due to flow-optimised exhaust hood design
- Increased safety due to filter monitoring

Properties

- Exhaust arm up to 4 m
- Rotating exhaust hood

Accessories

- Automatic start-stop



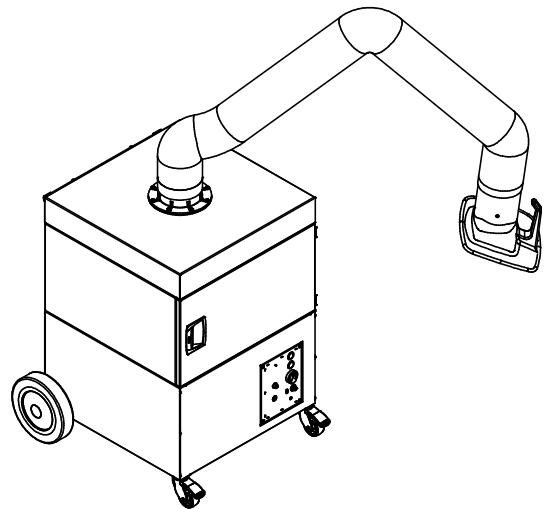
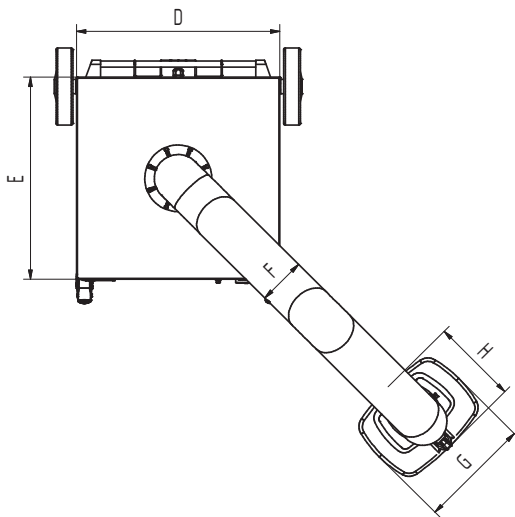
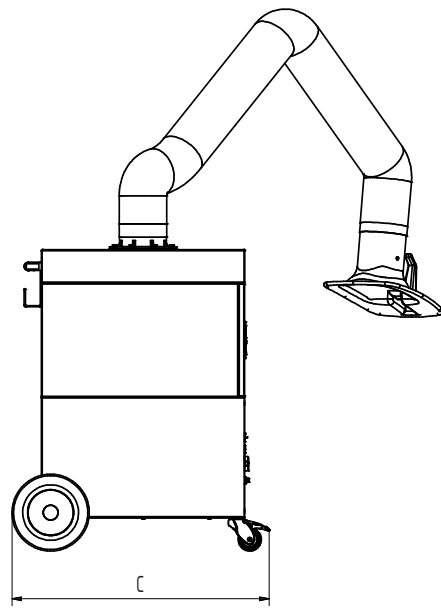
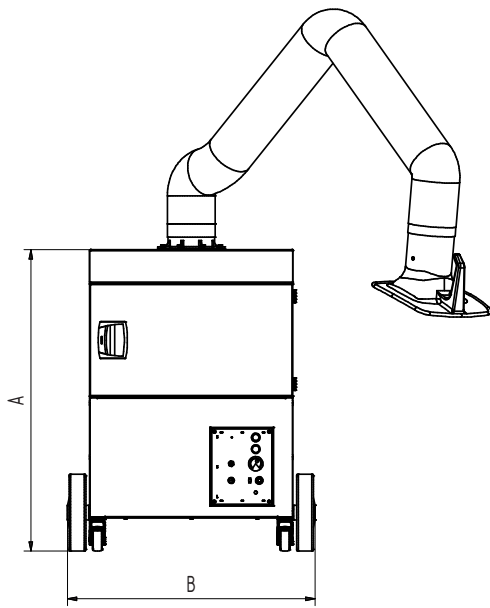

Technical Data

Dimensions

A	977 mm
B	797 mm
C	828 mm
D	655 mm
E	655 mm
F	150 mm
G	360 mm
H	295 mm